

THE UNIVERSITY OF CALGARY
BIOMECHANICAL ANALYSIS OF SHORT TERM PAIN AND INJURIES
IN TENNIS

by

SIMON M. LUETHI

A THESIS
SUBMITTED TO THE FACULTY OF GRADUATE STUDIES
IN PARTIAL FULFILLMENT OF THE REQUIREMENTS FOR THE
DEGREE OF DOCTOR OF PHILOSOPHY

DEPARTMENT OF MEDICAL SCIENCES



CALGARY, ALBERTA

JUNE, 1983

THE UNIVERSITY OF CALGARY
FACULTY OF GRADUATE STUDIES

The undersigned certify that they have read, and recommend to the Faculty of Graduate Studies for acceptance, a thesis entitled, "BIOMECHANICAL ANALYSIS OF SHORT TERM PAIN AND INJURIES IN TENNIS", submitted by Simon M. Luethi, in partial fulfillment of the requirements for the degree of Doctor of Philosophy.

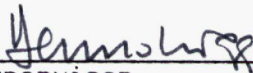

Supervisor,
Benno Nigg,
Faculty of Physical Education.

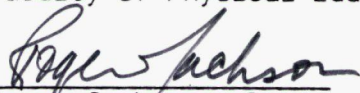

Roger Jackson, Dean
Faculty of Physical Education.

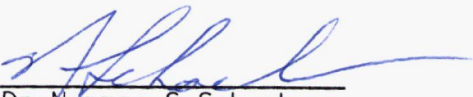

Dr. Norman S. Schachar,
Faculty of Medicine.



Dr. Edgar Stuessi,
Director, ETH Zurich, Switzerland.

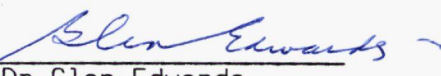

Dr. Glen Edwards,
Faculty of Medicine.

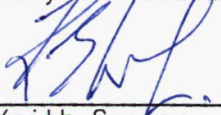

Dr. Keith Cooper,
Vice-President, Research

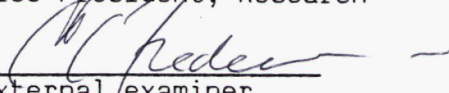

External examiner
Dr. Ned Frederick,
University of New Hampshire

Date: July 7, 1983.

ABSTRACT

The number of tennis players experiencing pain and/or injuries has increased drastically during the last two decades. However, little is known about the etiology of tennis-related pain and injuries in the lower extremities. The purpose of the present study was to analyze systematically the dynamic factors and boundary conditions which influence the frequency of occurrence of pain and/or injuries which occur in the lower extremities as a result of playing the game of tennis. Two groups of factors were studied: the dynamics of the movement and the type of shoe worn (one type with low friction and one type with high friction properties). The method used was a prospective analysis, i.e., all information concerning the movement and boundary conditions was collected from healthy subjects at the beginning of the study. 229 subjects were recruited who then performed three types of test movements: running, running-stopping and hopping sideways. The kinematic and kinetic measurements of these movements were carried out with a Kistler force platform and a Locam II high-speed camera. The subjects then played tennis for a two to three month period (half of the group played with one type of shoe, the others played with the other shoe). After each playing session the subjects had to fill in a "game record" sheet where they recorded the boundary conditions of the game (e.g., type of surface, length of the game, etc.). After a certain period of time some players experienced pain and/or injuries. These players were instructed to make an appointment with a physician of the University of Calgary's health centre in order to get a medical assessment which was recorded on a "medical questionnaire." The biomechanical results of the measurements of the players with pain were then compared to the results of the subjects without pain. The results from the questionnaires showed that the players wearing the hard shoe with high friction were injured more frequently (47.1%) than the players wearing the soft shoe with low friction (32.6%). The site of pain was connected with the type of shoe worn, and the frequency of pain could be related to the type (competitive-recreational) and the

duration of the game. The biomechanical analysis resulted in consistent findings for the three movements studied. All movements had variables which showed significant differences for the pain and the no pain groups. The main findings were:

The type of tennis shoe influences the type and magnitude of the stresses exerted on the lower extremities. The results suggest the assumption that the type of shoe is connected with the occurrence of pain and injuries. The behaviour of subjects in fast sideways movements with sudden changes in direction seem to be related to the occurrence of pain. It was found that the amount of inversion of the foot in this sideways movement was significantly different for subjects with pain compared to subjects without pain. A two dimensional analytical model of the foot was developed in order to explain the experimental result.

The results suggest that a prospective biomechanical analysis of typical movements can be used to establish assumptions concerning the etiology of pain and injuries in sports related activities.

ACKNOWLEDGEMENTS

The author would like to thank Dr. Benno Nigg for his assistance and guidance in this work as well as throughout my professional preparation.

Thanks are also extended to Dr. Roger Jackson for his help and support in the past two years. I am also grateful to Dr. Keith D. Cooper, Dr. Norman S. Schachar, Dr. Glen E. Edwards and Dr. Edgar Stuessi for their helpful suggestions and reviews of the manuscript. I would like to thank Dr. Jack A. Bullard for the examination of the subjects. Special thanks are extended to James Burrett, Roni Fisher and Louise Beauchamp for their technical assistance and for the many hours they have spent to help me with the testing. Much gratitude is expressed to Barbara Lees for typing the final manuscript.

Financial assistance for this thesis was given by a William H. Davies Medical Research Scholarship. Additionally, the study was generously supported by NIKE, Inc. (U.S.A.)

TABLE OF CONTENTS

ABSTRACT	iii
ACKNOWLEDGEMENTS	iv
TABLES OF CONTENTS	vi
LIST OF TABLES	viii
LIST OF FIGURES	ix
1. INTRODUCTION	1
2. LITERATURE AND BASIC CONSIDERATIONS	4
2.1. Literature	4
2.2. Basic considerations	8
2.2.1. Factors influencing load	8
2.2.2. How to determine the etiology of pain and how to assess pain	11
3. METHOD	15
3.1. Symbols used	15
3.2. General remarks	17
3.3. Design of the study	17
3.4. Specific information	19
3.4.1. Test subjects	19
3.4.2. Organizational procedure for test subjects	20
3.4.3. Test shoes	21
3.4.4. Questionnaires	26
3.4.5. Biomechanical measurements	28
3.4.6. Statistical analysis	43
4. RESULTS AND DISCUSSION	44
4.1. General results	44
4.1.1. Description of the population	44
4.1.2. General results concerning pain	46
4.1.3. Summary of general results	52
4.2. Biomechanics	53
4.2.1. Organization of the results	53
4.2.2. Movement 1 (running)	53
4.2.3. Movement 2 (running-stopping)	73
4.2.4. Movement 3 (hopping sideways)	82
4.2.5. Analytical approach for hopping sideways	96
4.2.6. Summary of the biomechanical results	110
4.2.7. Statistical results	113
5. GENERAL REMARKS AND CONCLUSIONS	117

6.	SUMMARY	120
7.	REFERENCES	123
8.	APPENDIX	127

LIST OF TABLES

Table 1.	Symbols used	15
Table 2.	Summary table of the pilot measurements with film and force platform for the shoe selection	25
Table 3.	Test movements chosen for the biomechanical assessment	29
Table 4.	Coding system used for trial identification	33
Table 5.	Summary of the population of the analysis	44
Table 6.	Average, SD, maximum and minimum for age, height and body mass	45
Table 7.	Comparison of the results of shoe 1 and shoe 2 for movement 1	60
Table 8.	Comparison of the results of players with pain and players without pain for running (movement 1)	66
Table 9.	Qualitative comparison of the results of different pain groups to the group without pain	70
Table 10.	Results of selected variables for shoe 1 and shoe 2 for running ~ stopping (movement 2)	75
Table 11.	Comparison of the results of selected variables between test subjects with pain and those without pain	79
Table 12.	Qualitative comparison of the results of different pain groups to the "non-pain" group	80
Table 13.	Comparison of the results between shoe 1 and shoe 2 for hopping sideways (movement 3)	86
Table 14.	Comparison of the results between players with pain and players without pain for hopping sideways (movement 3)	90
Table 15.	Representation of the results for different sites of pain in movement 3	93
Table 16.	Summary of the variables influencing pain in tennis .	111
Table 17.	Variables selected for discriminant analysis	114

LIST OF FIGURES

Figure 1.	Relative frequency of pain and injuries in tennis and relative frequency of publications related to specific pain and injuries	6
Figure 2.	Schematic illustration of factors influencing load on the musculo-skeletal system	9
Figure 3.	Schematic representation of pain reports by test subjects	13
Figure 4.	General design of the study	18
Figure 5.	Results of the static friction coefficient for the six different shoe types for three different temperatures	22
Figure 6.	Maximum free moment of rotation results for one step and a 180 degree turn	24
Figure 7.	Locations of the markers on the shoes and lower extremities and the kinematic variables measured from film	31
Figure 8.	Set-up for the biomechanical tests	32
Figure 9.	Data analysis from cine film measurements	34
Figure 10.	Flow chart for force data processing	35
Figure 11.	Example of the time history of the achilles tendon angle during one foot contact in running	36
Figure 12.	Schematic representation of the force-time curves and the analyzed force variables for movement 1	37
Figure 13.	Representation of an example of the vertical and fore-aft force curves for movement 2 (running-stopping)	38
Figure 14.	Representation of an example of the time history of the achilles tendon angle during the first 30 msec of foot contact	39
Figure 15.	Representation of the kinematic variables for movement 3	40
Figure 16.	Time history of the angle β for one example	41

Figure 17.	Representation of the vertical and lateral ground reaction forces during one foot contact for movement 3	42
Figure 18.	Summary of the percentage with pain during the study for the total group and the subgroups: males and females	47
Figure 19.	Cumulative number of subjects with pain as a function of the playing session	48
Figure 20.	Number of subjects reporting pain as a function of the site of pain	49
Figure 21.	Occurrence of pain for the two shoe groups	50
Figure 22.	Influence of the shoe type on the site of pain	51
Figure 23.	Principle types of vertical force curves for running (movement 1)	54
Figure 24.	Examples of two a-p force curves for running (movement 1)	56
Figure 25.	Types of lateral force curves for running (movement 1)	57
Figure 26.	Curves for the achilles tendon angle β for three different test subjects	58
Figure 27.	Average curves of the achilles tendon angle for shoe 1 and shoe 2	61
Figure 28.	Average vertical force curves and standard deviations for shoe 1 and shoe 2	63
Figure 29.	Average a-p force curves and standard deviations for shoe 1 and shoe 2 (running: heel-toe)	64
Figure 30.	Average lateral force curves and standard deviations for shoe 1 and shoe 2 (running: heel-toe).	65
Figure 31.	Relative frequency of impact peak forces in running with two different tennis shoes	68
Figure 32.	Total pronation/supination of the foot during ground contact for the two shoes	69
Figure 33.	Examples of typical vertical and a-p ground reaction forces for running-stopping (movement 2) for three different subjects	74

Figure 34.	Average vertical force curves and standard deviations for shoe 1 and shoe 2 for running-stopping (movement 2)	76
Figure 35.	Average a-p force curves and standard deviations for shoe 1 and shoe 2 for running-stopping (movement 2)	77
Figure 36.	Typical vertical and lateral force curves for hopping sideways (movement 3) for three different subjects	83
Figure 37.	The geometry of the foot and lower leg before contact and the position of "maximum inversion" of the foot in hopping sideways (movement 3)	84
Figure 38.	The time history of the achilles tendon angle indicating inversion of the foot during the first 50 msec of foot contact	87
Figure 39.	Average vertical force curves and standard deviations for shoe 1 and shoe 2 for hopping sideways (movement 3)	88
Figure 40.	Average lateral force curves and standard deviations for shoe 1 and shoe 2 for hopping sideways (movement 3)	89
Figure 41.	Representation of the effect of inversion of the foot on the occurrence of pain	92
Figure 42.	Total inversion of foot during the first 50 msec of heel contact for different pain groups in movement 3	94
Figure 43.	Inversion of foot produced by moments at the ankle ..	97
Figure 44.	Actual ground reaction force curves and force curve used in calculations	100
Figure 45.	Free body diagram for the calcaneus in the frontal plane	101
Figure 46.	Comparison of the calculated internal forces for the group with shoe 1 and the group with shoe 2	106
Figure 47.	Calculated maximum internal forces for different degrees of inversion	107

Figure 48.	Calculated internal forces for the groups with pain and the groups without pain	108
Figure 49.	Calculated maximum internal forces as a function of different spring constants k_{ER}	109

1. INTRODUCTION

In the past twenty years there has been a remarkable increase in the popularity of tennis. This sport which in many countries was once open only to a small privileged class has become very popular. Recent technological advances in all areas of the game, including court surface and court coverings, have allowed this sport to be played on a year-round basis. The two standard types of surfaces, clay and grass, have been replaced, in many cases, by maintenance-free surfaces such as concrete, asphalt or synthetic materials. The equipment of the players, sport shoe and racket, have undergone rapid developments as well. New materials for the construction of rackets have been introduced (metal, fiberglass) and many players who used to play with gut strings have changed to nylon strings. Sport shoe manufacturers have become aware that the variation in playing surfaces demands different shoe constructions. It seems evident that a shoe which is used for playing on a clay surface where sliding movements can easily be performed has to be constructed differently than a shoe which is used on a concrete surface where hardly any sliding movements occur.

As a result of these technological advances, the intensity of the game has increased drastically for all groups of players. The introduction of indoor tennis has expanded the summer season sport into a year-round sport. The frequency of tennis tournaments offered to all levels of players has increased and an average of ten hours of tennis per week for so-called "recreational" players is not rare. In addition, tennis is a game which can be played by people from about the age of five onward.

However, the growth in popularity and the increase in the length of the playing season as well as the introduction of new materials has not been without its drawbacks. The number of medical problems connected with this sport and the number of players experiencing discomfort, pain or injury has increased significantly (Priest et al., 1980).

Complaints concern different parts of the body such as upper and lower extremities and the trunk. Statistical analysis (Biener and Caluori, 1977; Kraemer and Schmitz-Beuting, 1979; and Nigg and Denoth, 1980) indicates that impairments occur in almost every structure of the musculo-skeletal system. This implies that the mechanical load which acts upon the musculo-skeletal system or parts of it is too big for a large number of tennis players. A consequent overloading of one or more structures may result in either short-term pain or acute injuries or chronic long-term pain. The etiology of both short-term and long-term pain as well as the factors which determine and influence the mechanical load upon the body during tennis activity has not yet been investigated properly. Relatively little is known about the aspects of discomfort, pain and injury in tennis which means that an analysis of these factors is an area for further investigations.

Statement of purposes

The purpose of this study is to contribute to the understanding of the etiology of pain, discomfort and/or injuries in the lower extremities while playing tennis. The special objectives are:

- 1) to establish the kinematic and kinetic variables that describe the differences in dynamic behaviour between test subjects with pain and those without pain in the healthy situation.
- 2) to give a functional explanation of these differences.
- 3) to describe the influence of different types of shoe construction on the frequency and type of pain or specific injuries which occur while playing tennis.

Scope of the study and limitations

It was the intention to recruit a relatively large sample of test subjects with a wide range of skill level and age. In order to get information about the etiology of pain, only subjects who were free from pain and injuries at the beginning of the test period were accepted in the study. Pain, besides those due to acute injuries, can be generally classified as short-term and long-term pain. Short-term pain is the type of pain which is the result of a "new situation" for a tennis player. This may be the case if a player, for instance, changes to a different type of playing surface or is wearing new shoes. This type of pain occurs within the first two months after the change. Long-term pain develops over a longer time and very often results in a chronic type of pain. It can be the result of a frequent overloading of some part of the musculo-skeletal system or could result from the persisting effects of a single injury.

The experimental part of the present study covered a three month period. Therefore the type of pain discussed belongs to the category of short-term pain. It is evident that an analysis of the load on the body of a tennis player can never fully encompass all possible sources of overload, and, therefore this study will only focus on a few critical areas which are of special interest.

2. LITERATURE AND BASIC CONSIDERATIONS

2.1 Literature

A review of the literature dealing with tennis-related pain and injury shows that the number of publications both in research and popular journals has increased during the past two decades. This goes hand in hand with the explosive increase in the number of tennis players during the same time. Tennis, a sport which once was not interesting to researchers in the fields of sports medicine and biomechanics, has now attracted the attention of a number of people working in these fields. The substantial body of literature can be subdivided into different general groups:

- A) Epidemiologic studies concerning pain and injuries in tennis;
- B) Studies concerning specific pain, injuries and their treatments;
- C) Biomechanical investigations with the goal of obtaining more information about the load on different parts of the musculo-skeletal system.

Epidemiologic studies usually are done in form of questionnaire surveys where one tries to include a large size of samples. Biener and Caluori (1977) analyzed 144 acute tennis injuries. The results show an involvement of the upper extremities in 11.5%, the trunk in 11.5% and the legs in 76% of the cases. The main causes for the injuries were abrupt starting movements (33%) and slipping on wet ground (21%). Seventeen percent (17%) of the injuries were directly related to the racket.

Kraemer and Schmitz-Beuting (1979) investigated long-term pain in tennis on a sample of 126 players. The distribution of pain was in 48% of the samples the upper extremities, in 31% the lower extremities, and

in 17% the trunk. The most frequent type of long-term pain was lateral epicondylitis (tennis elbow, 39%) and pain in the achilles tendon and the calf muscles (15%). A direct connection between the construction of the racket and occurrence of epicondylitis was found. The type of playing surface could not be related to the frequency or type of pain.

Probably the most extensive survey was done by Nigg and Denoth (1980) who created a data base of more than 2000 cases. The survey included data collected from three different playing seasons (summer/winter/summer). The results show that impairments occur in almost every part of the musculo-skeletal system. In 52.6% of the cases analyzed, pain was reported as a result of playing tennis. In 25% of the cases with pain players reported multiple pain sites, for instance, in the lower extremities as well as in the back or the arm. Furthermore, the results showed that impairment occurs with the greatest frequency in the lower extremities (41.5% of all cases of pain). It was also found that the frequency of pain is related to the type of playing surface. Four percent of the players who became impaired and were playing on sand or clay indicated that this type of surface was the cause for the pain. On the other hand, about 15% of the players who experienced pain and were playing on hard floor coverings related the occurrence of the pain to the type of surface.

Lateral humeral epicondylitis is the type of specific pain which is described and analyzed most in literature. An analysis of literature published between 1974 and 1981 shows that pain in the upper extremities (wrist, elbow and shoulder) is the subject of about 77% of the publications reviewed (Nirschl, 1974, 1981; Gruchow and Pelletier, 1979; Gunn, 1980; Priest et al., 1980). Far less literature (17%) deals with impairments in the lower extremities. Figure 1 shows the discrepancy between the frequency of pain in different locations and the number of publications related to specific pain and injuries. This apparent neglect of the lower limbs may have resulted from either methodological problems in analyzing tennis movements and loads, or a

lack of understanding of the external effects that both shoe and surface can have on the loading of the lower extremities. Recent studies of these boundary conditions in different sport areas together with statistical evidence regarding lower limb injuries strongly suggest that the analysis of these factors in tennis is a very relevant area for investigation. Hess and Hort (1973), Prokop (1976), and Segesser (1978) assumed that sport activities on synthetic surfaces can create specific problems in the lower extremities (e.g., tibial insertions tendinouses, achillodynia). Nigg and Denoth (1980) found significant differences with respect to the frequency of pain, when comparing players who played on synthetic and concrete floor coverings with those who played on sand or clay surfaces.

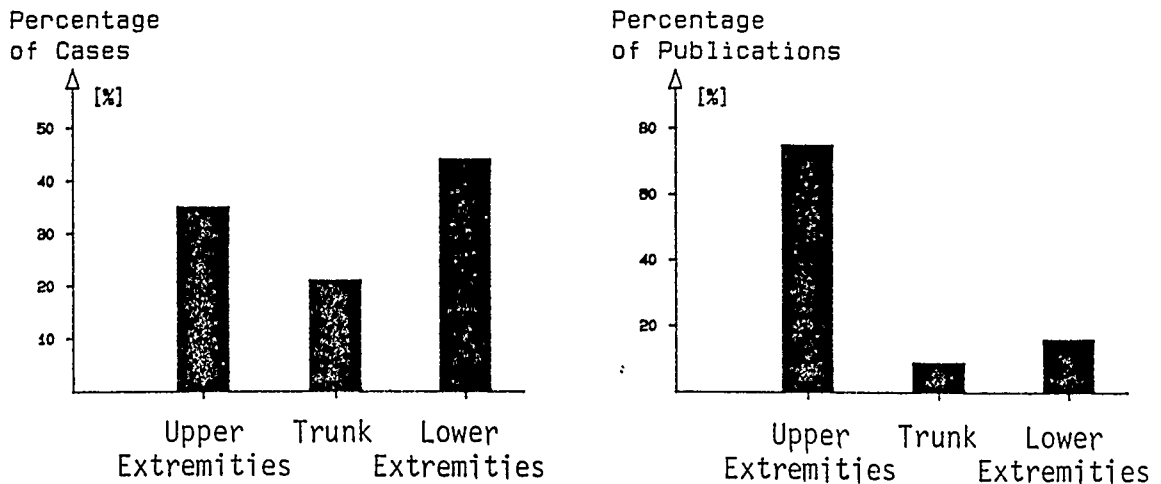

Figure 1: Relative frequency of pain and injuries in tennis (Nigg and Denoth, 1980) and relative frequency of publications related to specific pain and injuries

The influence of the sport shoe on the loading of the lower extremities has been reported by a number of authors. The absorption of impact forces in running has been described by Nigg and Denoth (1980), Nigg and Luethi (1980), Cavanagh and LaFortune (1980), Frederick et al. (1981) and Clarke et al. (1983). Nigg et al. (1978, 1981) and Bates et al. (1978, 1979) reported the influence of rearfoot control in different jogging shoes on the occurrence of pain in running. Increased lateral instability of the foot during ground contact was found for those runners who experienced achilles tendon pain, tendonitis at the tibia and weaknesses in the collateral ligaments of the ankle.

The interaction of shoe and surface was investigated by Bonstingl et al. (1975), who measured the torques developed by various shoe-surface combinations. The study was predicated upon the assumption that many knee injuries are torque related. Michel (1978) measured the maximal free moment of rotation exerted on a force platform when a test subject stepped onto the platform and performed a 180 degree turn. The measurements were done with twelve test subjects, eight different types of shoes and thirty different types of playing surfaces. The results showed differences of up to 30% for the average maximum moments for the various shoe-surface combinations. Richoz (1977) investigated the influence on two different playing surfaces (clay and concrete) on the dynamic behaviour of tennis players. He measured sliding distances of the foot of up to 1.7 m on clay but less than 5 cm on concrete.

Summary

- The number of publications dealing with load on the human musculo-skeletal system and the occurrence of pain and injury in tennis has increased greatly during the past ten years and is probably due to the increasing popularity of the game as well as the increasing frequency of pain and injuries experienced by the players.

- Epidemiologic studies show that the lower extremities, the lower back and the elbow are those parts of the musculo-skeletal system in which pain and injuries most often occur.
- Epicondylitis lateralis humeri (tennis elbow) is the type of pain which is most often described in the literature.
- Publications dealing with the physical impairment of the lower extremities only account for about 17% of the literature reviewed.
- The influence of the shoe and the playing surface on the load of the musculo-skeletal system has been frequently reported for running but not for tennis.
- Relatively little is known concerning the etiology of discomfort, pain or injury in the lower extremities of the body while playing tennis.

2.2. Basic considerations

2.2.1. Factors influencing load

Pain, discomfort and/or injury are the result of excessive stresses acting on a certain element of the musculo-skeletal system. It can result in either acute or chronic pain as a result of single or multiple overloading of one element of the musculo-skeletal system. The critical and relevant variable therefore is load. An understanding of the etiology of pain is therefore based upon the knowledge of the factors influencing load on the human body. A schematic description of these factors, illustrated in figure 2, identifies and shows the interrelationship between major variables of importance (Nigg et al., 1983). Load on the musculo-skeletal system or partial load on one

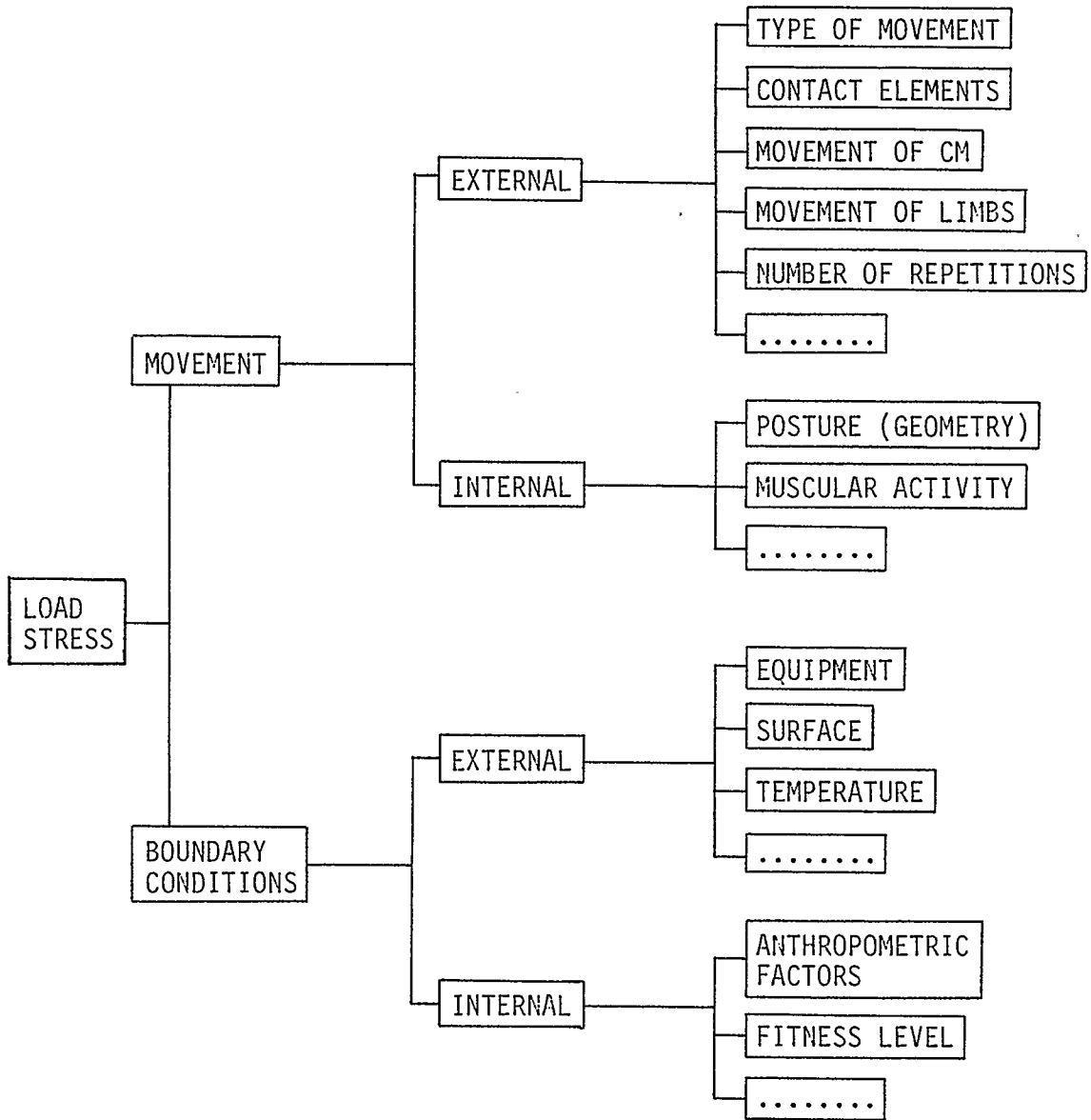

Figure 2. Schematic illustration of factors influencing load on the musculo-skeletal system (Nigg et al., 1983).

element of this system can only be described if the movement and the boundary conditions are known. The movement can be described as a result of knowledge of the external factors which impinge upon the type of movement (e.g. walking, running), the element of contact (e.g., heel, toe), the gross movement described by the displacement of the centre of mass (CM), the relative movement of each limb, the number of repetitions, etc. Movement has a second aspect that may be described as internal factors, for example, posture or geometry of movement (e.g., relative position of the leg versus foot at a given time point), the activity of each muscle, etc. In addition to these factors describing movement it is important to know the boundary conditions. In the same way that movement can be subdivided the boundary conditions may also be subdivided into external such as equipment (e.g., racket, shoe), surface on which the game is played (e.g., clay, concrete, synthetic court), temperature, etc., and internal conditions including anthropometric (e.g., length, weight, angles, age) and physiological data.

The two main fields (dynamic factors and boundary conditions) are interconnected. For example, the placement of the foot on clay as opposed to a hard surface (e.g., synthetic, concrete) is totally different. On clay courts, which may be generally classified as low friction courts, sliding is possible after foot contact. Thus, the tennis player places the foot on the ground in a way which will allow him to slide. On a surface such as concrete, asphalt or synthetic tracks, the athlete places the foot anticipating that he or she will not slide. This has an influence on the body position at the instance of ball contact, the placement of the foot on contact (heel/flat/toe) and many other variables. It is evident that the forces acting on the lower extremities will vary as specific boundary conditions (shoes, surfaces, rackets) change and interact. A study of the etiology of pain in tennis will therefore have to quantify these illustrated factors (the movement and the boundary conditions). The movement and the resulting load can be analysed using biomechanical techniques such

as film and force platform analysis. The boundary conditions can be partially influenced by the design of the study (e.g., shoe, surface, fitness level) or can be quantified by additional measurements (e.g., anthropometry). The principal sources of information (and data collection) utilized in this study are biomechanical methods and questionnaires.

2.2.2. How to determine the etiology of pain and how to assess pain

A major problem in studying the etiology of pain is to define a test population. This may be done either on a post factum basis (retrospective study) or on a prae factum basis (prospective study).

Post factum means that the population would be identified after the occurrence of pain which means in this example: one studies subjects with pain, discomfort and/or injuries (probably) due to tennis. A pain group identified would subsequently be compared to a control group without pain although because of the post factum nature of the study it would be difficult to structure a control group with comparable variables. This type of study is most commonly used and published in the biomechanics literature (Hess and Hort, 1973; Prokop, 1976; Segesser, 1976; Nigg et al., 1978). The approach prae factum means that information is collected prior to the activity (tennis) from "healthy" subjects (subjects without pain). Some of the subjects will sustain pain over a period of time and subsequently with and without pain groups can be structured with information in the same variables for both groups available for analysis.

Using the post factum approach one can never ascertain whether a difference for a given variable (which differs for pain and no pain) is the cause or the result of pain. For example, it is possible that a subject has a high value for pronation (eversion) because of pain or that pain is experienced because of the high pronation values. The question concerning the etiology of pain can therefore only be answered

in a speculative way. Using the second approach this complication is reduced and one is theoretically able to discriminate some of the factors causing pain in tennis. The previous study that identified 52% of subjects with pain suggests that the probability of becoming "injured" is relatively high and supports a prae factum approach for this study. It is anticipated that an adequate amount of information can be collected in a relatively short time. On the other hand the limitation for such a short term project is that mostly acute problems will arise and chronic pain will only have a minor influence on the results. In reality, however, an understanding of both acute and chronic pain is equally important.

A second problem is how to assess discomfort and pain and how to provide consistency in the diagnosis.

It is evident that, at the present time, discomfort or pain cannot be quantified in terms of numbers. The researcher is usually left to the subjective reports of the test subjects. In medical research the severity of pain and/or injuries is often related to substitutional variables, e.g., the time of absence from work or sports activities, the amount of money an insurance company has to pay, and so on (Biener, 1967; Kraus and Burg, 1970; Ekstrand and Gillquist, 1983). However, using this method the subjectivity cannot be excluded since, for instance, player A returns earlier to his sport than player B, both having the same problem.

A second method is to use discomfort and pain as an "on-off" switch. This means that the test subjects have the possibility to report discomfort and/or pain either as a "yes" or a "no". Therefore all subjects belong either to the one or the other category (with pain—without pain). It is obvious that the level which turns the switch on is different between subjects as well as it varies within subjects (e.g., from a day to day basis). The principle is illustrated in Figure 3.

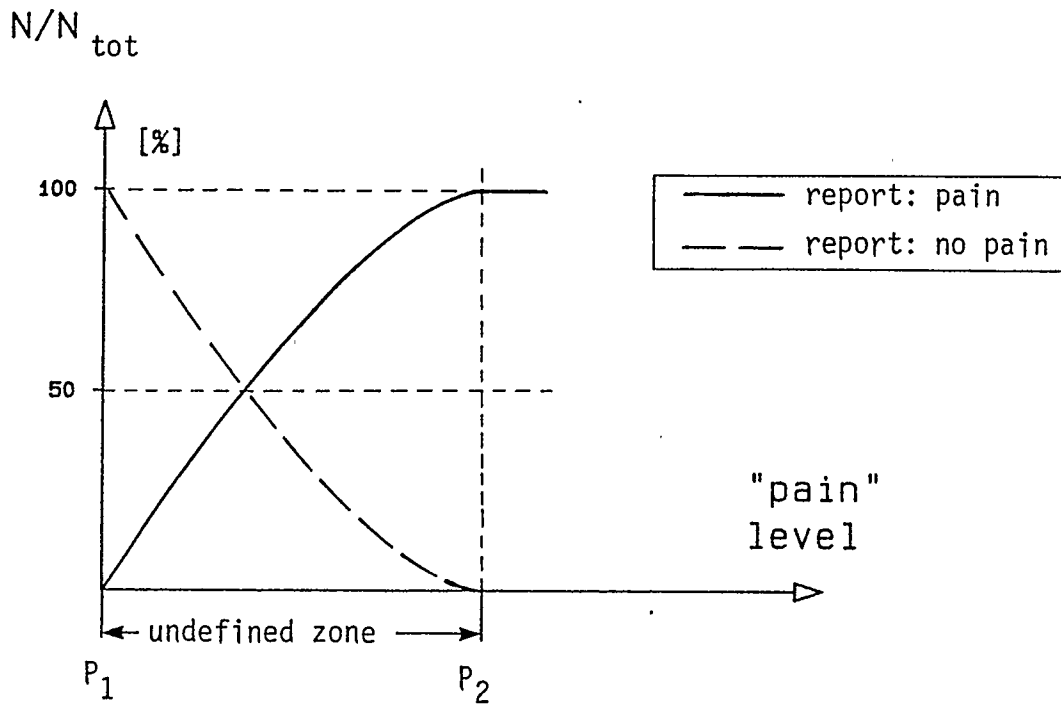

Figure 3: Schematic representation of pain reports by test subjects

At "pain level" zero (P_1), 100% of the test subjects will report: no pain. As the level increases, less test subjects will report no pain, but more subjects will report: pain. This means that the group with pain increases as the group without pain decreases. The two curves have to be symmetrical to the 50% line since the sum of both groups has to be always 100%. Eventually the "ultimate pain level" P_2 is reached where 100% of the test subjects report pain. The zone between P_1 and P_2 is undefined. This means neither is it possible to define P_2 nor is the interval known between P_1 and P_2 . However, the width of this interval can be partially influenced by the researcher by advising the test subjects what types of discomfort and pain they have to report. If the test subjects are instructed to report even minor discomfort (e.g., blisters) then the "ultimate pain

level" is set very low and the undefined zone is kept very small. Using this method, it is to expect that the majority of the test subjects will report discomfort and/or pain whenever they have a problem.

However, one has to be aware of the limitations of this method, which are:

1. No attempt is made to quantify discomfort and pain.
2. The undefined zone, even if it is kept small, still exists and therefore is an error source in the assessment of discomfort and pain.
3. The problem of relevancy arises for some minor types of pain (e.g., blisters, corns, calluses).

Keeping the limitations of this method in mind then it seems obvious that one cannot expect to get a very detailed information about the types and severities of the problems. The terms "discomfort" and "pain" are only used as general indicators about occurring impairments. However, if a physician can do the assessment immediately after a problem occurs then he should be able to diagnose the general site of pain and the type of the problem. The consistency of the diagnoses can be provided if they are filled out in codes in terms of a medical questionnaire.

3. METHOD

3.1. Symbols used

Table 1. Symbols and explanation

SYMBOL	EXPLANATION
<p>N n M m pain</p>	<p>total sample of subjects subsample of subjects for a group total sample of feet subsample of feet for a group pain, discomfort and/or injuries are represented by the expression pain. If not, specific comments are made.</p>
<p>BW F_z F_{z1} f_I t_{z1} G_{zmax} t_{zG} F_y F_{y1} t_{y1} G_{ymax} F_x F_{x1} t_{x1}</p>	<p>body weight vertical ground reaction force (measured with a Kistler force platform) first impact force peak (vertical) frequency of the vertical impact peak time of occurrence of first impact force peak maximal loading rate (slope) of the vertical force ($\text{grad } F_z$)_{max} time of occurrence of the maximal slope (vertical) a-p force first impact force peak (a-p) time of occurrence of first impact force peak (a-p) maximal loading rate of the a-p force ($\text{grad } F_y$)_{max} medio-lateral force first impact force peak (medio-lateral) time of occurrence of first impact force peak (lateral)</p>

$G_{x\max}$	maximal loading rate of the lateral force ($\text{grad } F_x)_{\max}$
I_x	lateral impulse $\int_0^T F_x dt$
α	angle of the lower leg: angle between tibia and horizontal line measured at the medial side.
α_{-10}	touch-down angle of the lower leg (last frame without contact)
β	achilles tendon angle: angle between the tibia and the calcaneus measured at the medial side.
β_{-10}	touch-down angle of the achilles tendon angle
β_H	achilles tendon angle measured at first heel contact
$\Delta\beta_{10}$	change in the angle β during the first tenth of foot contact (initial pronation)
$\Delta\beta_{\text{pro}}$	total pronation of foot during contact for achilles tendon angle
$\Delta\beta_{\text{sup}}$	total supination of foot during contact for achilles tendon angle
$\Delta\beta_{\text{tot}}$	total pronation and supination of foot during contact (achilles tendon angle)
β_{end}	take-off angle measured three frames before leaving the ground
β_{max}	external angle position measured during the first 50 msec after heel strike
$\Delta\beta_{30}$	change in the angle β during the first 30 msec of contact
$\Delta\beta_{\text{max}}$	maximum change in the angle β during the first 50 msec of foot contact
γ	rear foot angle: angle between the calcaneus and the horizontal line measured at the medial side
ϵ	knee angle measured in the sagittal plane
ϵ_{-10}	knee angle last frame before contact
V_x	touch-down velocity: lateral component
V_y	touch-down velocity: a-p component
V_z	touch-down velocity: vertical component

3.2. General remarks

The present study is the biomechanical part of the joint project: ETIOLOGY OF PAIN IN TENNIS, completed at the University of Calgary in May 1983. The project was accomplished under the supervision of Dr. B.M. Nigg. The co-investigators were Dr. M. Hawes (anthropometry), J. Bullard, M.D. (medical assessments) and S. Luethi (biomechanics). The project was realized in cooperation with the NIKE sportshoe company represented by its director of research, Dr. E.C. Frederick.

The factors influencing load on the musculo-skeletal system, which are illustrated in figure 2, can be subgrouped. The movement can be described and studied with biomechanical methods. The external boundary conditions can be assessed by using measurements of material - properties and measurements of external variables (e.g., temperature). The general plan of this study was to control as many of these factors as possible.

In the following chapters the methodology and results for the biomechanical part of the project will be outlined. However, references to the other parts of the project will be made when necessary.

3.3. Design of the study

- Step 1. A group of healthy tennis players was assessed at the beginning of the study in terms of their movement patterns (biomechanics). In addition shoe and surface variables (material tests) were measured.
- Step 2. The group of tennis players then played tennis over a defined period of time and reported on external variables such as temperature, weather, duration of game and type of game (variables).

Step 3. During this time, some players suffered pain while others remained free of injury. The subjects suffering pain underwent medical assessment.

With this study design, illustrated in figure 4, it was anticipated that an insight into the etiology of pain would emerge with reference to the initially collected data, including their movement behaviour and controlled information concerning the external variables.

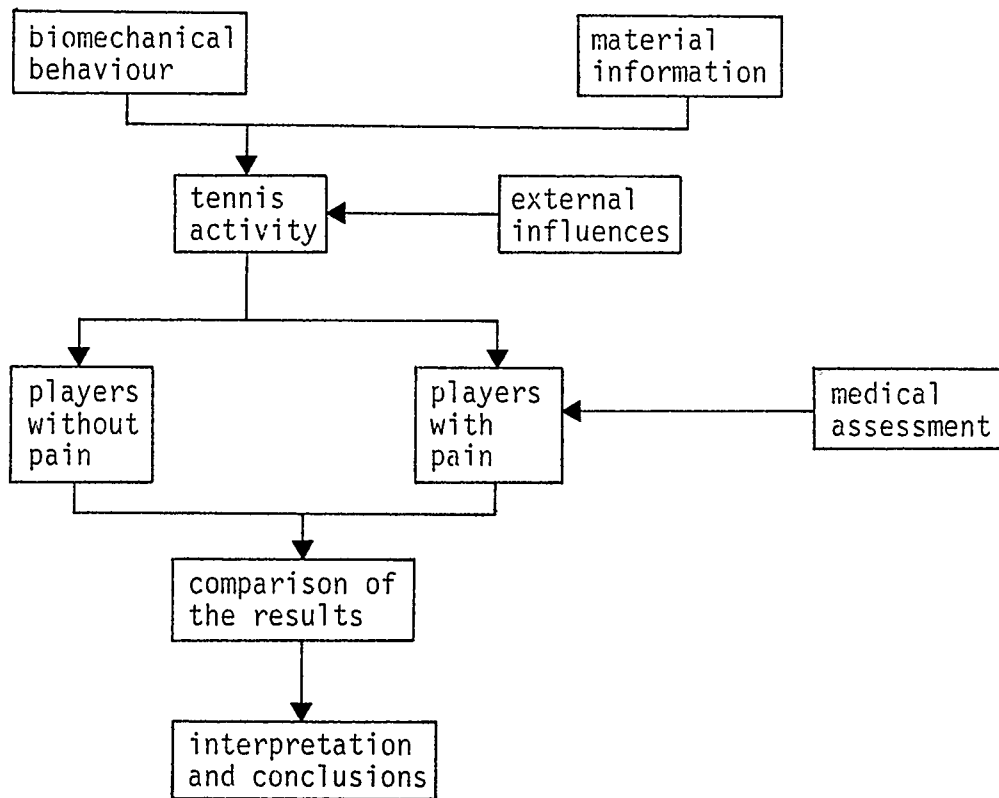

Figure 4. General design of the study

3.4. Specific information

3.4.1. Test subjects

229 subjects were recruited for the study. They were members of tennis clubs and tennis players from the university. In order to be accepted for the study the subject had to meet the following inclusion criteria:

Inclusion criteria for selection of subjects

1. The subjects had to be free from pain and injuries at the beginning of the test period.
2. The subjects had to agree to play tennis at least twice a week for a minimum period of two months.
3. The subjects had to agree to wear, exclusively, a pair of tennis shoes which were given to them at the beginning of the test period and not to wear these shoes for any other activities.
4. The subjects had to agree not to do any other major sport activity during the test period. Occasional sport activities were permitted (maximal one per week) but had to be reported.
5. The subjects had to agree to make an appointment with the physician (Dr. J. Bullard) at the medical center of the University if they suffered any discomfort, pain or injury during the test period.
6. The subjects had to agree to undergo the biomechanical and anthropometrical assessment at the beginning of the study. They also had to agree to fill out a game questionnaire after every game.

If subjects were willing to fulfill these conditions and were free of pain, they were eligible for inclusion in the study. However, some exclusion criteria were used to decide whether a subject was to stay in the study after participating partially or fully in the procedures.

Exclusion criteria after the test period

1. The results of a subject were excluded from the study if a minimum of 15 playing sessions had not been completed. However, if a subject stopped play due to pain or an injury the results were accepted for the study. (It was accepted that a subject could not finish the test period due to an injury.)
2. The results of a subject were excluded if the daily questionnaire was not filled out properly or not returned.
3. The results of a subject were excluded if the results of the game and the medical questionnaire were not consistent. (Example: the game questionnaire reported pain, but there was no medical questionnaire.)
4. The data of subjects were excluded from the study if they did not visit the physician when they suffered pain.
5. The data of subjects were excluded if they reported major sports activities other than tennis during the test period.

Using these inclusion and exclusion criteria one feels comfortable that major error sources are reduced to a minimal effect. It is obvious that such an experiment can never be totally controlled. However, with this set up disturbing side effects should be minimized.

3.4.2. Organizational procedure for test subjects

A test subject received information about the study from an informative letter or from word-of-mouth publicity. Persons identified as potential test subjects normally underwent the following procedure: The subject had a first contact with one of the laboratory members responsible for information. They received detailed information about the study, conditions and procedures. The purpose of the study was explained as an attempt to increase the knowledge of tennis. No special emphasis was given to the load or medical aspect. If the subject was still interested in participating, the general question-

naire was completed (see 3.4.4.) by a member of the laboratory. A pair of test shoes (see 3.4.3.) was then given to the test subject. The type of shoe was randomly selected. This was followed by the biomechanical assessment. The subject was also instructed how to complete the daily questionnaire.

After this initial assessment, the test subject was required to play tennis for the specified period of time. At the end of the period, the subject returned the booklet with the game questionnaires and the used tennis shoes and received a pair of new tennis shoes as a reward if everything was satisfactorily completed (i.e., their results could be used in the study).

3.4.3. Test shoes

Two models of tennis shoes were used during the study. The initial selection was theoretically based on the following criteria:

- A) The two shoes should differ in the functional behaviour of the sole (one type with "high" friction, the other type with "low" friction).
- B) The two shoes should not differ in the rest of the construction in order to avoid multiple influences.

The easiest way to reach these goals would have been to construct one type of shoe with different sole materials. This procedure was too expensive. The procedure chosen for the selection is described as follows:

Six different types of shoes were tested subjectively by two intermediate level tennis players. The subjective testing was completed by wearing each type of shoe. Secondly, material tests (friction) were completed with these six types of shoes. In addition, film and force measurements were made with two subjects (as described in 3.4.5) in order to determine possible differences in biomechanical variables due

to the shoe. These three assessments and their results are described in the next three subchapters.

a) friction measurements (completed in the Nike laboratory)

Both translational and rotational friction measurements were made (Nike Laboratory, Clarke et al., 1982, int. report). The results of the static friction coefficients for translation are illustrated in figure 5. The results were obtained by loading the shoe with an additional mass of 12 kg and then applying a fore/aft shear force. The measurements were therefore based on the theoretical assumption that Coulomb friction can be applied.

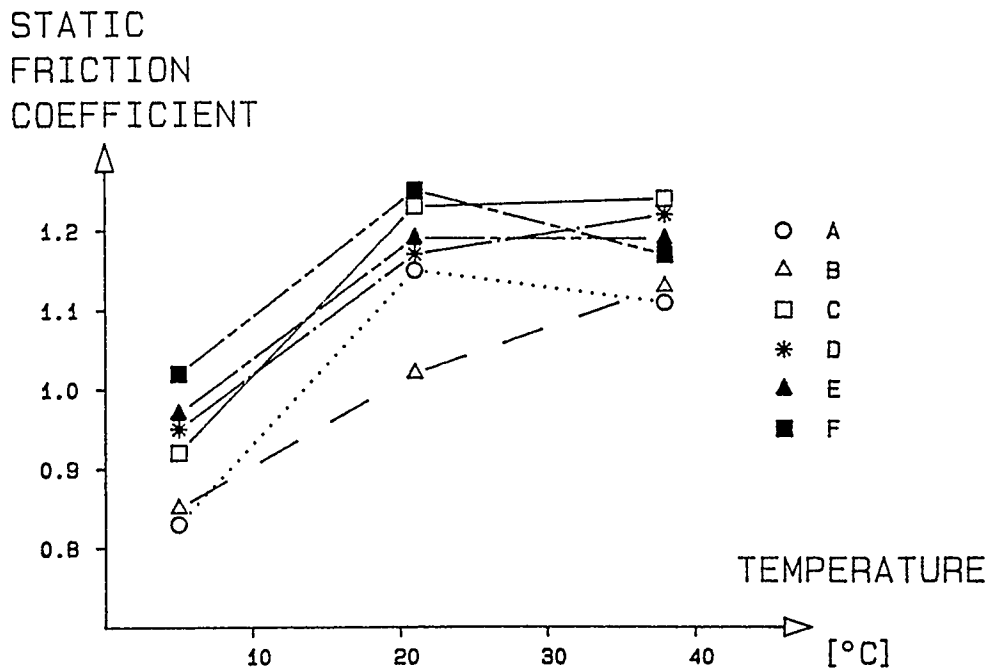

Figure 5. Results of the static friction coefficients for the six different shoe types for three different temperatures. (Clarke et al., 1982, int. report)

For the friction coefficient μ , which is independent of the load, the velocity (for dynamic coefficient) and the contact area, one can use the formula

$$\mu = \frac{F_h}{F_z}$$

where F_z = vertical force
 F_h = horizontal force
 μ = friction coefficient

The two forces were measured with the Kistler force platform. The surface used was a pressed rubber material (cal-trac).

Based on these results the following conclusions were made:

- the two shoes which show a non monotonic temperature dependency, shoe A and F, cannot be used. The turning point is not known and the non monotonic behaviour may be a source of unexpected and uncontrolled influences.
- shoe B of the remaining group shows the lowest friction coefficient and is clearly different to shoes C, D and E whose friction coefficient are relatively close together. Shoe B therefore was included in the study as the "low" friction shoe.

The rotational frictional behaviour measurement was performed with the Kistler force platform. The variable measured was the maximal free moment of rotation as a subject stepped onto the test surface and executed a 180 degree turn. It is obvious that from a theoretical point of view not only the friction coefficient but also the area of contact and the applied load have an influence on the value of this free moment of rotation. However, the results (measured only for room temperature), illustrated in figure 6, support the findings of the translational tests. Shoe B has the lowest value and shoes C, D and E have similar values.

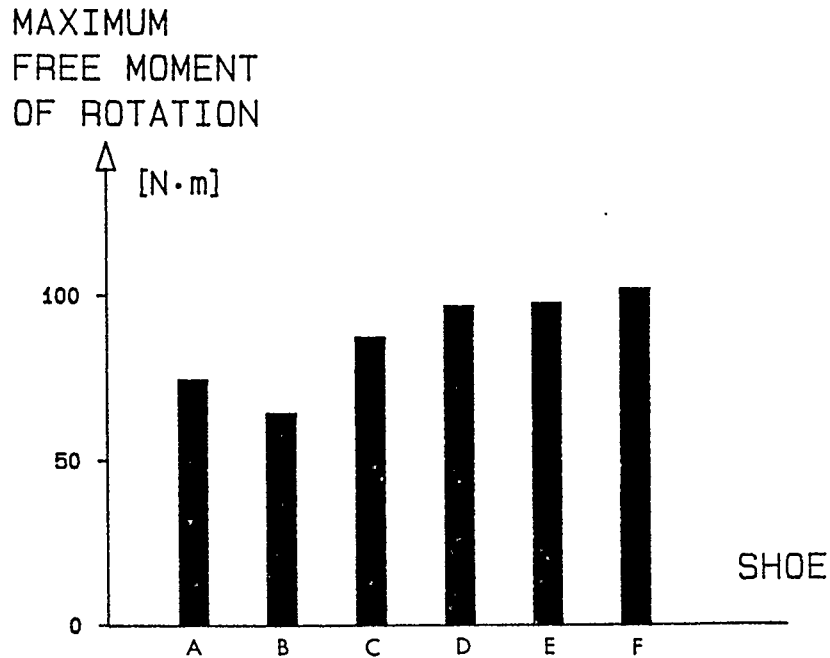

Figure 6. Maximum free moment of rotation results for one step and 180 degrees turn (Clarke et al., 1982, int. report)

b) Film and force measurements

Film analysis and force measurements were performed with two subjects (4 feet). The test movement was running (heel-toe contact). The methodology used was the same described later for the biomechanical test procedure (3.4.5.) and is also reported elsewhere (Nigg and Luethi, 1980). The analysis (only reported for the remaining shoes B, C, D and E) showed the results summarized in table 2. Based on these results, shoe E appears to be the one with the worst results in comparison to shoe B which was already included in the study.

Shoes C and D show little difference in the selected kinematic and kinetic parameters.

Table 2 Summary table of the pilot measurements with film and force platform for the shoe selection ($m = 4$ for each shoe).

VARIABLE	UNIT	SHOE B	SHOE C	SHOE D	SHOE E
F_{z1}	[N]	1050	1065	1080	1135
F_{zmax}	[N]	1802	1891	1895	1943
β_0	[°]	172.4	173.8	171.1	171.0
β_{end}	[°]	167.3	171.4	172.4	167.5
$\Delta\beta_{10}$	[°]	5.7	9.8	10.7	11.7
$\Delta\beta_{pro}$	[°]	14.3	13.5	14.6	15.7
$\Delta\beta_{sup}$	[°]	22.7	19.2	17.1	25.7
$\Delta\beta_{tot}$	[°]	37.0	32.7	31.7	41.5

c) Subjective assessment

Subjective assessment was done by two subjects wearing shoe C and D for test movements during a short time. The subjective assessment gave shoe C the better rating.

Based on the preceding results it was decided to use shoe B and shoe C for the study. It is obvious that the most weighted factor was frictional behaviour. Although the analysis of the kinematic and kinetic measurements showed fairly similar results it has to be pointed out that the construction characteristics differed in several aspects between the two shoes. Aspects of the shoes other than the functional behaviour may therefore influence the results and will be kept in mind during the study. Subsequently, the two shoes are described as shoe 1 and shoe 2 in the following paragraphs, where shoe 1 is the model "B" and shoe 2 is the model "C". Specific characteristics are summarized as follows:

Shoe 1 This shoe has a suitable soft polyurethane sole with a thick rubber layer at the outsole. The materials and tread characteristics lead to the low friction behaviour. The upper part, which is very flexible in the medio-lateral direction, is composed of a nylon mesh and leather. The removable insole has a medial support which is situated in the back half of the shoe.

Overall, this shoe can be described as a soft, flexible and comfortable tennis shoe.

Shoe 2 This shoe has a fairly stiff rubber sole with a characteristic (imprinted) tread. The upper part is made of canvas and the thin insole cannot be removed. There is a medial support in the shoe which is situated about in the middle of the shoe.

Overall, this shoe is harder and stiffer than shoe 1.

3.4.4. Questionnaires

As mentioned earlier, three different questionnaires were used in the study, a general questionnaire, a daily questionnaire and a medical questionnaire.

a) General questionnaire

After an initial introduction to the interested person which consisted of reading the general information (Appendix A) and an oral explanation and after ascertaining that the person fulfilled all the inclusion criteria, the general questionnaire was completed by the interviewer. This general questionnaire (Appendix B) included information such as name, address, sex, age, weight, height, skill level, time involvement in tennis, surface information, other physical activities and racket information. The questionnaire included several check questions

concerning the inclusion criteria and was additionally used to eliminate subjects which did not fulfill the inclusion conditions for the study.

b) Game questionnaire

After every playing session the test subjects had to complete a "game questionnaire" (Appendix C). It included questions concerning weather, temperature, type and length of game, surface information, information concerning the shoes (comfort, grip, perspiration, support), pain (time, site, cause) and had a section for additional comments. Some of the questions were a duplication of the information gathered in the medical questionnaire and used to check the quality and consistency of the collected information. The questionnaire was also used to exclude pain cases where the origin was not tennis.

c) Medical questionnaire

The medical questionnaire (Appendix D) was completed whenever a subject visited the physician because of pain, discomfort and/or injury. The physician filled in the questionnaire in code to provide consistency in the diagnosis. It was planned to have all the medical assessments completed immediately after a tennis session during which pain occurred. However, this was not always possible and some diagnoses were made later, if feasible from the medical point of view. The medical questionnaire included general information (name, playing session, shoe type), anatomical site, description of the type of injury, timing, final diagnosis, additional comments and treatment.

3.4.5. Biomechanical measurements

a) Test movements

A battery of 3 representative test movements was developed from which kinematics and kinetics of the test subjects were obtained. The following criteria were considered to be important for the selection of the movements:

Relevance of type and geometry of the movements for the game of tennis

In a previous study it was shown that forwards and sideways are the most frequent directions of movement in tennis. Other findings were that heel strike is a frequent type of landing and that more than 60% of the so-called "loading" movements in tennis are connected with abrupt changes in velocity and direction (e.g., running-stopping, hopping sideways with change of direction: outwards-inwards).

Repeatability of the movements

The problem of repeatability often occurs in movement analysis. Twisting and multiplanar movements are especially difficult to perform by test subjects several times within a reasonably small variation. This means if such a movement is performed more than once by a group of test subjects, the intraindividual variation (variation within subjects) can be greater than the inter-individual variation (variation among the subjects).

All test subjects had to be able to perform the movements without particular difficulties

In the present study it was intended to have a large variation within the test subject group with respect to age and playing ability. Obviously the motoric capabilities of a 60-year old recreational tennis player may differ greatly from those of a

20-year old competitive player. However, the goal was that both players would be able to perform the test movements without difficulties.

Based on the considerations mentioned above, the following three test movements were chosen for the biomechanical assessment (table 3).

Table 3. Test movements chosen for the biomechanical assessment

	DESCRIPTION	ELEMENT OF FOOT MAKING FIRST CONTACT	DIRECTION AND CHANGE OF DIRECTION
MOVEMENT 1	running	heel	forwards, no change of direction
MOVEMENT 2	running-stopping	heel	forwards, forwards - stop
MOVEMENT 3	hopping sideways	flat foot	sideways, outwards - inwards

Movement 1: The test subjects ran on a lab runway at a pace of about 3 m/sec. The step length was given (1.5 m) and the participants were told to strike the ground with the heel first.

Movement 2: The first part of this movement was the same as movement 1 but then the test subjects were instructed to stop on one foot similar to a stopping movement in tennis.

Movement 3: This movement consisted of a shuffle sideways. The test subjects were hopping sideways to a point where they stopped on the outer foot and turned back to the starting point. The participants were instructed to perform this movement in the fastest way possible.

Number of trials: The test subjects performed each movement twice so that kinematic and kinetic data could be obtained for a right and a left footfall.

b) Measuring methods and data collection

In the Introduction it was mentioned that the mechanical load which acts upon the various structures of the musculo-skeletal system during tennis activity is an important criterion in the present study. The mechanical load can be described as:

$$\text{load} = f(\vec{F}_{\text{ex}}, \vec{F}_{\text{int}}, \vec{x}, \dot{\vec{x}}, \varphi, \dot{\varphi}, \dots)$$

where:

\vec{F}_{ex} :	External forces acting on the body (ground reaction forces)
\vec{F}_{int} :	Internal forces acting in the body (e.g., joint forces, muscle forces, forces exerted by ligaments)
\vec{x}, φ :	Variables describing the geometry of the movement
$\dot{\vec{x}}, \dot{\varphi}$:	Variables describing the velocity of the movement

The kinematic variables ($\vec{x}, \dot{\vec{x}}, \varphi, \dot{\varphi}$) can be measured indirectly using high speed cinematography and the ground reaction force data can be collected on-line with suitable force platforms in connection with a computer.

In the present study the kinematic data were obtained from cine film using a Locam II high speed camera at a frame rate of 100 frames/sec for all three movements. The subjects were filmed from posterior (see fig. 8). The inclusion of a mirror, placed at 45 degrees to the direction of motion allowed a side view of the lower extremities for the movements 1 and 2. Markers were placed on the shoes and on anatomical landmarks of the lower extremities (fig. 6).

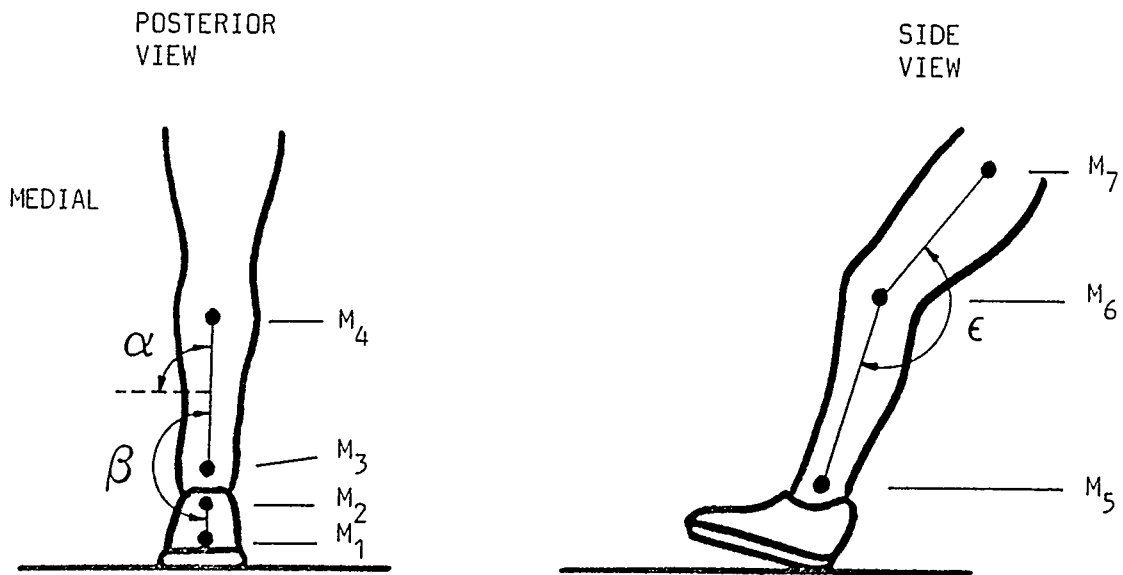

Figure 7. Location of the markers on the shoes and lower extremities and the kinematic variables measured from film.

The markers M₁ and M₂ were placed on the hindmost part of the shoes representing the lower and upper point of the calcaneus (Nigg and Luethi, 1980). M₃ and M₄ were placed similarly on the left and right leg of the test subjects while standing in an upright stance with the feet 20 cm apart. The location of M₃ was 10 cm superior of the plantar surface centered on the achilles tendon and M₄ was placed another 12 cm superior to M₃ on the longitudinal axis of the leg.

M_5 was located on the medial malleolus of the left leg and on the lateral malleolus of the right leg. M_6 was placed 3 cm posteriorly to the patella (laterally on the right leg and medially on the left leg) and M_7 was located on the uppermost point of the greater trochanter of the right femur and on the medial aspect of the left thigh.

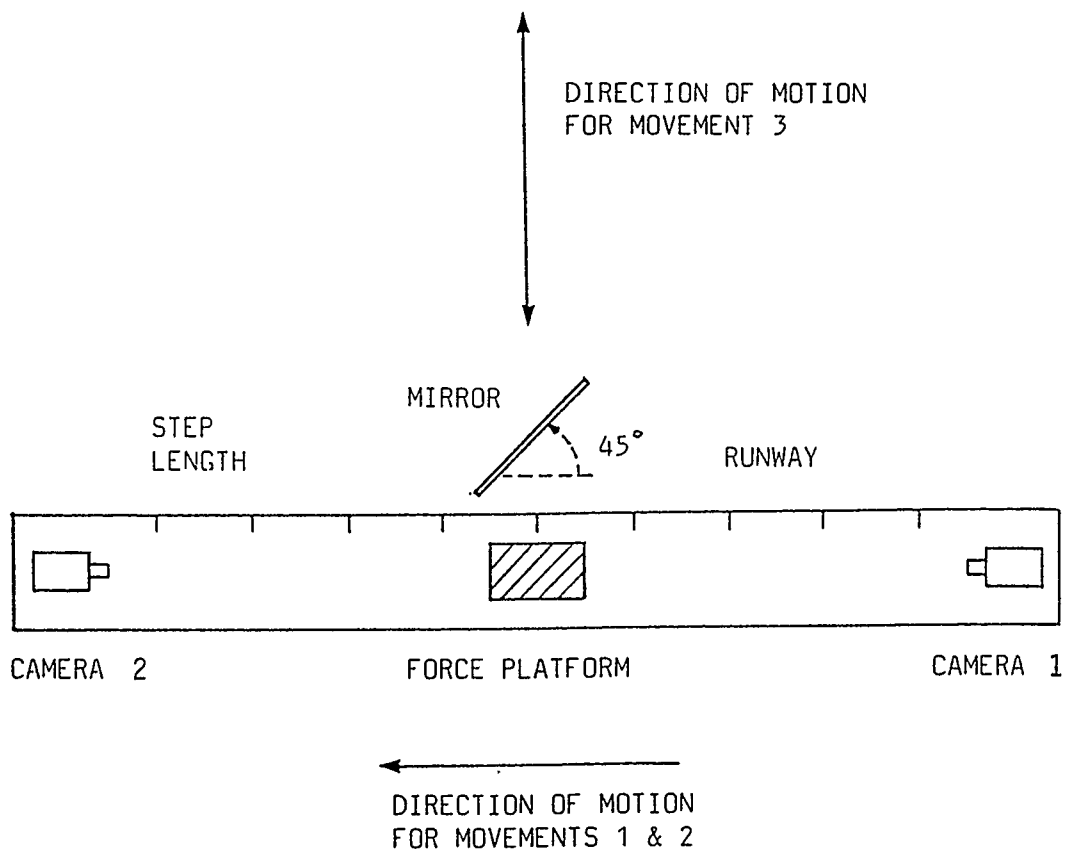

Figure 8. Set-up for the biomechanical tests. (Movements 1 and 2: All foot contacts were filmed with camera 1. Movement 3: The mirror was taken away, the left foot contacts were filmed with camera 1, the right foot contacts with camera 2).

The external forces during foot contact were measured using a Kistler force platform. The three force signals (vertical: F_z , anterior-posterior: F_y , lateral: F_x) were sampled on-line at 400 Hz using a PDP-11/23 microcomputer and stored on floppy disks for further processing. A special coding system was used in order to be able to identify each trial and to make the desired case selections in the analysis (table 4).

Table 4: Coding system used for trial identification

CODE #	DESCRIPTION
1	Subject number
2	Trial number
3	Foot (1 = left; 2 = right)
4	Type of movement (1, 2, 3)
5	Direction of movement (1 = forwards; 2 = sideways)
6	Pain (1 = yes; 2 = no)
7	Type of pain (1, 2,, 7)
8	Weight
9	Shoe number (1, 2)

The codes were entered into the computer immediately prior to the corresponding trial. The code numbers 6 and 7, "Pain" and "Type of pain" were entered for all test subjects after they had completed their long-term test period.

c) Data analysis and data control

The film data analysis was performed with a film-analyzer-system, consisting of an HP 9845B microcomputer and an HP 9874A digitizer. The

film was projected from above by an overhead Vanguard projection head (fig. 9). The x-y coordinates of the desired anatomical landmarks were digitized and stored on tapes. Existing and new developed software (Appendix E) was used to convert the raw data and to calculate the variables of interest. All single results for each trial were printed or plotted for the purpose of data control.

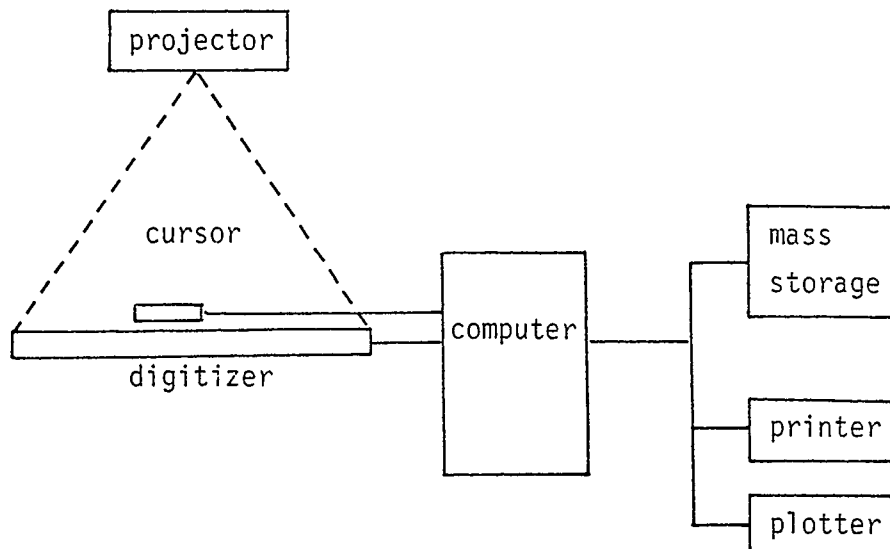

Figure 9. Data analysis from cine film measurements.

The data from the force measurements were processed and converted on the PDP 11/23 computer (fig. 10). Each single force curve was first plotted on an HP 7220C plotter and visually checked before further processing.

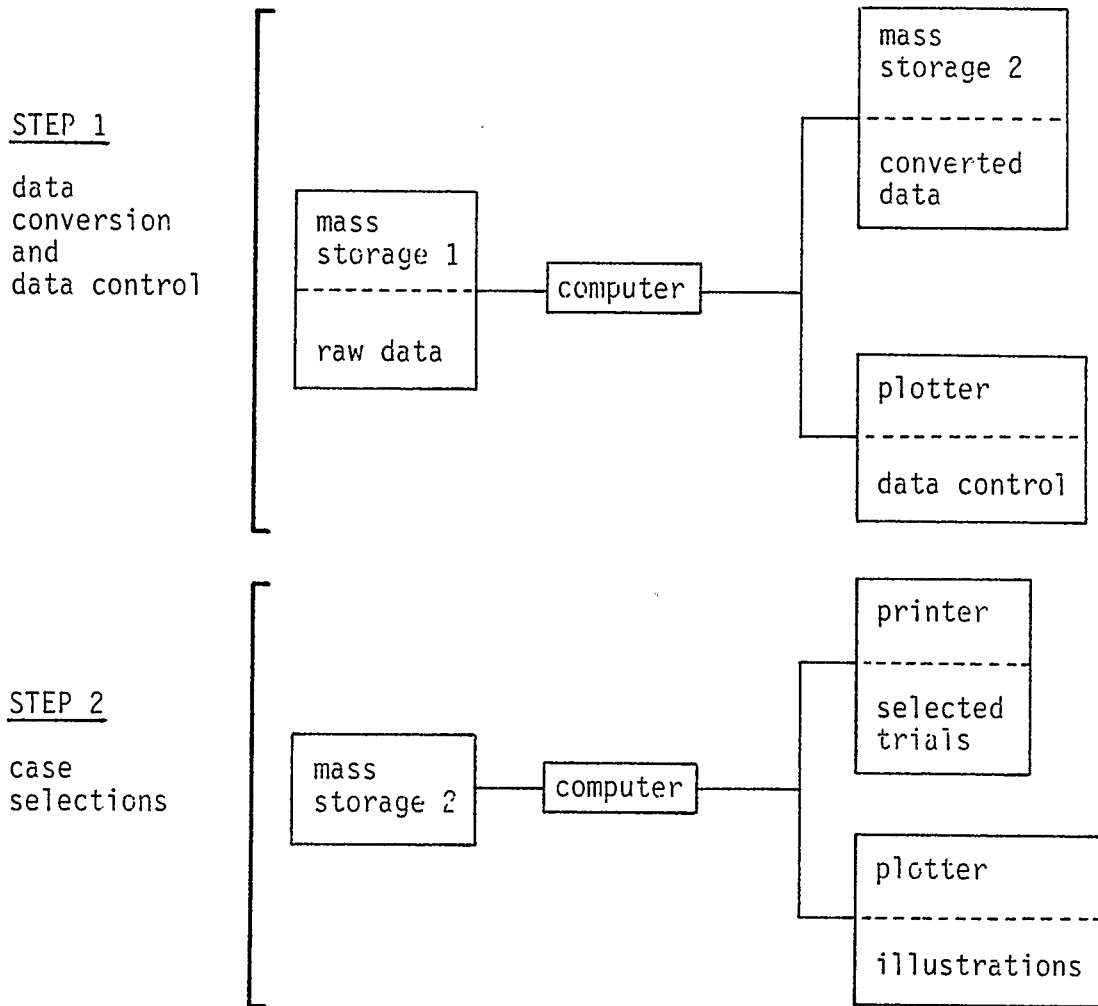

Figure 10. Flow chart for force data processing

d) Analysed Variables

Movement 1:

The set of kinematic variables analyzed for this movement includes the time history of the "achilles tendon angle" (see fig. 11) during foot contact in order to get information about lateral stability of the foot. Special variables of interest are the amount of initial pronation during the first tenth of foot contact, $\Delta\beta_{10}$, the total amount of supination, $\Delta\beta_{sup}$, and the take-off angle, β_{end} . The knee angle ϵ , measured one frame before heel strike and the calculated components of the average touch-down velocity of the heel, V_z , V_y and V_x describe the geometry, direction and velocity of the movement immediately before first ground contact.

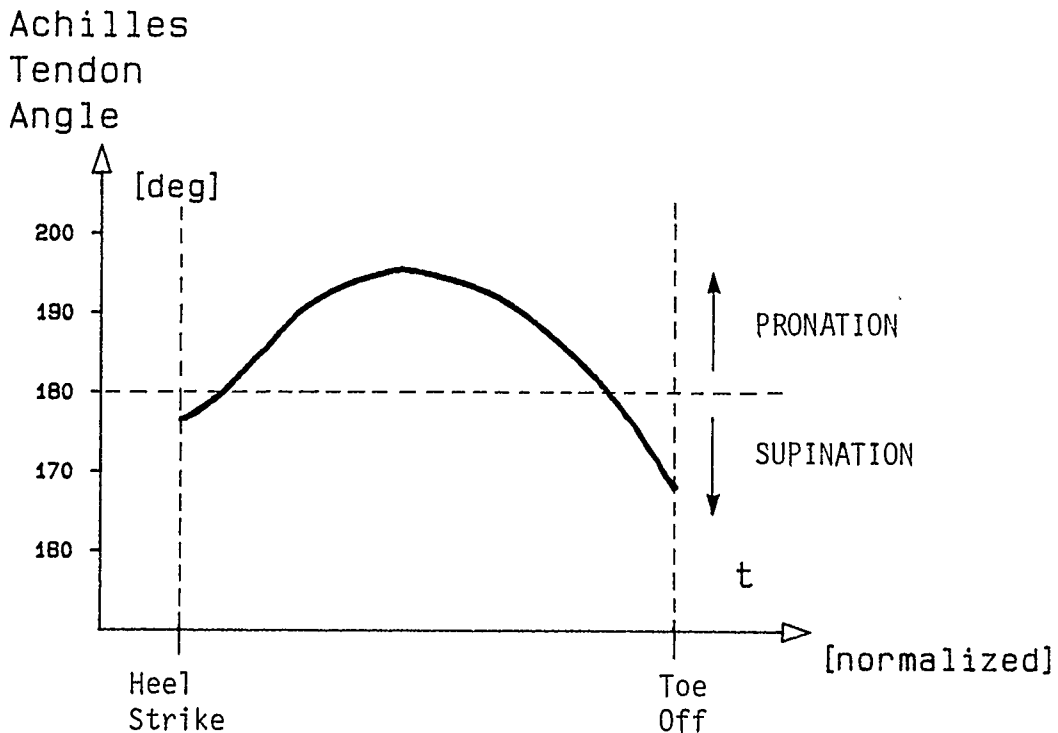

Figure 11. Example of the time history of the achilles tendon angle during one foot contact in running.

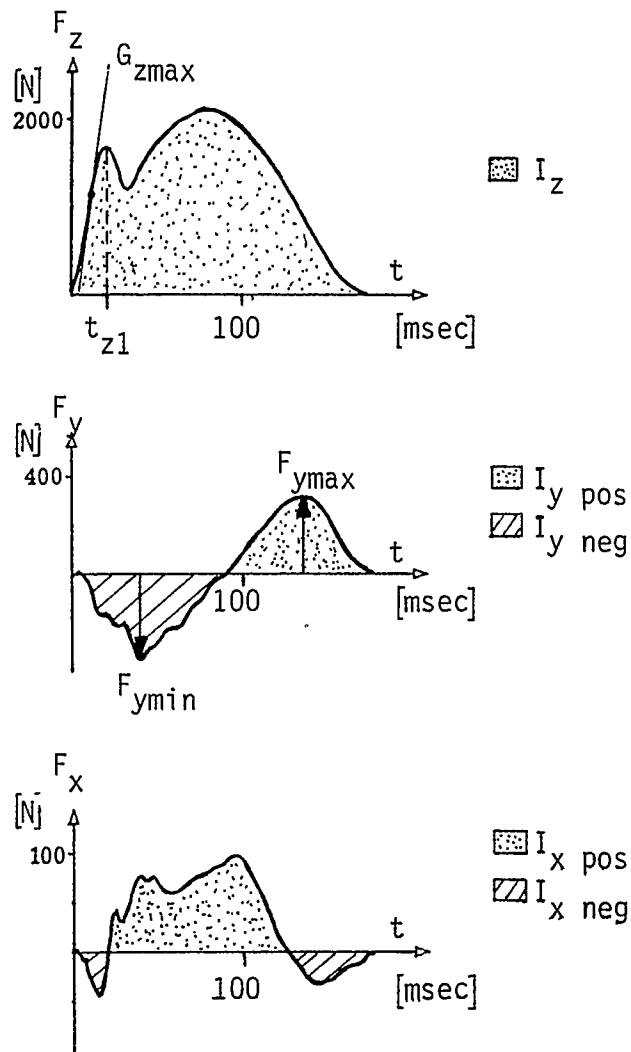

Figure 12. Schematic representation of the force-time curves and the analyzed force variables for movement 1.

The analysis of the external forces (fig. 12) includes the magnitude of the vertical impact force peak, F_{z1} and its time of occurrence, t_{z1} and the maximal rate of loading, G_{zmax} . Maxima and minima of the fore-aft and the lateral shear forces were evaluated as well as the positive, negative and absolute integrals of the curves.

Movement 2

Stopping instantaneously on one foot during running means that high impact force peaks are measured on the ground. Fig. 13 shows an example of the ground reaction forces measured during such a movement.

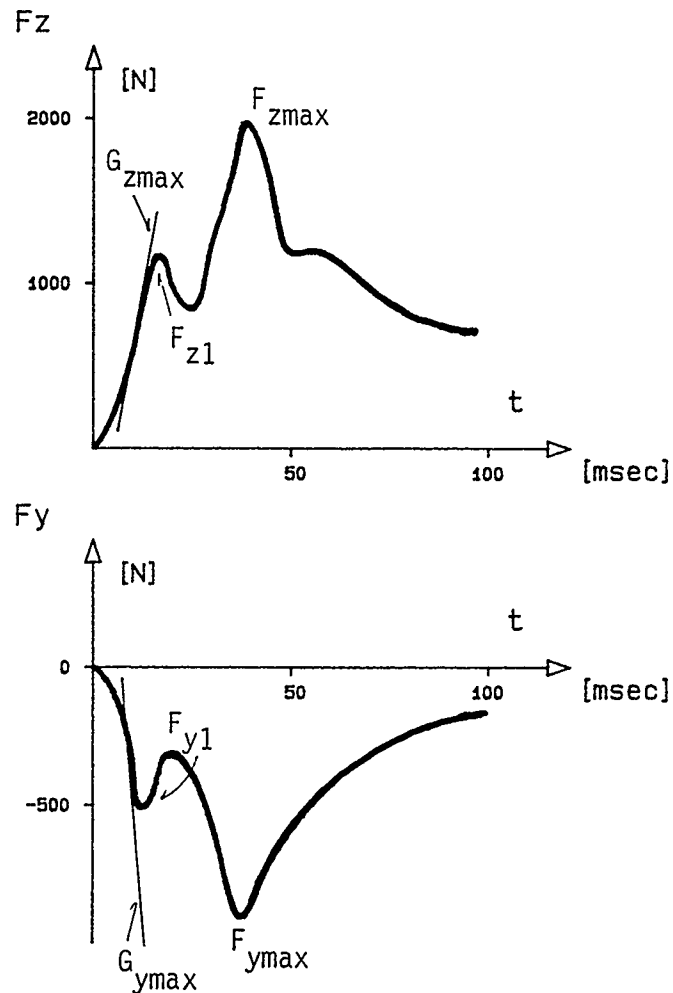

Figure 13. Representation of an example of the vertical and fore-aft force curves for movement 2 (running-stopping)

The magnitude of the impact force peaks F_{z1} and F_{y1} are included in the analysis as well as the maximal forces F_{zmax} and F_{ymax} . Additionally the time of occurrence of the impact peaks, t_{z1} and the loading rates, G_{zmax} and G_{ymax} , were evaluated.

The initial pronation during the first 30 msec of the stopping movement $\Delta\beta_{30}$ was measured from the film and the magnitude and direction of the touch-down velocity and its components were calculated. The angle was measured one frame before contact. Figure 14 shows an example of the time history of the angle β during the first 30 msec of foot contact.

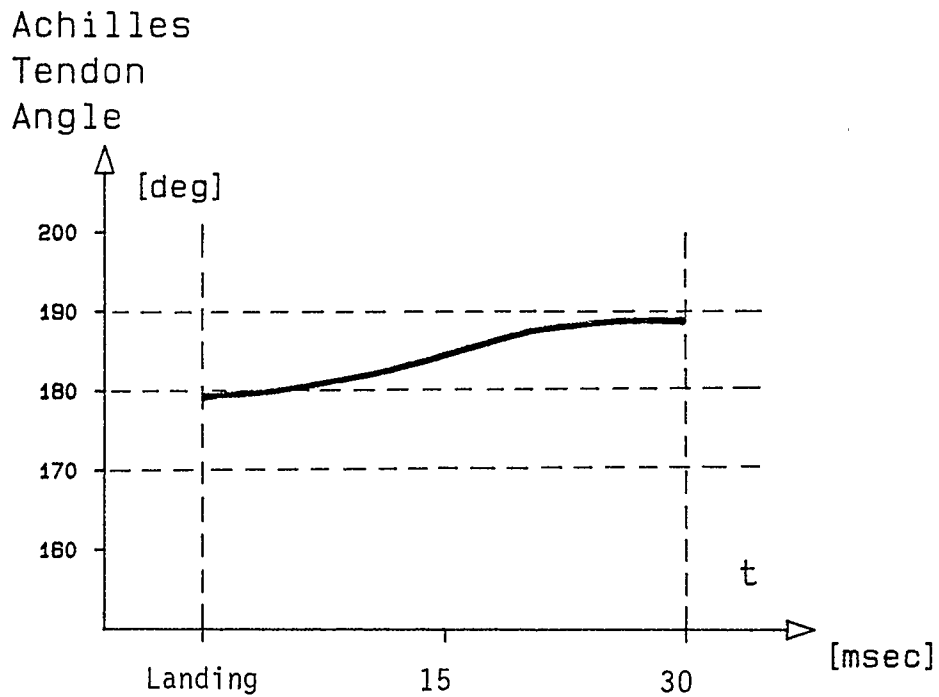

Figure 14. Representation of an example of the time history of the achilles tendon angle β during the first 30 msec of foot contact

Movement 3

The gross initial geometry of this movement was evaluated from film one frame before touch-down with the angles α_{-10} and β_{-10} (fig. 15). Direction and velocity of the foot was analyzed by measuring the

vertical and lateral components of the touch-down velocity vector of the heel. β_0 was measured at the time of first foot contact and β_H represents the first heel contact. Additionally, the maximum inversion of the foot during the first 50 msec of heel contact, β_{max} was calculated as well as the maximum change in this angle, $\Delta\beta_{max}$ within this time interval. Figure 16 represents an example of the time history of β .

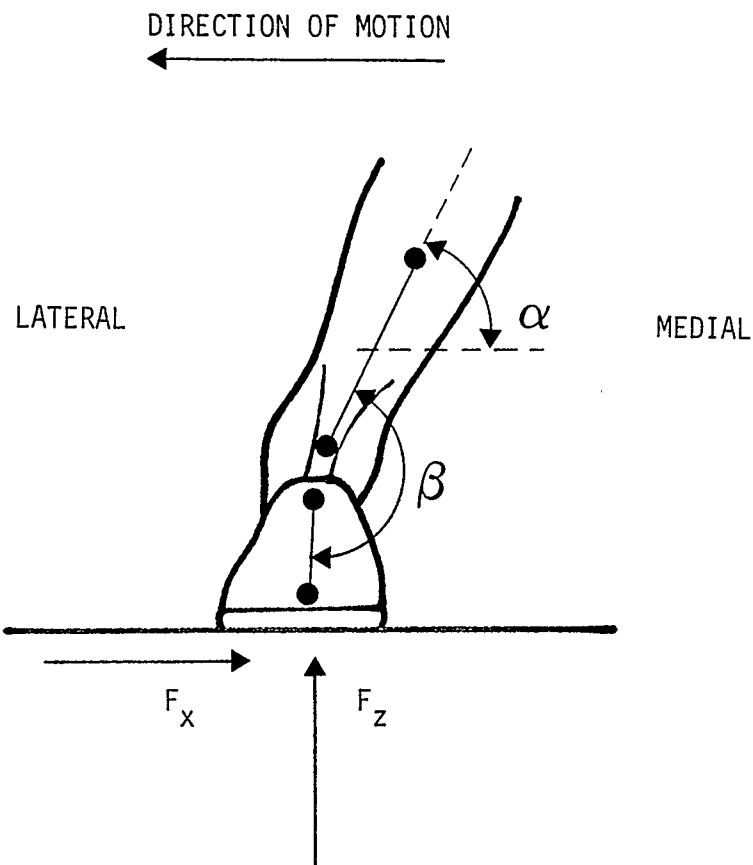

Figure 15. Representation of the kinematic variables for movement 3.

Change in
the Achilles
Tendon Angle

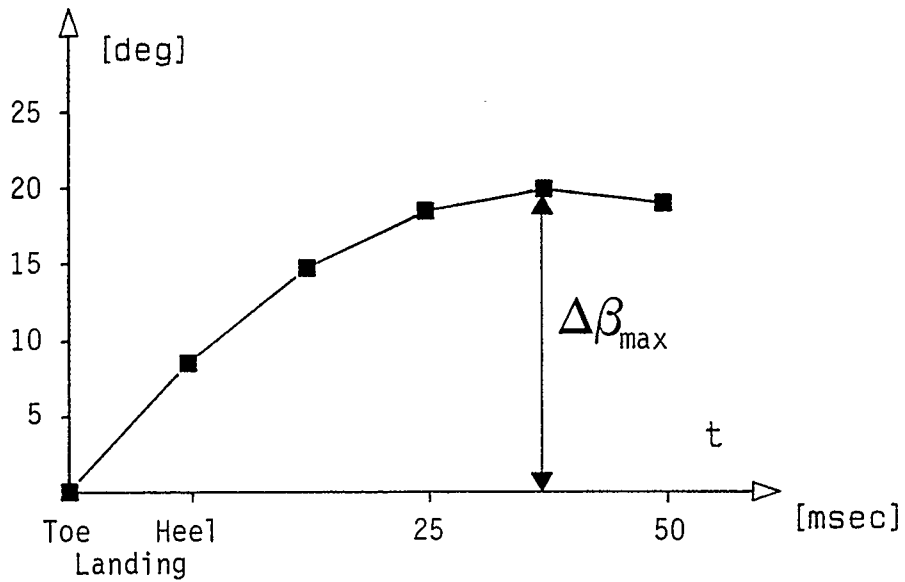

Figure 16. Time history of the angle β for one example.

The vertical and lateral maximum peak forces, $F_{z\max}$, $F_{y\max}$, their time of occurrence, $t_{z\max}$, $t_{y\max}$ and the loading rates $G_{z\max}$, $G_{y\max}$ were evaluated. Figure 17 shows an example of the two analyzed force components.

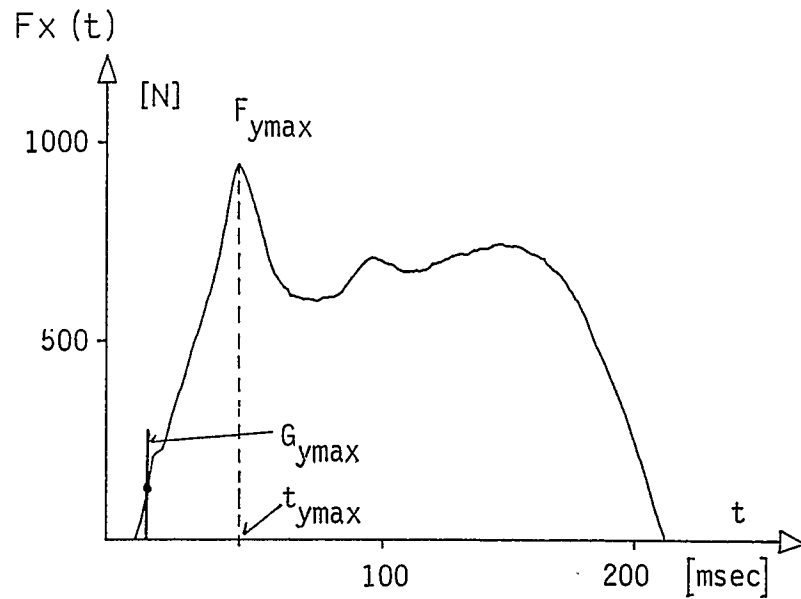
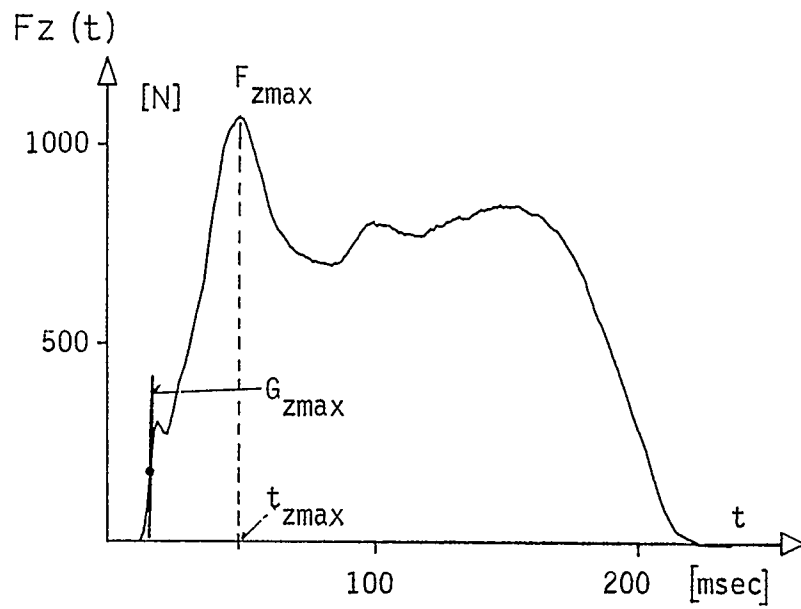

Figure 17. Representation of the vertical and lateral ground reaction forces during one foot contact for movement 3.

3.4.6. Statistical analysis

For all sets and groups of data used in the project, the means, standard deviations and standard errors were calculated. The description of the population, based on the results from the daily questionnaires, was made with a frequency analysis. The influence of the boundary conditions (e.g., type of shoe, type of surface) was evaluated using either contingency tables or cross tabulation. The level of significance set in this study was $\alpha = 0.05$.

Student's t-test was applied to test differences of the main groups, e.g., subjects with pain wearing shoe 1 vs. subjects with shoe 1 and no pain. However, no statistical tests were done for the different pain subgroups except for the groups who had forefoot pain and toe pain where the number of subjects was sufficiently large.

Pearson correlation was applied to the biomechanical variables to establish the variables which were subsequently included in the discriminant analysis. This analysis provided information concerning the variables which are able to statistically distinguish between the group with pain and the group without pain.

4. RESULTS AND DISCUSSION

4.1. General results

4.1.1. Description of the population

For the study, 229 subjects were recruited. They had their first interview, received a pair of tennis shoes at random and performed the biomechanical tests. From this initial number, 58 subjects dropped out or were excluded. The reasons for exclusion for the final analysis were:

38 did not return the game questionnaire booklet

9 reported pain but did not visit the physician

4 played less than 15 games

2 reported pain but related this pain to previous injuries

2 lost booklet

1 was active in another sport

1 shoe wore out before 15 games

1 returned booklet too late

Table 5. Summary of the population of the analysis

	n(MALE)	n(FEMALE)	n(TOTAL)
BEGINNER	11	14	25
INTERMEDIATE	74	21	95
ADVANCED	47	4	51
SHOE 1	76	10	86
SHOE 2	56	29	85
TOTAL	132	39	171

The total number therefore included in the final analysis was 171 test subjects, 132 were male, 39 female, 25 were classified as beginners, 95 as intermediate and 51 as advanced players. 86 used shoe 1 and 85 shoe 2 (see Table 5). The different skill levels are adequately distributed throughout the test population.

However, the distribution of the shoes between male and female is one sided. Three times as many female test subjects had shoe 2 than shoe 1. (This was due to the fact that shoe 1 did not have the small sizes required by the females.)

Table 6 Average, SD, maximum and minimum for age, height and body mass

VARIABLE	GROUP	UNIT	n	x	SD	x(min)	x(max)
AGE	all	yrs	171	25.9	8.8	13	66
	male	yrs	132	26.0	9.2	13	66
	female	yrs	39	25.5	7.4	15	44
	shoe 1	yrs	86	27.2	9.3	14	66
	shoe 2	yrs	85	24.6	8.0	13	57
HEIGHT	all	cm	171	174.7	6.3	151	194
	male	cm	132	176.9	7.3	151	194
	female	cm	39	167.2	7.3	151	179
	shoe 1	cm	86	176.3	7.2	160	193
	shoe 2	cm	85	173.1	9.1	151	194
MASS	all	kg	171	70.7	10.9	42	98
	male	kg	132	73.9	9.5	46	98
	female	kg	39	59.7	8.2	42	78
	shoe 1	kg	86	73.8	9.7	52	98
	shoe 2	kg	85	67.4	11.2	42	92

The distribution of the group concerning age, height and body mass is summarized in Table 6. The results in this table are a comprehensive summary of the test groups. The age information shows an average of 25.3 years for the total group ranging from 13 to 66 years. There is no difference between male and female averages. However, the average age of the shoe 1 group is 2.6 years higher than the average age of the shoe 2 group. The average height is 174.7 cm for the total group. The male test subjects are on average 9.7 cm taller than the female. There is also a difference between the height of shoe 1 group and shoe 2 group where the shoe 1 group is on average 3.2 cm taller. The average mass is 70.7 kg for the total group. The mass of the male test subjects is (in analogy to the height) 14.4 kg greater than the average mass of the females. In analogy to the results for height, the mass of the subjects with shoe 1 is 6.4 kg larger than the shoe 2 group.

The fact that the two subgroups, male and female, have different values for height and body mass is consistent with the values of the normal distribution of male and female. The differences in the two shoe groups is mainly connected with the uneven distribution of the females in these two groups. All results relative to the two shoe groups must be considered in light of this noted difference.

4.1.2. General results concerning pain

The medical questionnaire revealed that 68 out of 171 subjects reported pain (fig. 18). That such a large percentage of healthy tennis players are afflicted with pain during a period of about 2 months of tennis activity is surprising as well as alarming. Fifty out of 132 males and 18 out of 39 females reported pain and had a medical questionnaire. However, the difference between the percentage of males (37.8%) and females with pain (46.2%) is not significant. It was mentioned in the methodological part but should be reiterated that "pain" ranges between discomfort and injury. It was evident in this sample that there was a greater tendency towards discomfort than injury.

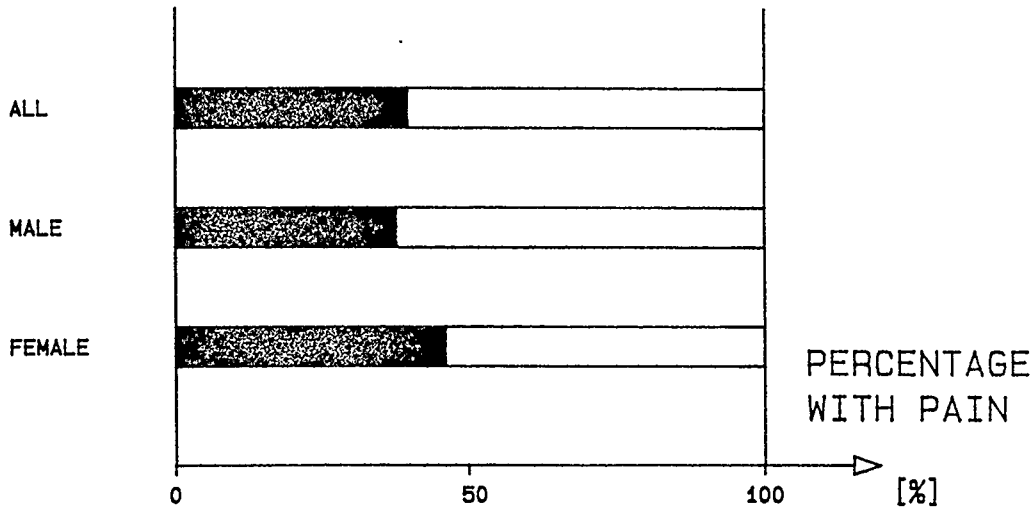

Figure 18. Summary of the percentage with pain during the study for the total group (all, N=171) and the subgroups (male, n=132, and female, n=39)

Forty one out of 68 subjects reported pain in the first two playing sessions. After the first two sessions a little less than 2 subjects (1.92) per playing session reported pain. After playing session 15 only two additional subjects reported pain (fig. 19). The result illustrates that the inclusion condition that each subject had to play a minimum of 15 playing sessions was meaningful. It also illustrates that the pain studied in this project was typical initial pain which may occur due to new tennis shoes! Some of the subjects reported the same pain more than once and others had multiple pain sites.

CUMULATIVE NO.
OF SUBJECTS
WITH PAIN

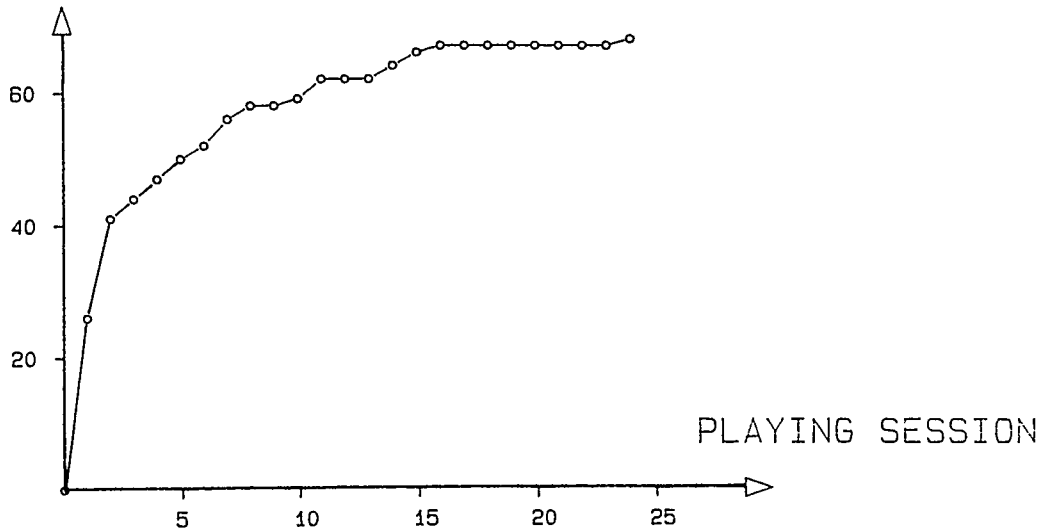

Figure 19. Cumulated number of subjects with pain as a function of the playing session (N=171).

Most of the 68 reported pain occurrences were discomfort (38 subjects or 55.1%). Pain occurred in 23 subjects (33.3%) and injuries in 8 subjects (11.6%). One subject suffered a first degree ankle sprain. First or second degree strain of the plantar ligaments occurred in 5 subjects. Two subjects reported a first degree strain of the hamstring muscles. Blisters occurred in 23 subjects, inflammations in 5 subjects, and 34 subjects reported other discomfort. These results are based on information of the medical questionnaire.

The site of pain was studied on the basis of the game questionnaire. It was assumed that the subjects were able to indicate where they felt pain. The results are illustrated in figure 19. The results show that 37 subjects reported pain at the toes, 24 at the forefoot, 14 at the heel, 12 at the arch, 7 at the ankle and smaller numbers at other pertinent sites.

For the relatively short period of approximately two controlled months, the major site of pain was the foot. Of all the reported pain (upper extremities excluded) 85% were in the foot. This is not consistent with the long-term investigation by Nigg and Denoth (1980). In this study, of 1018 subjects over a period of approximately one year, the pain frequency at the foot was only 30% of the sites comparable to the present study (fig. 20). This is another indication that the pain

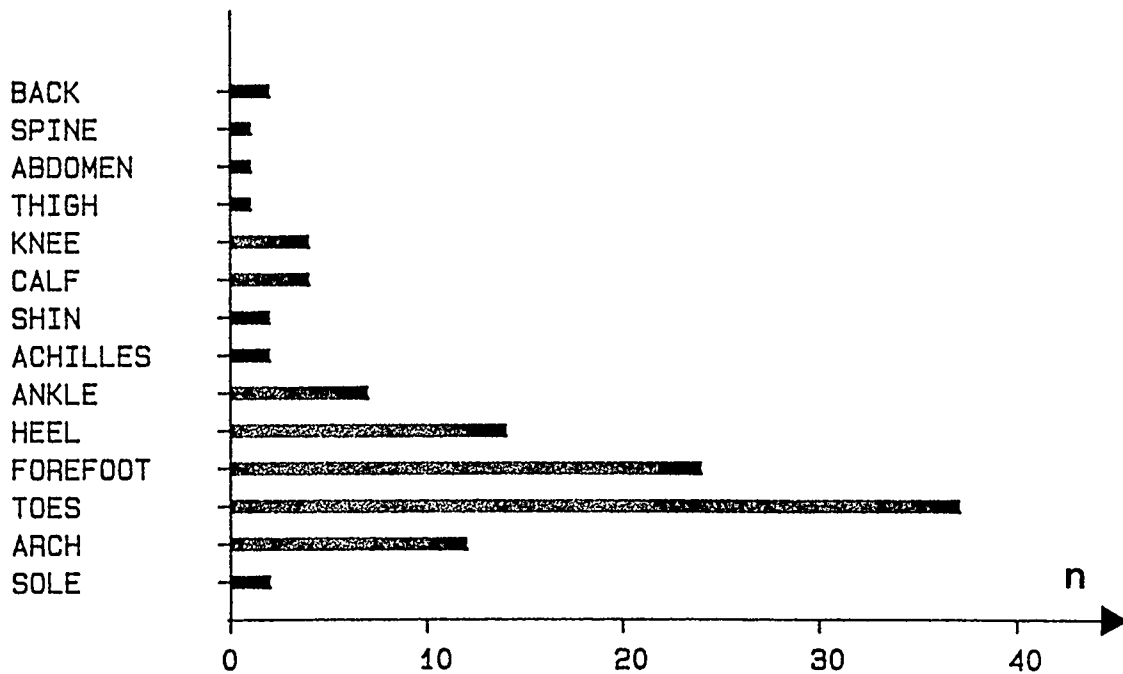

Figure 20. Number of subjects reporting pain as a function of the site of pain.

distribution in the present study is related to the use of new tennis shoes. Long-term effects which are very important in tennis have not been investigated in the present study.

The analysis of the pain group with regard to shoe showed that there is a significant difference in the occurrence of pain between the shoes. 32.6% of the subjects wearing shoe 1 were afflicted with pain, but 47.1% of the shoe 2 group reported pain (see fig. 21). Shoe 1 has the lower friction in comparison to shoe 2. The upper part of shoe 1 is relatively flexible while shoe 2 is harder (stiffer). More detailed information concerning shoes will be discussed in the biomechanical analysis (chapter 3.3). Since more females were wearing shoe 2, a significance test was performed to investigate whether there was a difference between the male and female subgroups for the variable shoe.

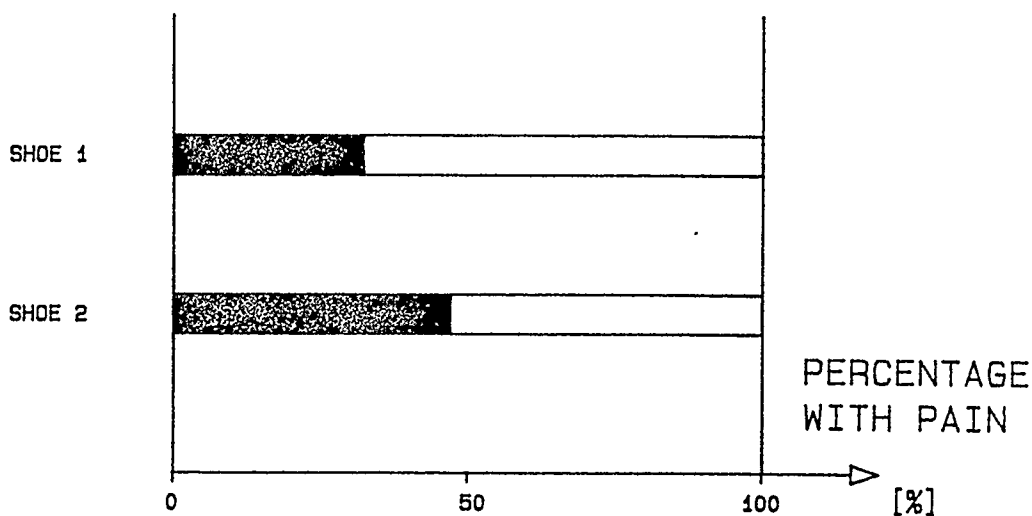

Figure 21. Occurrence of pain for the two shoe groups

However, no difference was found. Since the male group alone showed 32% with pain for shoe 1 and 48% for shoe 2 there was a strong indication that the shoe is an important factor for the occurrence of pain under the conditions of this study (new shoes at the beginning).

Furthermore, the results show that the site of pain is related to the type of shoe (fig. 22).

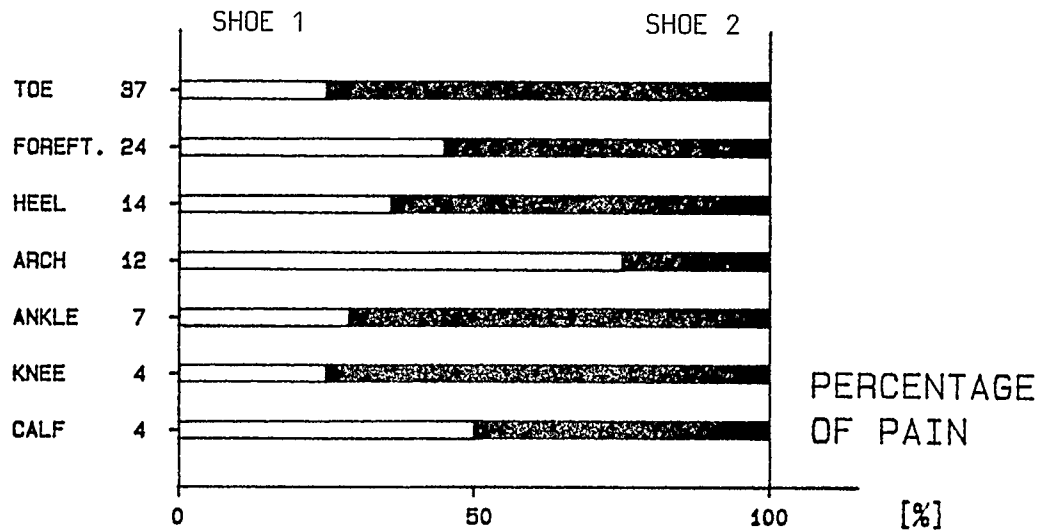

Figure 22. Influence of the shoe type on the site of pain

Shoe 1 has only 25% of toe and knee pain, 29% of ankle pain and 36% of heel pain. The distribution of the forefoot and calf pain is about 50% for both shoes. However, 75% of all arch pains were recorded for subjects wearing shoe 1. This result suggests that specific types of injuries are connected with certain shoe constructions. In this study it was not possible to pursue this line of reasoning further because of the limited information available from the game questionnaire. However, the biomechanical analysis will address this topic again.

It was not the intention of this study to consider the influence of the type of the surface on the occurrence of pain. The question was included in the questionnaire in order to control the situation. Most of the subjects played on asphalt and/or concrete. However, the

results of the questionnaire (which were not statistically analyzed) appear to follow the results of the previously mentioned study of Nigg and Denoth (1980) where small numbers of pain were reported for clay or "sand" (in this case 0% with pain) but more for synthetic and asphalt (in this study 6.6% for asphalt and 10.8% for synthetic courts).

4.1.3. Summary of general results

Out of the initial 229 subjects, 171 were used for the final analysis. The distribution of the population was in general satisfactory with the exception of the number of females (only 23% female) and their distribution to the different shoes (10 female with shoe 1 and 29 with shoe 2). About 40% of the subjects included in the final analysis reported pain and had a medical questionnaire completed. Pain was frequently reported in the first two playing sessions and less frequently afterwards. Discomfort was the dominant type of pain with 71.6% of all the cases. Only 8.6% reported injuries. The foot was the major site of pain (85%). Players wearing shoe 1 experienced pain less frequently than players wearing shoe 2.

4.2. Biomechanics

4.2.1. Organization of the results

The shoe construction as well as the individual dynamic behaviour of the test subjects are factors which influence load on the lower extremities in tennis. The organization of the results for each movement is therefore designed in the following way:

Results for movement i ($i = 1,2,3$):

- general description of the results
- comparisons of the results between:
 - shoe 1 and shoe 2
 - pain and no pain for shoe 1
 - pain and no pain for shoe 2
 - different types (sites) of pain

The results for each movement will be discussed separately. The different findings will be summarized at the end of the chapter.

4.2.2. Movement 1 (running)

a) General description of the results

The typical type of the vertical force curve for heel-toe running has been reported in biomechanics literature (Cavanagh and LaFortune, 1980; Nigg et al., 1980). A "high frequency" impact peak is usually demonstrated within the first 20-30 msec of the foot contact which is followed by a depression and a "low frequency" second peak (see fig. 23, Type I curve). The results of the present study, however, show some inconsistency with respect to occurrence of these impact peak forces. The typical force curve was demonstrated only in some of the trials. The measured curves can be subdivided into three general types of curves. The Type I curve shows a single impact peak. This type was

registered in about 70% of all the curves. The Type II curve has a characteristic double impact peak and accounts for about 10% of all curves. The Type III curve did not show a clear impact peak and was observed in about 20% of the measured curves.

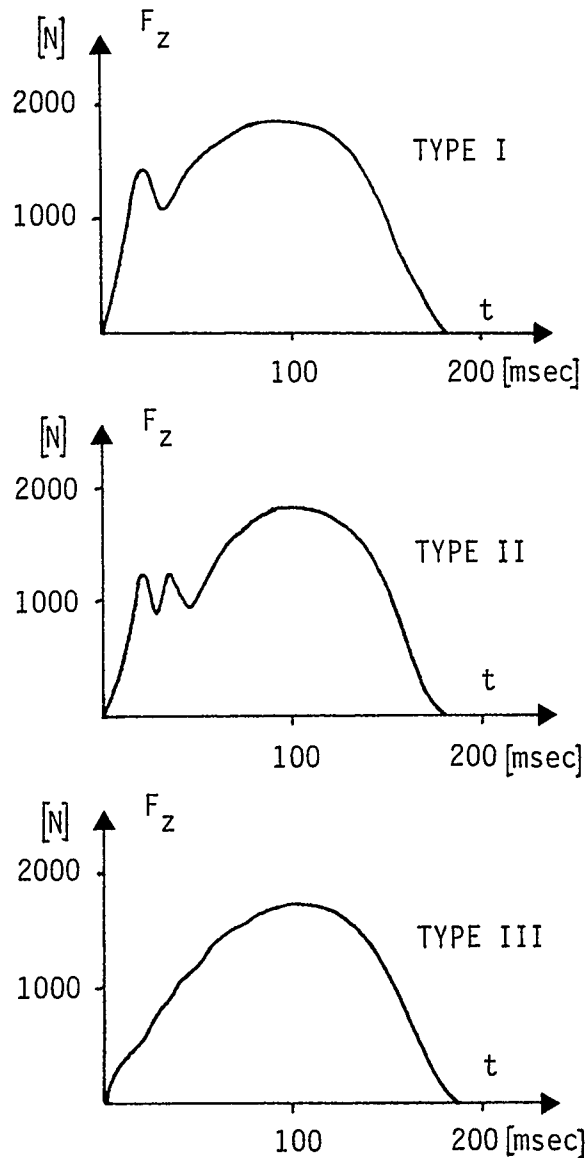

Figure 23. Principle types of vertical force curves for running (movement 1)

For further analysis the force time function is subdivided into three different time regions:

Region A: This region could be called the "initial loading" where a fast increase of the force can be observed. The time interval includes the first 15 msec of the foot contact. The force curve shows no oscillation in this region.

Region B: In this region the shape of the curve varies not only between the different types but also within the types. Eventually high frequency oscillation can be observed. The time interval of this region goes from about 15 msec to 50 msec.

Region C: This region includes the last part of the curve from about 50 msec to toe-off. The "active" peak (Nigg and Denoth, 1980) or "propulsive" peak (Clarke et al., 1982) is demonstrated in all of the trials.

The etiology of these different types of force curves is not entirely understood at the present time. Factors which could be responsible for the existence or absence of the impact peak forces are:

1. the movement of the foot during the landing phase;
2. the type of shoe, especially the construction of the shoe sole.

The first peak forces of the type I and type II curves can be explained with the movement. This type of force is the reaction of the impact of the rigid mass of the foot and leg (Nigg and Denoth, 1981). The magnitude of the force represents the product of the deceleration of the leg and the effective (decelerated) mass. This type of peak force generally appears if the first landing occurs with the heel. The second "high frequency" peak of the type II curve could be explained by the movement of the foot. This peak could represent a forefoot "slap" immediately after heel strike. This type of peak does not occur if the movement of the foot on the ground (from heel to toe) is a rolling movement. A stiff shoe sole could be the reason for this forefoot impact because the sole cannot be deformed very easily and therefore limits the rolling movement of the foot.

An attempt to explain the type III curves is more complicated. Forefoot landing was excluded, based on a qualitative check of each trial in the film. (9 trials were excluded from the analysis because of forefoot landing of the test subjects). However, the film frequency of 100 frames/sec is too slow to clearly differentiate between heel and flatfoot landing in a number of cases. It could therefore be that the absence of a first impact peak force is a result of flat foot landing. On the other hand, it was noticed that usually the harder types of shoe soles show less impact peaks. However, since movement and shoe are interconnected they influence each other. Kinematic and kinetic measurements with higher film frequencies would probably increase the understanding of this phenomena.

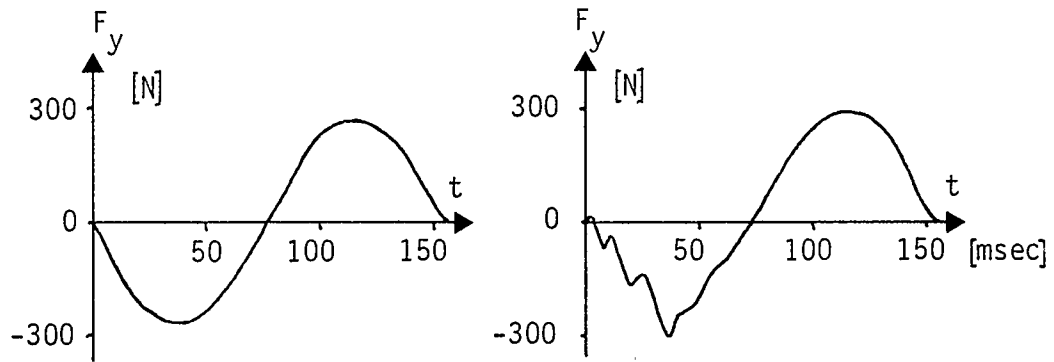

Figure 24. Examples of two a-p force curves for running (movement 1)

The anterior-posterior force curves follow in general the patterns of the "standard type" curve shown in figure 12. Sometimes high frequency oscillations are demonstrated in the first half (braking phase) of the curves. This is often the case if the corresponding vertical force curve is a type I or type II curve. About 75% of the trials with vertical type I and type II curves show these oscillations for the a-p force component (fig. 24, right). Different explanations are possible for the occurrence of these oscillations. They could be the

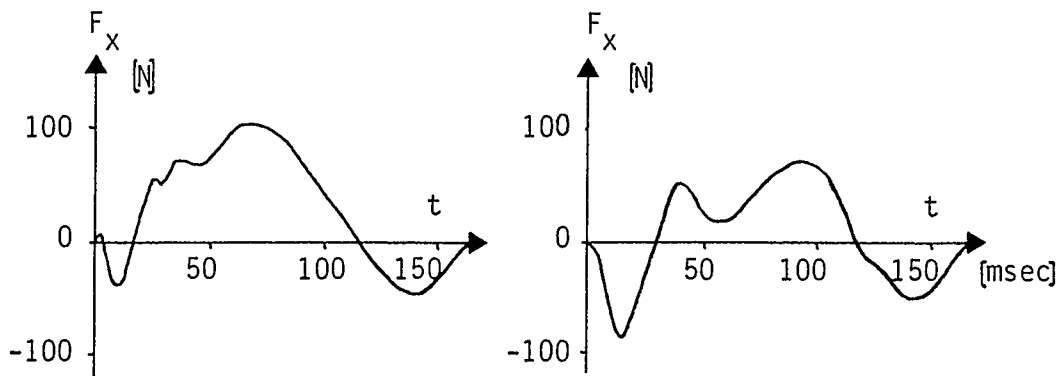

Figure 25. Types of lateral force curves for running (movement 1)

result of a fast weight transfer from heel to forefoot. In this case the corresponding vertical curve would be a type II curve. These oscillations could also be the result of fast sliding or hopping movements of the foot during the braking phase of foot contact.

The shape of the lateral force curves varies greatly between subjects. However, a "standard" type of curve can be seen throughout the trials and is shown in figure 12. The first peak force in the lateral

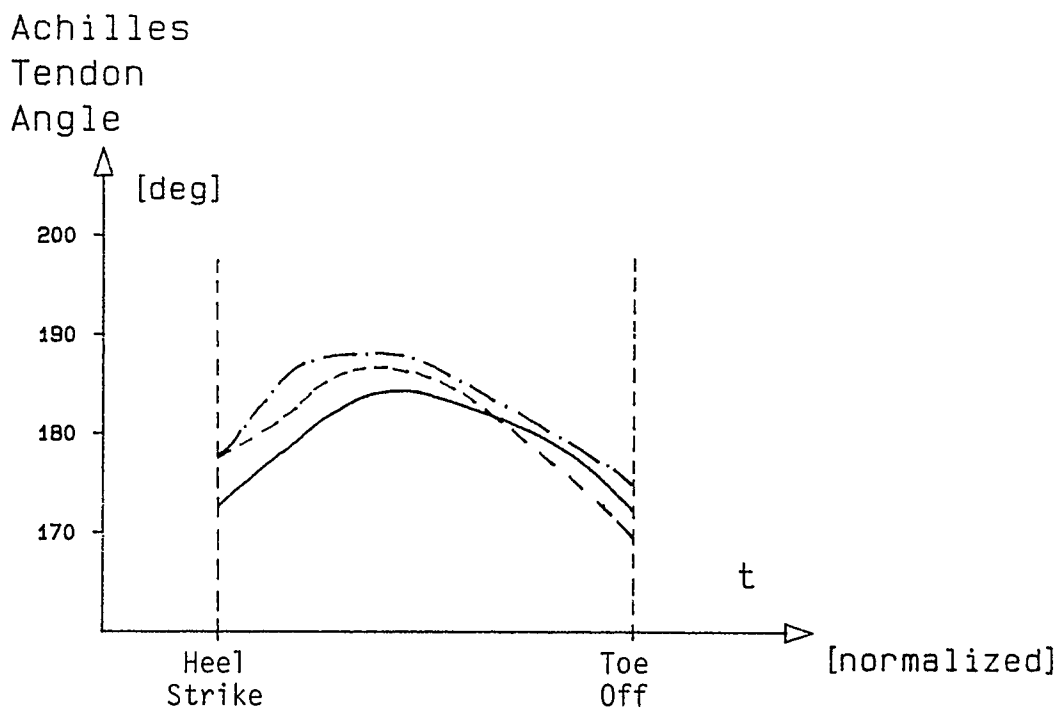

Figure 26. Curves for the achilles tendon angle β for three different test subjects

direction is the reaction to the impact and the initial pronation of the foot. The second part of the force curve describes the mid-stance phase and the propulsion of the foot. During this time the position of the foot changes from pronation to supination. There is a general feeling among researchers that high lateral forces should be avoided. However, the relationship between lateral forces and stability of the ankle joint is not yet known. To the knowledge of the author there is no publication in literature which sheds light in this area.

The time history of the achilles tendon angle β followed in general the patterns described by Nigg and Luethi (1980). The initial pronation in the first tenth of foot contact as well as the supination of the foot was demonstrated (see fig. 11). Both variables describe the lateral stability or instability of the ankle during ground contact. It has been reported by Nigg and Luethi (1980), that large changes in this angle are related to different types of pain in the foot and leg.

b) Comparison of the results between shoe 1 and shoe 2

The averages of the results of all test subjects playing with shoe 1 and shoe 2 are shown in table 7. A significant difference can be seen in the frequency of occurrence of the vertical impact force peak (f_I) for type I and type II curves. The force curves demonstrate this peak in 84% of the cases for the soft shoe 1 and in 53% for the harder shoe 2. The impact peak, if present, occurs sooner for the hard shoe. The same result was obtained for the time of occurrence of the maximal slope G_{zmax} . The lateral absolute impulse is higher for the soft shoe. Clear differences are shown by the kinematic variables (see fig. 27). The initial pronation is greater for shoe 2. The total supination, on the other hand, indicated by $\Delta\beta_{sup}$ is greater for shoe 1. The total amount of eversion/inversion at the ankle, $\Delta\beta_{tot}$, which can be used as an indicator of lateral stability of the foot (Nigg and Luethi, 1980) is higher for shoe 1.

Table 7 Comparison of the results of shoe 1 and shoe 2 for movement 1. (Means and Standard deviations). All differences between shoe 1 and shoe 2 are significant (student's t-test).

SHOE	f_I	n	t_{zG}	$\left \int_0^t F_x dt \right $	$\Delta\beta_{10}$	$\Delta\beta_{sup}$	$\Delta\beta_{tot}$	β_{end}	ϵ_0	V_z
	[%]		[ms]	[N.s]	[°]	[°]	[°]	[°]	[°]	[m/s]
1	84	170	21.1 (3.8)	9.6 (3.6)	8.2 (4.0)	24.0 (7.7)	41.6 (9.7)	172.6 (4.8)	137.0 (1.0)	0.74 (0.04)
2	53	159	16.8 (4.1)	8.6 (3.9)	9.8 (4.4)	20.0 (8.1)	38.0 (9.2)	177.2 (4.6)	138.6 (1.0)	0.83 (0.04)

The test subjects wearing shoe 2 showed slightly larger knee angles at heel strike and about 10% higher vertical impact velocities.

The influence of different shoe constructions on the kinematic and kinetic variables is clearly demonstrated by the results. Comparing the two shoes, the following summarized differences between the soft shoe 1 and the hard shoe 2 can be observed.

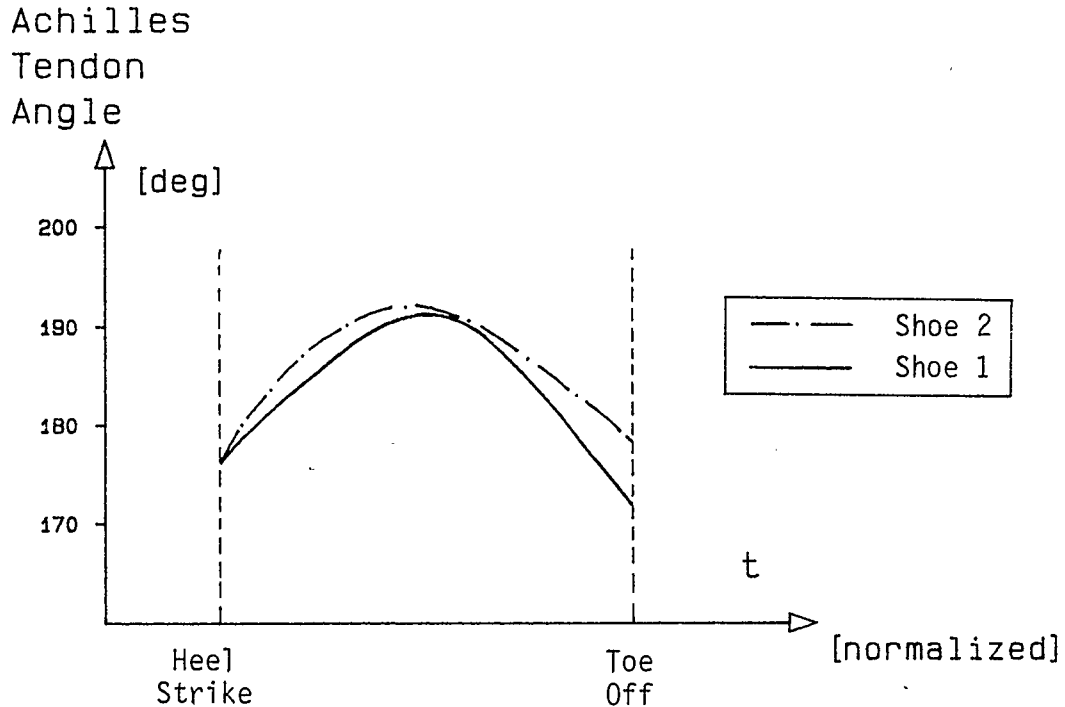

Figure 27. Average curves of the achilles tendon angle for shoe 1 (soft) and shoe 2 (hard)

- For shoe 1:
- the frequency of impact peak forces is greater
 - the time occurrence of the maximal slope is later
 - the lateral impulse is greater
 - the initial pronation is smaller
 - the supination is greater
 - the knee angle at first ground contact is smaller
 - the touch-down velocity is smaller

It could be assumed that the higher frequency of occurring impact peak forces is a disadvantage for the group wearing shoe 1 since it is felt that this type of force is dangerous because it cannot be controlled by muscular activity (Nigg and Denoth, 1980). On the other hand, the

magnitude of the forces, when normalized on body weight, is not different for the two shoes. The time interval from first contact till the time of occurrence of the maximal slope is longer for shoe 1 which is assumed to be an advantage. However, it is not clear at the present time whether the differences are relevant for occurring pain in tennis.

The greater lateral impulse for shoe 1 seems to correspond with the increased supinatory movement of the foot in the second phase of ground contact. Both results were described to be disadvantageous (Nigg and Luethi, 1980). Generally it can be said that shoe 2 gives better support to the foot during the stance phase in running except for the initial pronation at the beginning of the foot contact which is better controlled by shoe 1. The latter could be either the result of the insole in shoe 1 which has a medial support placed in the posterior half of the shoe or a consequence of the softer lateral edge of the shoe sole.

The knee angle and the vertical touch-down velocity determine the impact force for a given subject-shoe-surface combination at heel strike in running (Nigg and Denoth, 1980). If the knee angle and/or the touch-down velocity decreases then the impact forces in the ankle and knee joint will also decrease. Both the knee angle as well as the velocity of the foot before impact are smaller for shoe 1. The consequence is that on the average the forces in the knee joint are smaller for the group with shoe 1 compared to the group with shoe 2. This could influence the frequency of knee pain in tennis. However, the type of problems which may be produced by these types of forces are probably chronic problems which are not studied in this project (long-term effects).

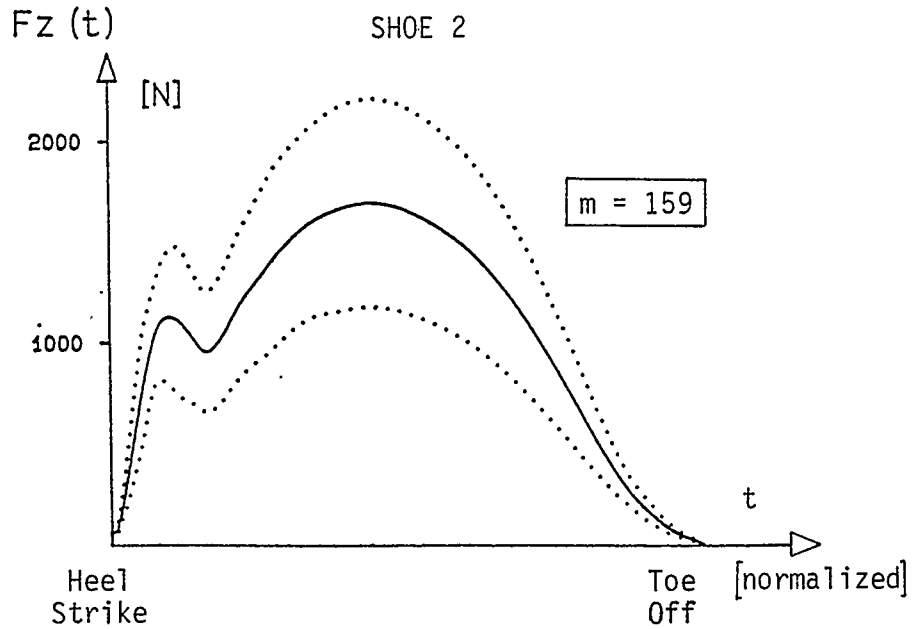
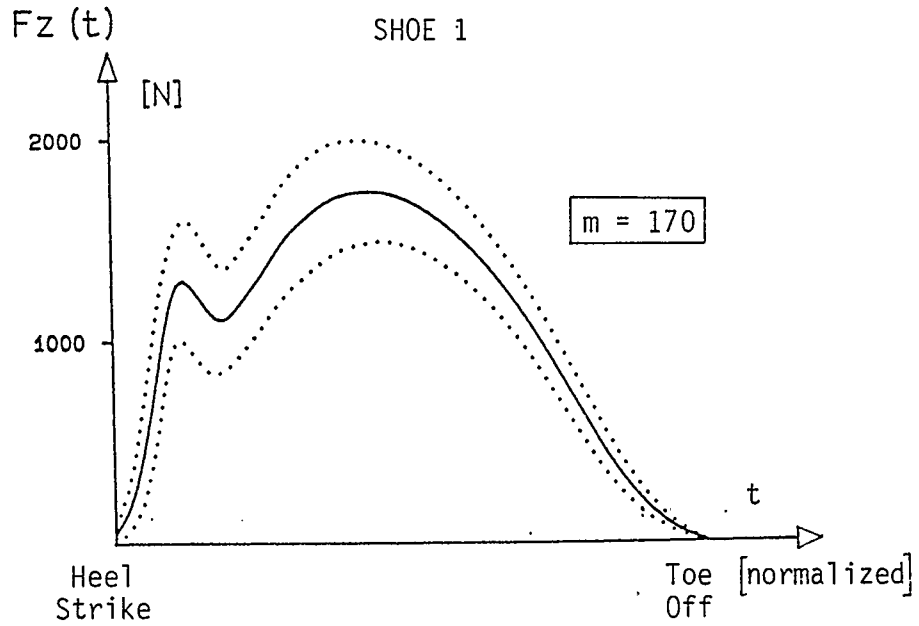

Figure 28. Average vertical force curves and standard deviations for shoe 1 and shoe 2 (running: heel-toe).

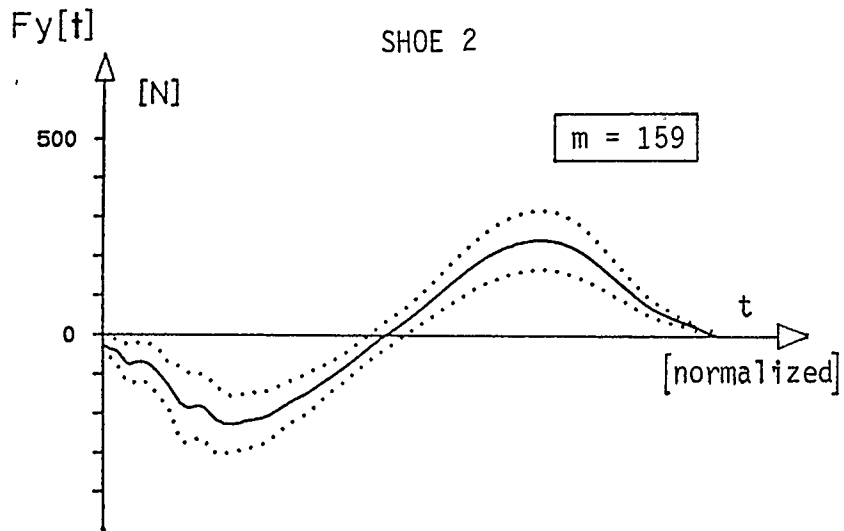
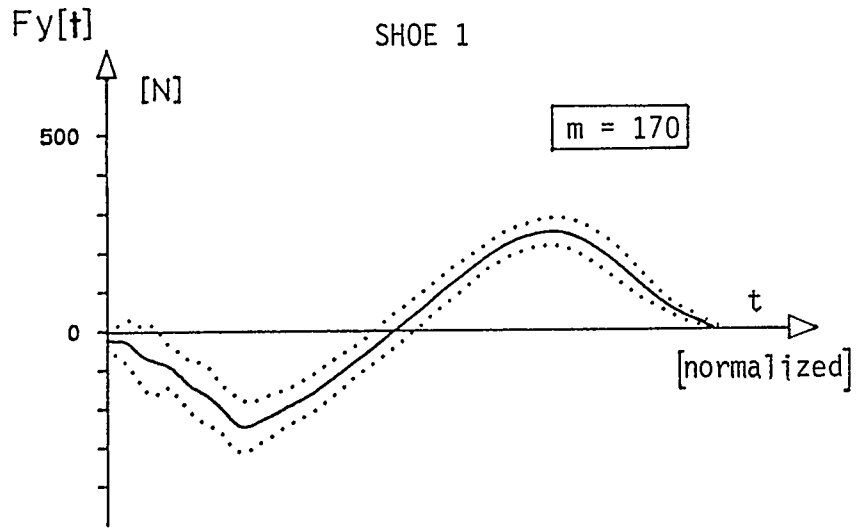
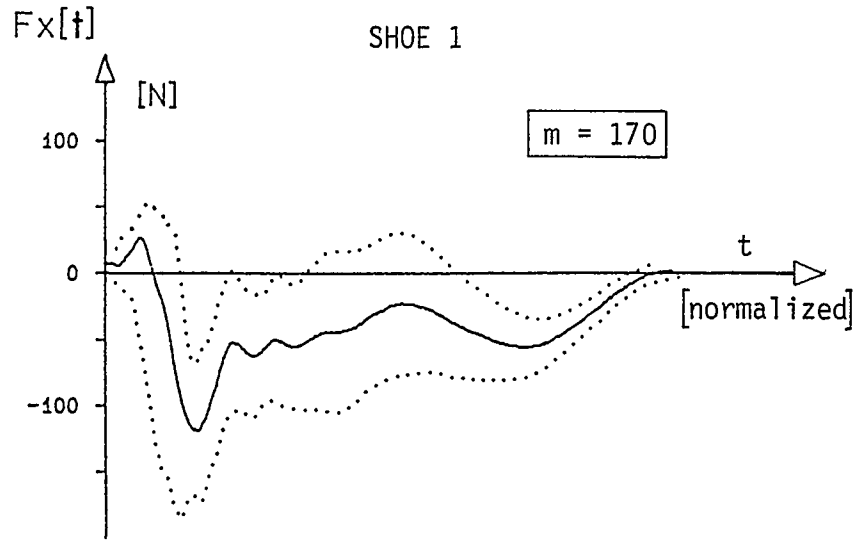

Figure 29. Average a-p force curves and standard deviations for shoe 1 and shoe 2 (running: heel-toe).



shoe 2

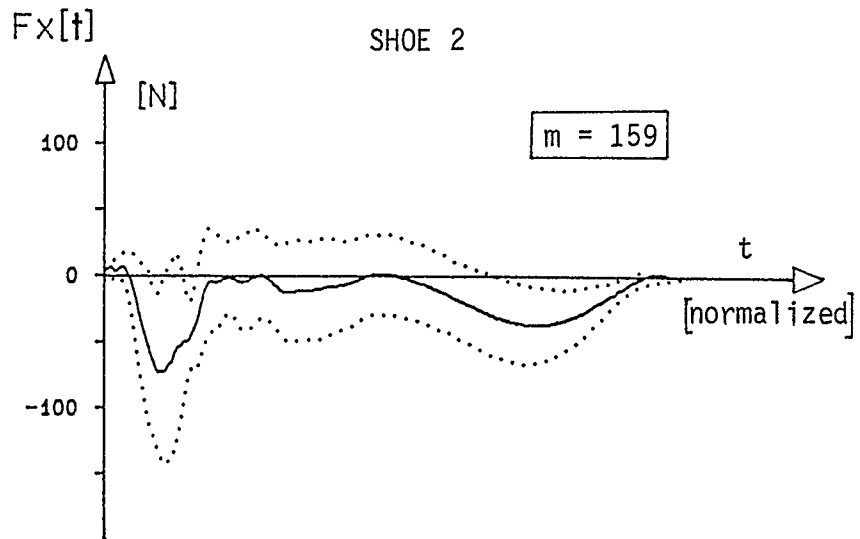

Figure 30. Average lateral force curves and standard deviations for shoe 1 and shoe 2 (running: heel-toe).

c) Comparison of the results between test subjects with pain and
test subjects without pain

Shoe 1 The vertical impact force shows higher maximum values for the group without pain.
 The kinematic variables differ in the second half of the foot contact. The supinatory movements are larger for the group with pain and so is the total amount of lateral movement.

Table 8. Comparison of the results for players with pain and players without pain for running (movement 1). (Means and standard deviations). Asterisks indicate significant differences. F_{z1} only calculated for type I and type II curves. m_1 = number of impact peaks. m_2 = number of cases for other variables.

SHOE	PAIN	n_1	F_{z1} [N]	f_I [%]	n_2	G_{zmax} [$10^3 \cdot N/s$]	$\Delta\beta_{sup}$ [$^\circ$]	$\Delta\beta_{tot}$ [$^\circ$]
1	yes	48	1371* (341)	83	58	75* (25)	25.5* (8.8)	43.2 (10.8)
	no	94	1465* (321)	84	94	80* (21)	23.2* (9.8)	40.8 (10.6)
2	yes	50	1267* (287)	62*	50	77* (22)	19.5 (7.7)	37.8 (8.5)
	no	36	1199* (386)	45*	36	71* (28)	20.7 (7.6)	38.1 (10.1)

Shoe 2: Table 8 shows that the vertical forces are higher for the group with pain. The differences of both the impact peak forces and the loading rates (G_{zmax}) are significant. The frequency of occurrence of the first impact peak (f_I) is considerably greater for the pain group compared to the non-pain group.

The results for the force curves were not expected. One would most likely expect that the vertical impact force peaks would be the same for both groups within one shoe type or if there is a difference one would expect that this would be consistent for both shoe groups. The three possible results within one shoe for the vertical impact forces are:

- a) $F_{pain} > F_{no\ pain}$: Obtaining this result one would assume that the ground forces are relevant for the occurrence of pain. One could speculate that the general site of pain would be the ankle joint.
- b) $F_{pain} = F_{no\ pain}$: This result would indicate that the impact peak forces are not relevant for occurring pain.
- c) $F_{pain} < F_{no\ pain}$: A possible explanation for this result could be that some test subjects show a protection behaviour in order to avoid high forces.

Similar results can be seen for the frequency of occurrence of the impact forces. It was noticed before that impact forces are considered to be critical for the load on the lower extremities. This would be in agreement with the results found for shoe 2 where the group with pain shows this peak more frequently than the group without pain. However, it is not consistent for shoe 1 where no differences can be seen as is illustrated in figure 31.

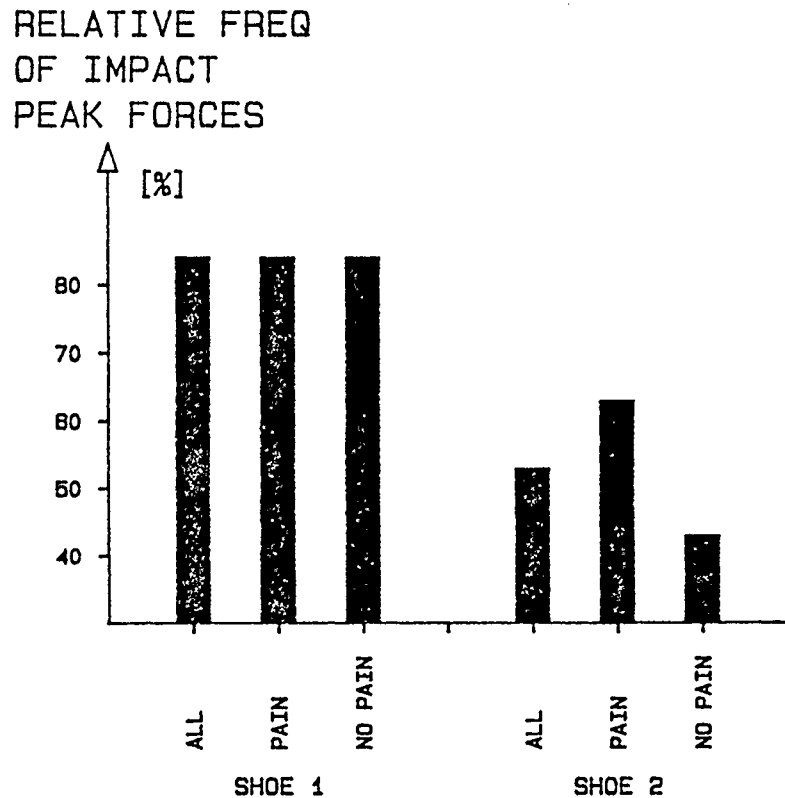

Figure 31. Relative frequency of impact peak forces in running with 2 different tennis shoes

It seems that the less rigid construction of shoe 1 creates some problems for the test subjects. The results from the group with pain wearing this shoe demonstrates higher rotational movements (inversion-eversion in the subtalar joint) compared to the group without pain. On the other hand, the ground reaction forces do not seem to have an influence on the occurrence of pain. The stiffer shoe seems to have the opposite effect. This shoe appears to be too stable for some test subjects (see fig. 32). This finding is connected with greater vertical impact forces and the higher frequency of these forces.

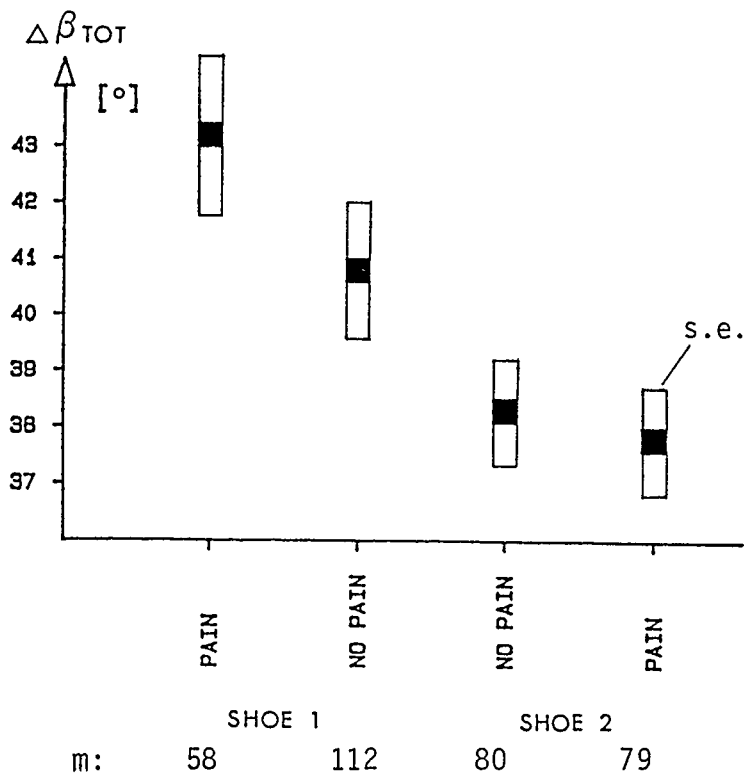

Figure 32. Total pronation/supination of the foot during ground contact for the two shoes

d) Results for different sites of pain

Table 9 shows a summary of the differences between the group with pain and the group without pain at each of the 7 specific pain locations. Since the number of subjects in the pain groups was very small no statistical analysis was done with the results. The comparison of the results was done qualitatively where the "+" in table 9 means a greater value compared to the group without pain and a "-" means a smaller value. "+" and "-" indicate a difference of at least 5%.

Table 9: Qualitative comparison of the results of different pain groups to the group without pain (+: value greater than the non-pain group; -: value smaller; 0: no difference. Difference means more than 5% deviation from the non-pain group). The forces are maximal forces.

SHOE	GROUP	n	F_z	F_y	F_x	$\Delta\beta_{10}$	$\Delta\beta_{sup}$	$\Delta\beta_{tot}$	ϵ_0	V_z
1	knee	1	0	0	0	0	0	0	0	0
	leg	3	-	-	-	0	+	+	0	0
	ankle	2	-	0	-	+	+	+	0	0
	heel	5	0	0	+	+	+	+	0	0
	arch	10	+	0	0	-	0	0	0	+
	forefoot	12	0	0	-	0	0	0	0	0
	toes	9	0	0	+	+	+	+	0	0
2	knee	3	0	0	0	-	-	-	+	0
	leg	5	+	0	0	0	+	+	0	0
	ankle	5	+	0	+	-	-	-	0	0
	heel	9	+	0	+	-	-	-	0	0
	arch	4	0	0	+	+	0	0	0	0
	forefoot	12	0	0	0	+	0	0	0	+
	toes	28	0	0	0	0	0	0	0	0

In general the results show different behaviour of the pain groups comparing shoe 1 and shoe 2.

Shoe 1: The influence of the magnitude of the maximal external forces on the occurrence of pain at different locations seems to be rather small except for the groups with heel and toe pain which show higher lateral forces (F_x) and the group with

arch pain which demonstrates greater vertical forces. Increased initial pronation is shown for three groups (ankle, heel and toes). Four groups demonstrate greater supinatory movements (leg, ankle, heel and toes). The same groups also show more total eversion/inversion of the foot. The knee angle is not different for any of the subgroups compared to the group without pain but the group with arch pain shows a higher touch-down velocity which is in agreement with the greater vertical force.

Shoe 2: Four subgroups (leg, ankle, heel and arch) show greater external forces. Two of the groups (ankle and heel) have higher vertical forces as well as lateral forces. The initial pronation is smaller or is not different for 5 subgroups. The groups with forefoot and arch pain, however, show an increased initial pronation. Supination and total eversion and inversion are generally smaller or show no difference compared to the group without pain. One exception is the group with leg pain which shows higher values. Knee angle and touch-down velocity differ in one case each. The group with knee pain shows a greater knee angle and the group experiencing forefoot pain demonstrates higher touch-down velocities.

The results for the different sites of pain support in general the findings of the previous chapters. The ground reaction forces do not seem to be a relevant factor in the occurrence of impairments in the lower extremities in running with shoe 1 as studied in this project. In addition, no consistent relationship can be found between lateral forces and pronation/supination. The movement, however, seems to be related to the occurrence of pain since four of the subgroups show either increased pronation or supination or a combination of both. This supports the general result that the soft and flexible shoe in many cases does not give enough support to the foot.

The results for the different pain groups playing with shoe 2 suggest that the ground reaction force in some cases can influence occurring pain. The fact that the shoe might be too stable and therefore can cause problems is indicated by the generally small lateral movements. An interesting result is the increased knee angle for the group experiencing knee pain. This would support the theory of Nigg and Denoth (1980) mentioned before. The consequence of an increased knee angle is also an increase in the effective mass which again results in higher compression forces in the knee.

e) Summary of the results for movement 1

The results found for running (movement 1) can be summarized in the following way.

- 1) Three different types of vertical ground reaction force curves can be seen:
 - a) curves which show a single impact peak force at the beginning of foot contact (type I curves)
 - b) curves with multiple impact peaks (type II curves)
 - c) curves where no sign of an impact peak can be seen (type III curves).
- 2) Impact peaks (type I and type II curves) occur more often for the soft shoe 1. However, the time interval between first contact and occurrence of the maximal slope is longer for shoe 1.
- 3) Generally more initial pronation is demonstrated by shoe 2, however, more supination in the second half of foot contact is shown for shoe 1.
- 4) Greater impact forces are found for the group without pain wearing shoe 1 compared to the group with pain. For shoe 2 the forces are higher for the group with pain.
- 5) No difference in the frequency of impact peaks can be seen comparing the two groups for shoe 1. The group with pain playing with shoe 2 demonstrates a higher frequency of these

peaks compared to the group without pain.

- 6) The different pain subgroups show generally small differences in the external forces but increased pronation/supination for shoe 1 and increased forces and smaller pronation/supination for shoe 2.

Generally it can be said that the shoe construction significantly influences the movement patterns in running. The influence of the construction characteristics of the two different shoes can be described quite well. It seems that a tennis shoe can be either too stable or not stable enough. Both could be reasons for a tennis player experiencing pain if this movement is relevant for the occurrence of pain in tennis.

4.2.3. Movement 2 (running-stopping)

a) General description of the results

Figure 33 shows typical force curves for the vertical and the anterior-posterior direction. Both force components demonstrate one or two sharp peaks within about 20 msec of contact. The magnitude of these force peaks can easily reach three or four times body weight. The examples A and C in figure 33 show the double peak where the first peak demonstrates the heel landing immediately followed by the impact of the forefoot, whereas the single peak in example B is probably produced by a flat foot landing. The magnitude of the lateral forces are very small compared to the other components.

In this movement the shape of the force curves look quite different compared to running (movement 1). The test subjects were instructed to strike the ground with the heel first and to stop immediately on one foot. Figure 32 illustrates that the magnitude of the vertical peak forces is about the double of the magnitude of the anterior-posterior forces. Comparing the two components of the touch-down velocity

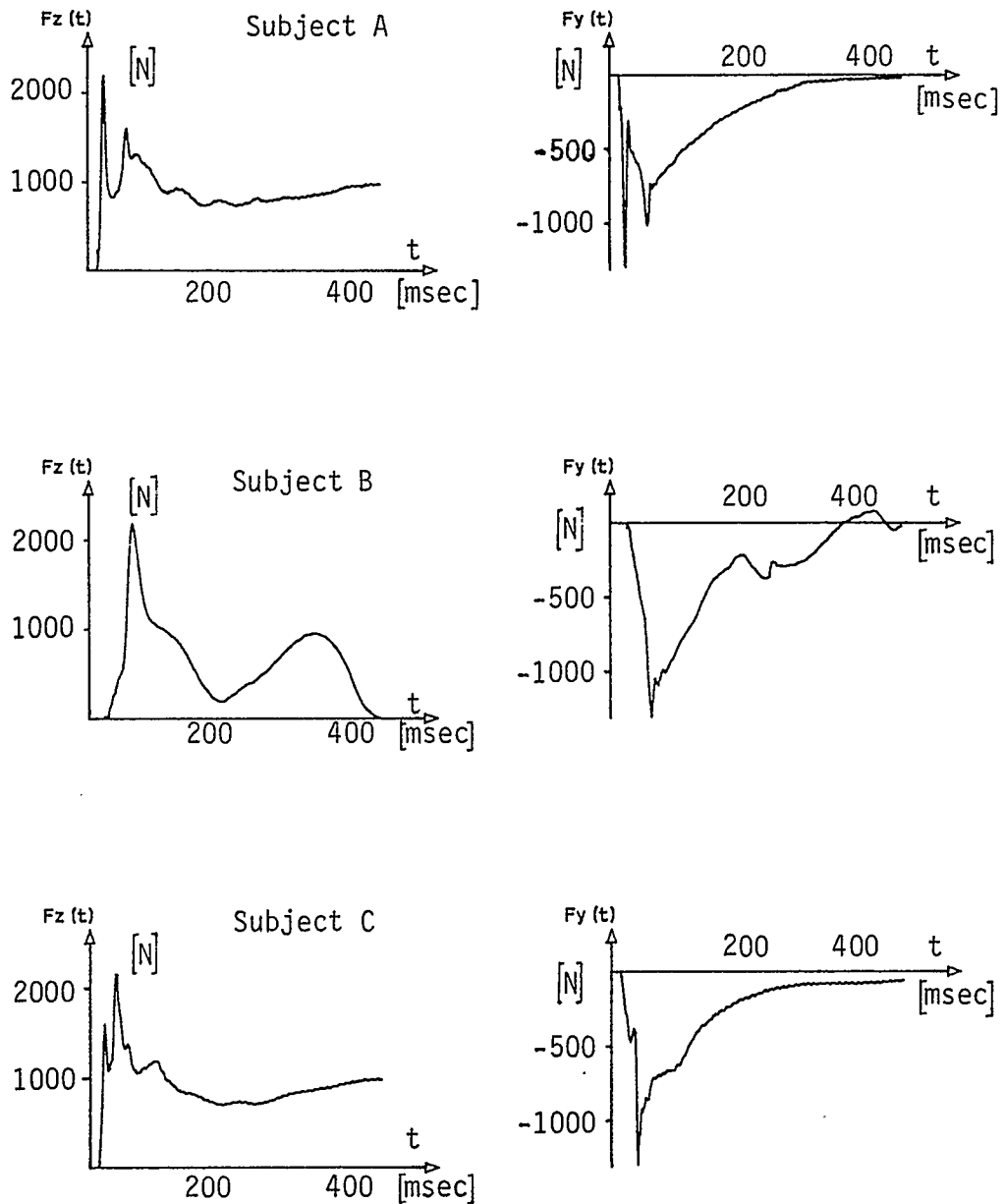

Figure 33. Examples of typical vertical and a-p ground reaction forces for running-stopping (movement 2) for three different subjects

vector, it can be seen that the a-p component (2.5 m/sec) is about two and a half times the vertical component (1 m/sec). The direction of the resultant ground reaction force therefore is in the average about 61° to the horizontal which means that the shear forces acting on the

ankle, the subtalar joint and the knee joint can be very large. The knee angle at touch-down is on the average about 145 degrees which is slightly higher than in running (movement 1). An initial pronation of the foot can be observed during about the first 30 msec of foot contact. This pronation will be described using the change of the achilles tendon angle during the first 30 msec of foot contact.

b) Comparison of the results between shoe 1 and shoe 2

The subjects wearing shoe 1 show higher maximal vertical forces compared to the group playing with shoe 2. However, when normalized with the average body weights of the two groups, the magnitude of the vertical forces do not differ (3.1 BW for both groups). The a-p shear forces are not different. The knee angle at touch-down, ϵ_0 , is the same for both groups (147 degrees). The direction and magnitude of the touch-down velocities are different for the two shoes. The velocity in the vertical direction is greater for the group with shoe 1. In the anterior direction no significant difference can be seen. The initial pronation $\Delta\beta_{30}$ is smaller for shoe 1.

Table 10. Results of selected variables for shoe 1 and shoe 2 for running-stopping (movement 2). Means and standard deviation (student's t-test). Asterisks indicate significant differences

SHOE	m	F_{zmax} [N]	F_{ymax} [N]	$\Delta\beta_{30}$ [°]	V_z [m/sec]	V_y [m/sec]	ϵ_0 [°]
1	161	2317* (668)	1260 (411)	6.6* (4.8)	1.14* (0.07)	2.64 (0.15)	146.9 (2.2)
2	170	2114* (611)	1191 (403)	8.5* (5.4)	1.05* (0.06)	2.67 (0.12)	147.1 (1.8)

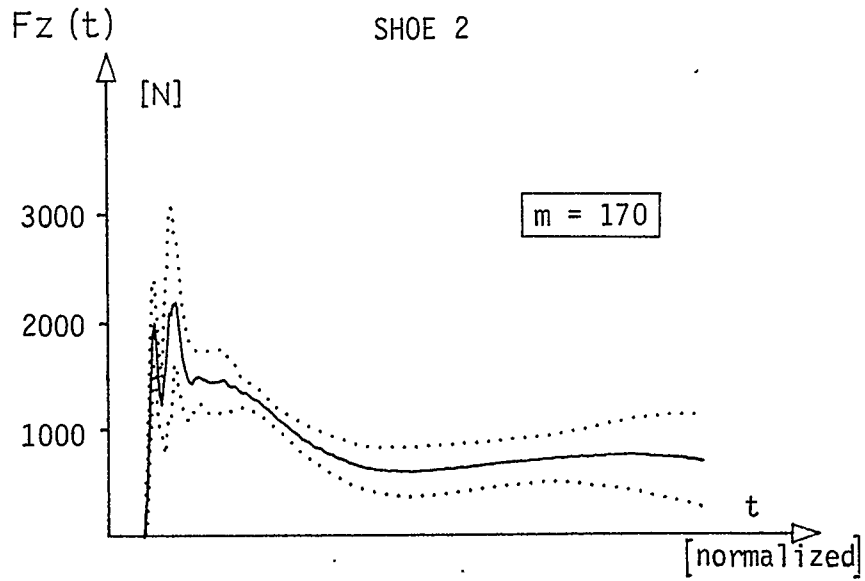
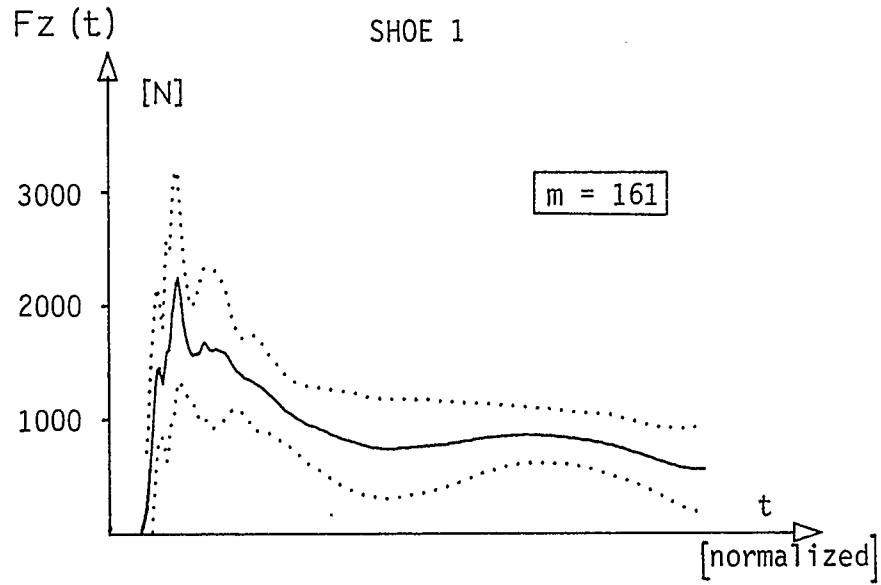

Figure 34. Average vertical force curves and standard deviations for shoe 1 and shoe 2 for running-stopping (movement 2).

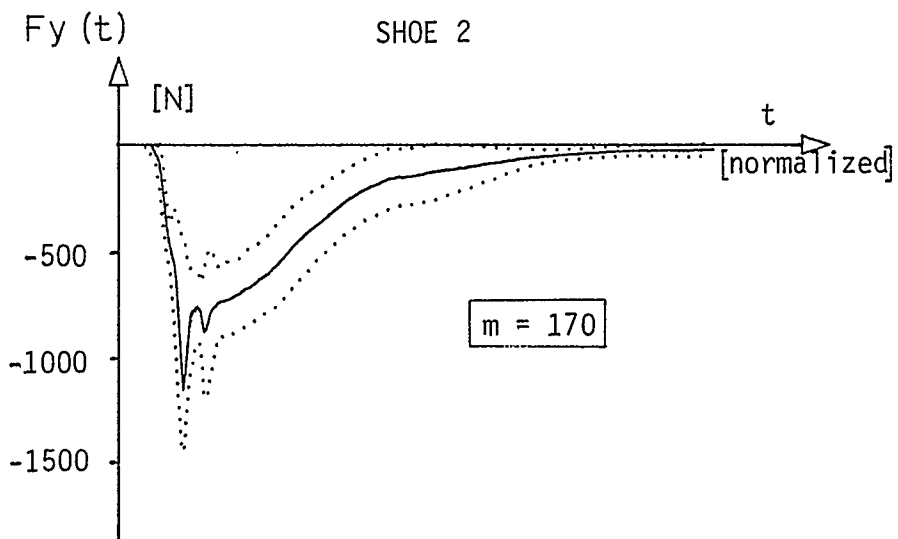
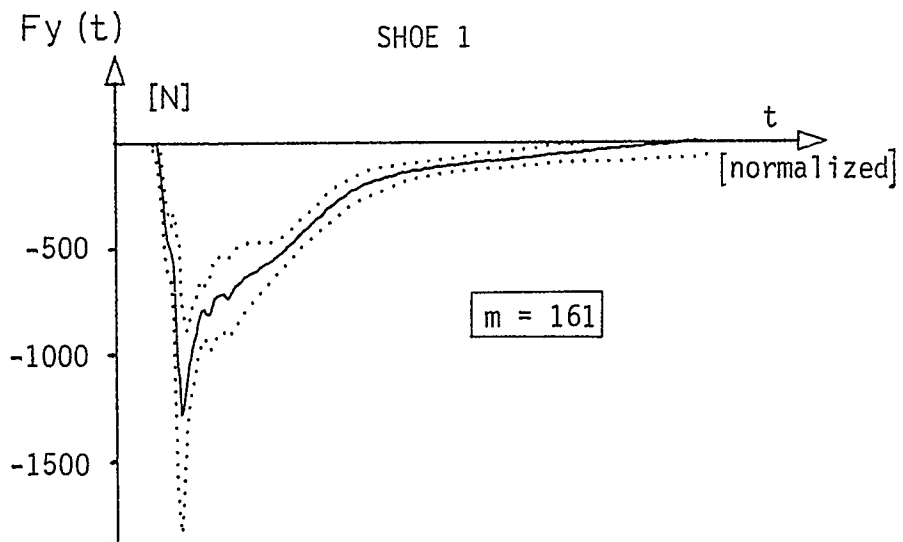

Figure 35. Average a-p force curves and standard deviations for shoe 1 and shoe 2 for running-stopping (movement 2)

The combination of less pronation but greater forces vs. more pronation but smaller forces could at least partially explain the higher forces of the group playing with shoe 1. This means if the system foot-leg is kept very stable at the moment of impact then the forces have to be absorbed mainly by the bones and associated joints. In this case the system acts more like a rigid body which as a consequence produces the higher reaction forces. If pronation occurs then part of the energy is absorbed by other structures of the foot, in this case the medial collateral ligaments and the extrinsic medial muscles and tendons of the foot (tibialis posterior, flexors hallucis and digitorum longus). Another possible explanation for the higher vertical forces of the group with shoe 1 is the higher vertical touch-down velocity.

c) Comparison of the results between test subjects with pain and those without pain

The results in table 11 illustrate that the vertical and a-p forces are not different between the pain and no pain groups. The pronation in the first 30 msec of foot contact is greater for the group without pain for shoe 1. This variable shows no difference for the two groups wearing shoe 2.

The vertical component of the touch-down velocity is higher for both groups without pain. Both pain groups show smaller knee angles compared to the corresponding groups without pain.

The results suggest that the ground reaction forces are not relevant variables for this movement comparing the groups without pain and the groups with pain in general. However, this statement is only valid for the experimental set-up used in the present study. It may well be that a variation of the velocity of the movement and/or the type of movement could change this picture. The results of the touch-down velocity indicate a different movement behaviour between the two groups in the time interval before heel strike. That means that the anterior-

posterior velocity component is more dominant for the groups with pain compared to the groups without pain.

Table 11. Comparison of the result of selected variables between test subjects with pain and those without pain (means and standard deviations). Asterisks indicate significant differences (student's t-test)

SHOE	PAIN	m	F_{z1} [N]	F_{y1} [N]	$\Delta\beta_{30}$ [°]	V_z [m/sec]	V_y [m/sec]	ϵ_0 [°]
1	yes	51	2267 (676)	1183 (431)	7.6* (5.3)	1.05* (0.09)	2.81* (0.18)	145.4* (2.9)
	no	110	2340 (665)	1295 (394)	6.1* (4.4)	1.16* (0.06)	2.53* (0.13)	148.7* (2.4)
2	yes	82	2091 (576)	1202 (376)	8.5 (5.5)	1.00* (0.06)	2.72* (0.16)	146.1* (1)
	no	88	2139 (698)	1180 (422)	8.5 (5.4)	1.10* (0.06)	2.63* (0.10)	148.5* (1)

The findings, however, suggest that more information can be obtained from the results of the different pain subgroups. If this movement is relevant for the occurrence of discomfort and pain in tennis then this more detailed analysis seems appropriate.

d) Results for different sites of pain

The ground reaction forces are generally smaller for the test subjects with pain compared to the groups without pain. The exceptions are the ankle, heel and forefoot pain groups for shoe 2 and the group with arch

pain for shoe 1 which show greater a-p forces. The groups with toe and ankle pain playing with shoe 2 demonstrate greater vertical forces. The players wearing shoe 1 and suffering one of these types of pains show a greater amount of lateral movement and an increased vertical touch-down velocity of the foot, whereas the test subjects playing with shoe 2 had a very small initial pronation and also a lower touch-down velocity. In 8 out of 14 pain subgroups the knee angle at heel contact is smaller than for the group without pain and in only one case (toe pain, shoe 1) is this angle is larger.

Table 12. Qualitative comparison of the results of different pain groups to the "non-pain" group. (+/- means greater/smaller values than the "non-pain" group, 0 means no difference). A "+" or "-" means a difference of at least 5% from the non-pain group.

SHOE	PAIN GROUP	n	F_{z1}	F_{y1}	$\Delta\beta_{30}$	V_z	V_y	ϵ_0
1	knee	1	0	0	0	0	0	0
	leg	3	-	-	0	0	+	-
	ankle	2	-	-	+	+	-	-
	heel	5	-	-	+	+	-	-
	arch	10	-	+	+	+	+	-
	forefoot	12	-	-	-	-	+	-
	toes	9	0	-	-	-	-	+
2	knee	3	-	-	-	0	+	-
	leg	5	-	-	+	-	-	-
	ankle	5	+	+	-	-	+	0
	heel	9	0	+	-	-	+	0
	arch	4	-	-	-	0	0	0
	forefoot	12	-	+	+	0	-	0
	toes	28	+	-	-	-	+	-

The external forces seem to have an influence on the occurrence of pain at specific locations of the foot although no differences can be found by comparing the total groups with pain and without pain. In all cases (except forefoot pain, shoe 2), the higher forces are combined with increased frontal touch-down velocities. These results would indicate higher frontal shear forces in the various structures of the foot which could result in pain occurring. The results illustrate that the forces are more critical for the groups playing with the hard shoe (shoe 2). The second finding is that the subjects who played with shoe 1 and suffered either ankle, heel or arch pain show an increased pronation at the beginning of foot contact. The corresponding pain groups playing with shoe 2, however, demonstrate a decreased pronation. This result, which is in agreement with the results for movement 1, suggests that for some of the players the soft shoe (shoe 1) is too unstable and therefore cannot give the necessary support to the foot. On the other hand, the hard shoe (shoe 2) seems to be too stable for some of the test subjects. Both phenomena seem to be connected with pain.

e) Summary of the results for movement 2

Running and stopping is a type of movement which occurs very often in tennis and it is felt that this movement can be relevant to the occurrence of pain. The findings for this movement are:

- 1) The vertical and frontal ground reaction forces at the moment of impact can be very high (3 times body weight or more). No difference has been found between the groups with pain and without pain. The analysis of the different pain subgroups, however, suggests that the magnitude of the external forces may be relevant to the occurrence of foot pain (ankle, heel, forefoot and toes).
- 2) The pronation in the first 30 msec of foot contact is mainly influenced by the type of shoe. The group wearing the shoe with the hard sole (shoe 2) shows more pronation. However,

no consistency can be seen by comparing the groups with pain and the groups without pain. It seems that pronation is not a relevant variable in this movement.

- 3) The direction of the touch-down velocity of the foot is different between the groups with pain and without pain. The frontal component is more dominant for the pain group. It seems that this variable, in combination with the frontal shear force, could be relevant to the origin of pain.
- 4) The knee angle seems to have an influence in this movement. It can be seen that the angle is smaller for the group with pain. One could assume that a small knee angle results in an increase in the inertial rigid mass in the a-p direction and therefore influences the magnitude of the frontal shear forces in the joints. The development of an analytical model could probably give an answer to this problem.

4.2.4. Movement 3 (hopping sideways)

a) General description of the results

Despite the fact that this movement is very complex and great variations were expected in the execution of the movement among the subjects, three typical force curves can be distinguished for the vertical as well as for the lateral component. All test subjects contacted the force platform with the forefoot first. This toe contact can be seen in about 40% of the force curves in form of a first small peak at the beginning of the curves. About 10 msec after toe contact a second higher peak can be seen indicating the landing of the heel. This second peak is identical in over 85% of the trials with the maximal external force exerted to the foot and the leg. A third peak describes the take-off phase of the foot contact. In about 15% of the measurements this peak is identical with the maximum of the forces.

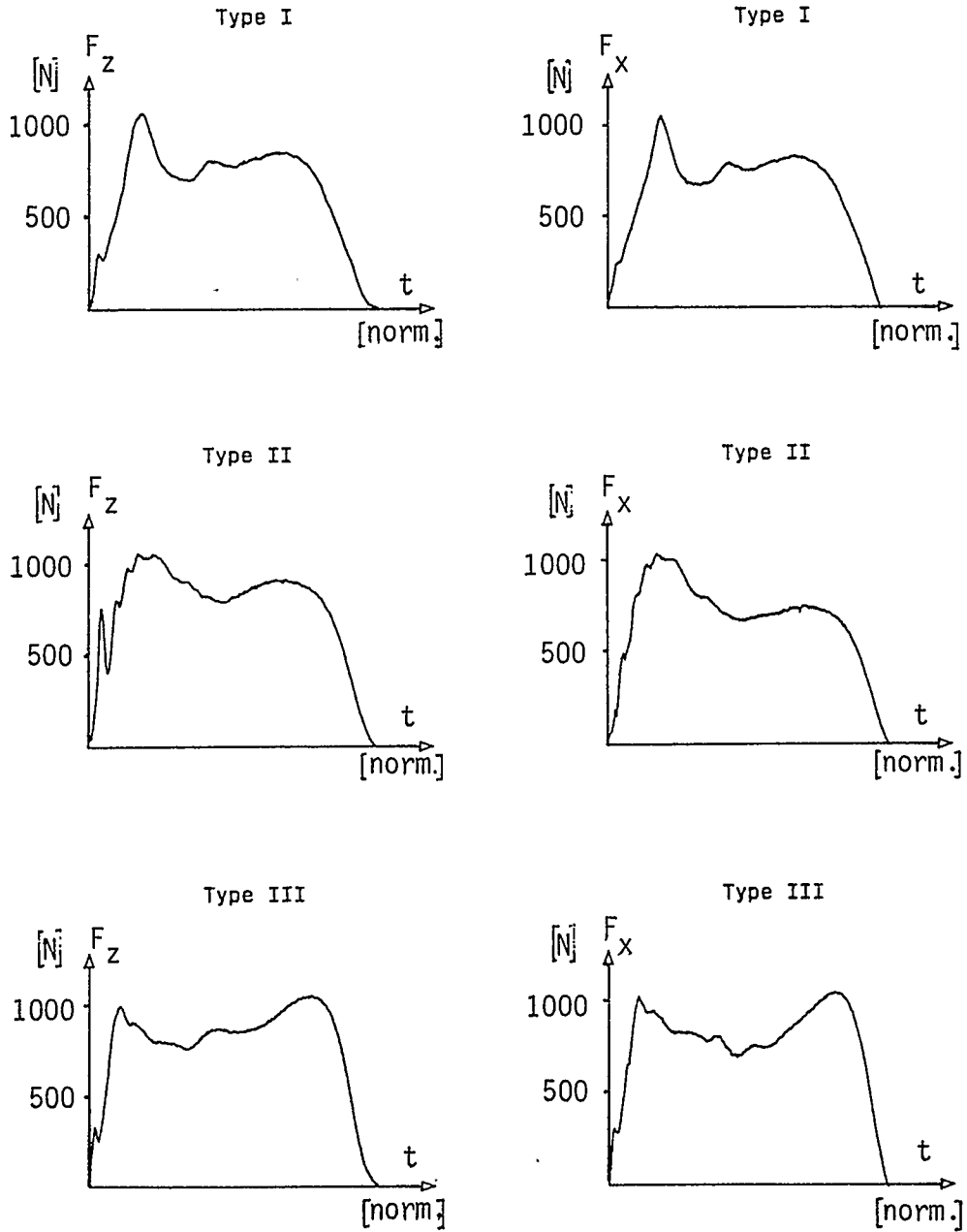

Figure 36. Typical vertical and lateral force curves for hopping sideways (movement 3) for three different subjects

The geometrical configuration of the movement immediately before foot contact (fig. 37, right) is remarkably constant for all subjects with only small variations. The angle between the lower leg and the horizontal, α_{-10} was on the average 57 degrees, and the initial achilles tendon angle, β_{-10} was 171 degrees. The direction of the movement of the foot before contact is mainly lateral rather than vertical. The magnitude of the lateral touch-down velocity, V_x was on the average about 5 times the magnitude of the vertical component (about 3.5 m/sec for the lateral direction and about 0.7 m/sec in the vertical direction). This corresponds to a touch-down angle of the resultant velocity vector of 10-15 degrees measured to the horizontal

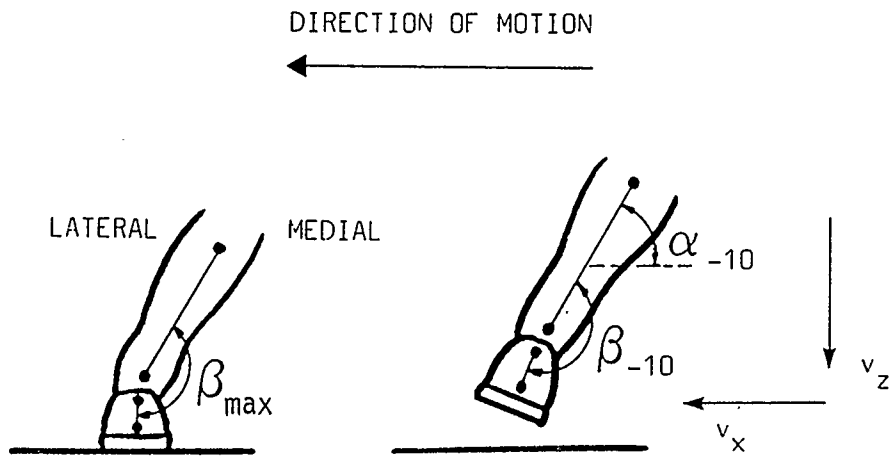

Figure 37. The geometry of the foot and lower leg before contact (right) and the position of "maximum inversion" of the foot (left) in hopping sideways (movement 3).

line. Immediately after the first contact the foot usually starts to invert. The maximum amount of inversion during the first 50 msec after the first contact, $\Delta\beta_{\max}$, varies among the test subjects and depends on the shoe construction and the individual dynamic behaviour. The angle β_{\max} , indicating the maximum inverted position during the first 50 msec (fig. 37, left) can reach values as low as 140 degrees. After reaching maximum inversion the foot and the lower limb start to rotate medially in order to have a more favourable position for the take-off phase.

Although the test subjects were instructed to land with flat foot it seems that this is not possible if the movement is performed fast. The majority of the subjects contacted the platform with the toes first, probably as a result of a protection mechanism. The force peaks produced by the toe landing was usually small (<200 N). This force peak was not considered as relevant and therefore was not included in the analysis. The maximum forces for the vertical and lateral directions were analyzed for the first 150 msec of foot contact. The small variations in the geometry of the movement before contact is an interesting result which was not expected.

b) Comparison of the results between shoe 1 and shoe 2

The comparison of the force results between shoe 1 and shoe 2 shows differences for the lateral component (see table 13). The group wearing the soft and flexible shoe 1 have on the average higher maximum lateral forces. This result corresponds to the greater lateral touch-down velocities for the same group. Large differences were measured for the kinematic variables. Although the geometry of the movement before ground contact of the foot, described by α_{-10} and β_{-10} is not different between the two shoes, the maximum inverted position of the foot, β_{\max} and thus the total amount of inversion, $\Delta\beta_{\max}$ differs between the two shoes. The flexible shoe (shoe 1) shows 22 degrees of inversion during the first 50 msec, shoe 2 only 13 degrees.

Table 13. Comparison of the results between shoe 1 and shoe 2 for hopping sideways (movement 3). Means and Standard deviations (t-test). Asterisks indicate significant differences.

SHOE	m	$F_{x\max}$ [N]	α_{-10} [°]	β_{-10} [°]	β_{50} [°]	$\Delta\beta_{50}$ [°]	$\Delta\beta_{air}$ [°]	$\Delta\beta_{heel}$ [°]	v_x [m/s]
1	139	992* (293)	57.4 (3.1)	170.5 (8.4)	148.4* (9.1)	22.2* (5.2)	10.1* (6.7)	12.1* (4.4)	3.7 (1.2)
2	140	919* (341)	57.3 (3.3)	171.2 (8.1)	158.0* (7.4)	13.3* (5.4)	7.3* (4.2)	6.1* (5.3)	3.4 (1.2)

With the stiff shoe (shoe 2) the greater part of inversion takes place between toe contact and first heel contact during the first 10 msec (see fig. 38). More than 50 percent of the inversion with shoe 1 occurs between 10 and 50 msec. This result that the stiffer shoe produces more initial ankle motion confirms the results found in movement 1 and 2. This could be explained by the stiffer sole of the shoe which prevents a rolling movement of the sole during foot contact. The flexible shoe (shoe 1) which can be deformed more easily leads to an increasing lateral instability of the foot in the second part of ground contact.

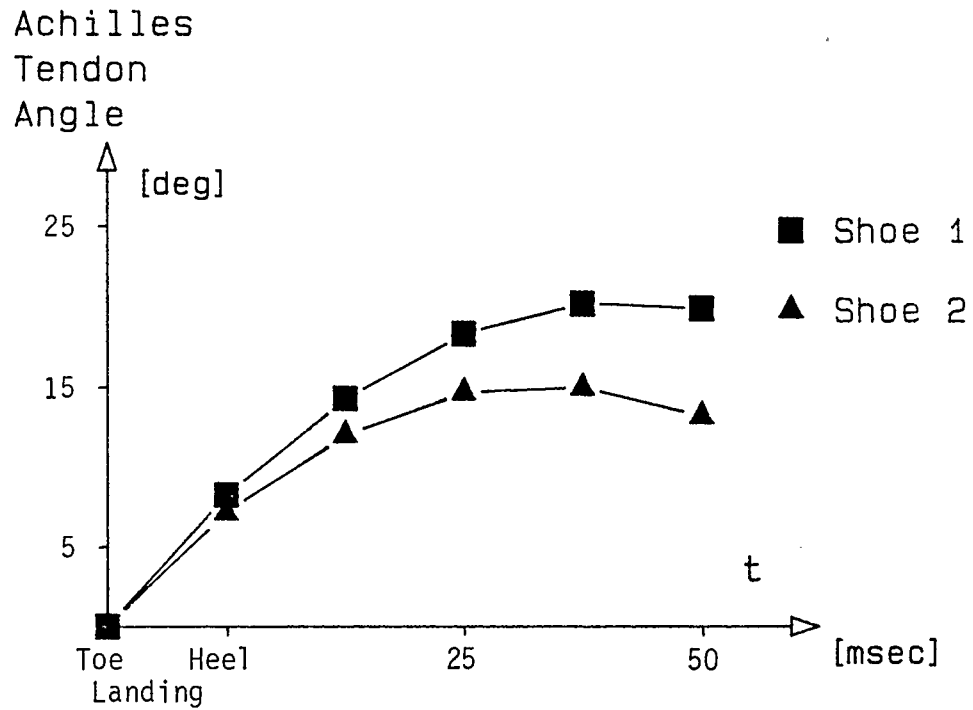

Figure 38. The time history of the Achilles tendon angle (indicating inversion of the foot) during the first 50 msec of foot contact. Average curves for the two shoes ($m_1 = 139$, $m_2 = 140$).

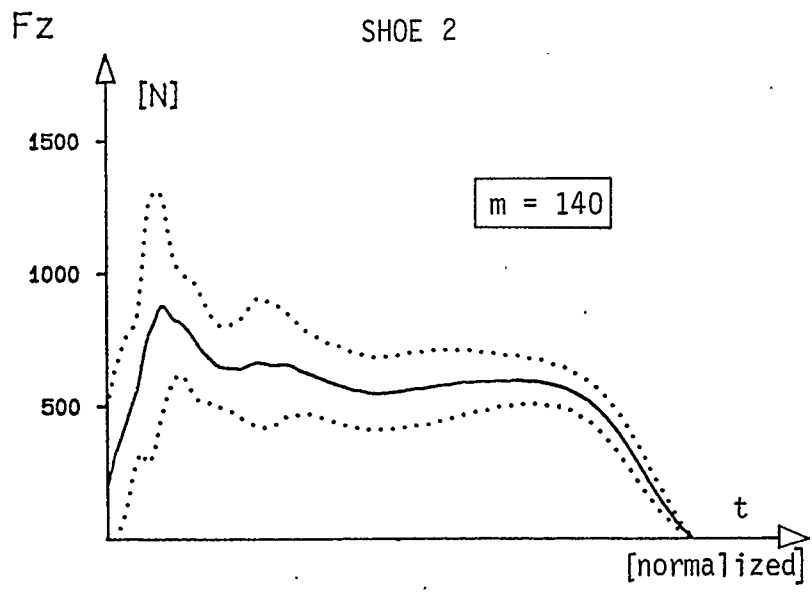
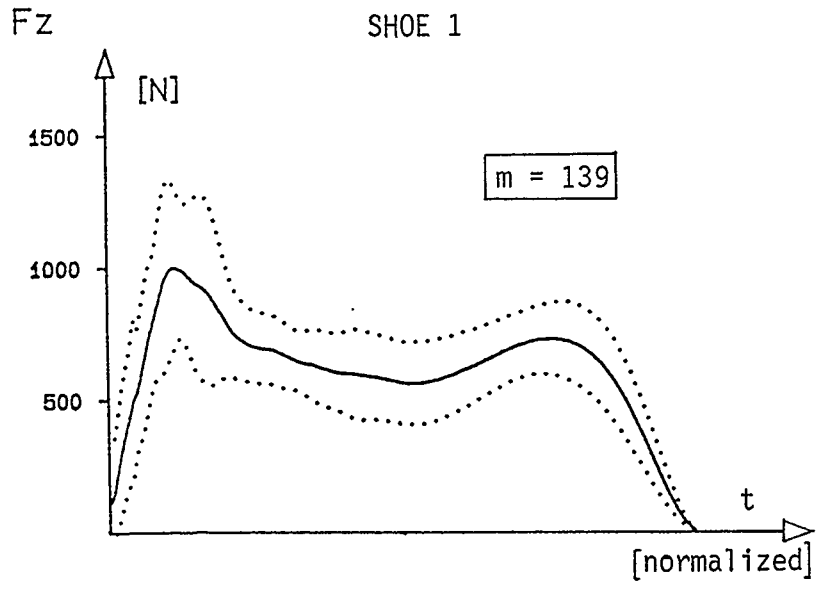

Figure 39. Average vertical force curves and standard deviations for shoe 1 and shoe 2 for hopping sideways (movement 3).

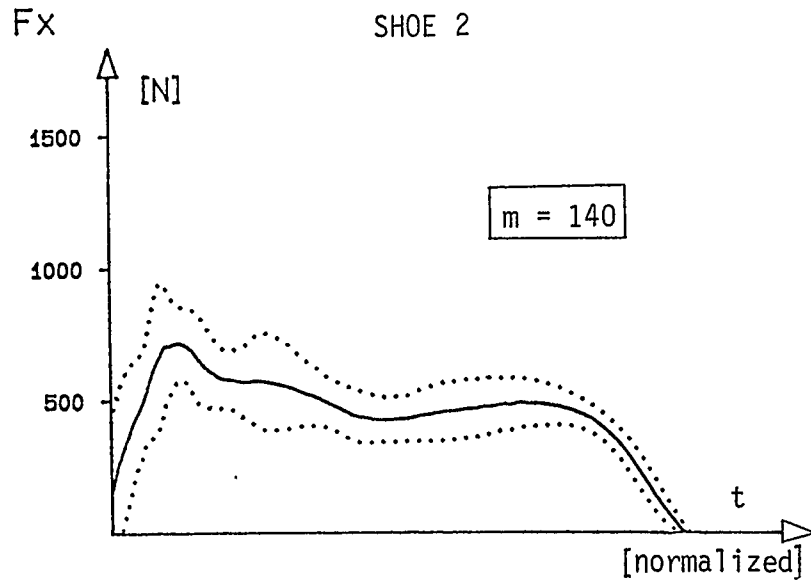
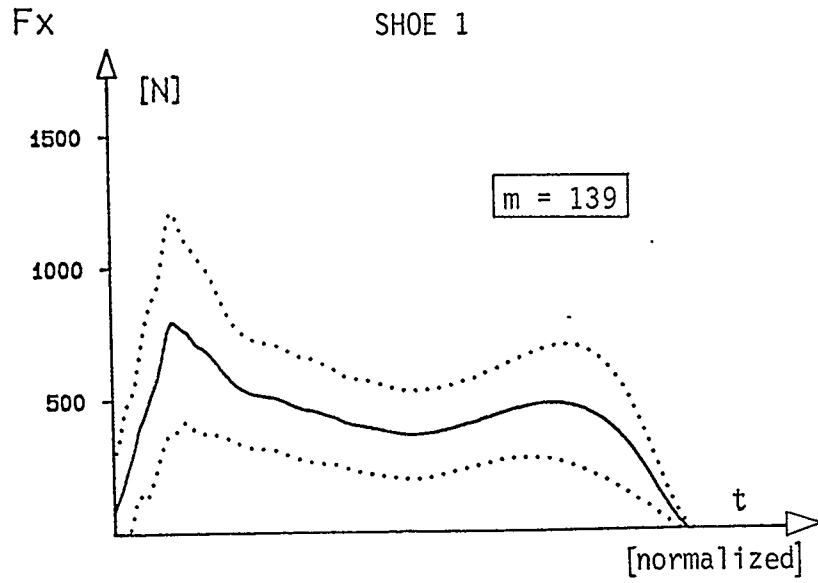

Figure 40. Average lateral force curves and standard deviations for shoe 1 and shoe 2 for hopping sideways (movement 3).

c) Comparison of the results between the groups with pain and without pain

The most important results for the comparison between the groups with pain and without pain are summarized in table 14. The magnitude of the forces do not differ between subjects with pain and subjects without pain.

Table 14. Comparison of the results between players with pain and players without pain for hopping sideways (movement 3). Means and Standard deviations (t-test). Asterisks indicate significant differences.

SHOE	PAIN	m	F _{zmax}	F _{xmax} [N]	t _{max} [ms]	$\Delta\beta_{max}$ [°]	$\Delta\beta_{air}$ [°]	$\Delta\beta_{heel}$ [°]	V _x [m/s]
1	yes	46	1241 (523)	976 (353)	65 (28)	23.0* (4.2)	9.4 (6.3)	13.6* (5.2)	3.6 (1.2)
	no	93	1152 (404)	999 (279)	70 (28)	21.1* (5.4)	10.3 (7.1)	10.8* (3.2)	3.8 (1.3)
2	yes	69	1126 (567)	928 (370)	69 (31)	11.6* (4.4)	6.0 (4.0)	5.6* (5.1)	3.8 (1.4)
	no	71		910 (312)	65 (29)	15.0* (6.3)	7.5 (4.4)	7.5* (5.4)	3.0 (1.0)

Shoe 1: On the average, the group of players reporting discomfort and pain shows more inversion during the first 50 msec of foot contact. About 40% to 55% of the change in the Achilles tendon angle occurs within the first 10 msec between first toe and first heel contact when the heel is still in the air ($\Delta\beta_{air}$). Subjects without pain invert the foot more in

the air than subjects with pain. The pain groups invert more during heel contact (61% of the total inversion for the pain group and 52% for the group without pain). The main difference in inversion of the foot comparing the two groups occurs between the first 10 msec and 50 msec at the time when the heel is on the ground.

Shoe 2: Comparing the two groups playing with shoe 2 it can be seen (fig. 40) that players with pain show in the average less inversion. This is consistent for the first 10 msec when the heel is not yet on the ground as well as for the time interval between 10 and 50 msec when forefoot and heel are touching the ground. Remarkable differences can be seen in the magnitude of the touch-down velocities of the foot. Players with pain had significantly greater lateral velocities, however, it has to be stated that the variations within each group are very large.

The result suggests that this movement is related to the occurrence of pain in tennis. The relevant variable in this case is the achilles tendon angle which describes the inversion of the foot during ground contact. The results suggest that the type of footwear worn and the individual ability to adapt to the shoe contribute to the frequency of occurrence of pain. If a tennis player wearing a soft and flexible shoe is not able to stabilize the foot internally the result can be too much rotational movement in the subtalar joint which seems to be related to the occurrence of pain. If, on the other hand, a shoe is hard and stiff, the shoe can restrict the movement of the ankle too much in the lateral direction which again can be reason for pain. These findings are illustrated in figure 41. An optimal range for the amount can be established. However, this range depends on several factors:

- the geometrical configuration of the foot and leg before first contact
- the velocity of the foot
- the material aspects of the shoe (stability)
- the stabilizing structure of the musculo-skeletal system.

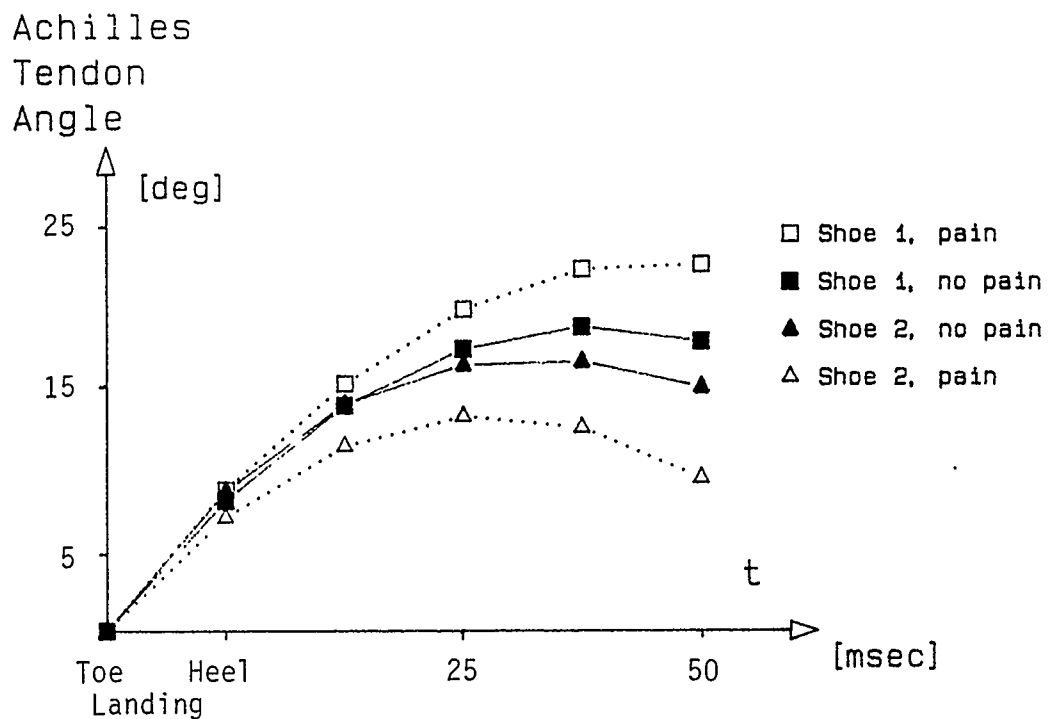

Figure 41. Representation of the effect of inversion of the foot on the occurrence of pain. Average curves (shoe 1, pain: $m=46$; shoe 1, no pain: $m=33$; shoe 2, pain: $m = 69$; shoe 2, no pain, $m=71$).

It may be, but is not expected, that a change of one of more of these factors will result in a shift of this optimal range. The external forces exerted on the lower extremities do not have the importance one would expect with respect to the occurrence of pain in tennis. However, this statement is valid only for the set-up used for the

experiments in the present study. It may well be that a change in the experimental set-up (e.g., increasing velocity of the movement, changes in the geometry of the movement) could make the relationship between external forces and occurrence the of pain in tennis more obvious. Generally it seems that the magnitude of the forces are the cause of problems only if the range of motion of the joints is very restricted (see results for shoe 2).

d) Results for different sites of pain

Table 15. Representation of the results for different sites of pain in movement 3

SHOE	PAIN	N	$F_{x\max}$ [N]	$t_{x\max}$ [ms]	$\Delta\beta_{\max}$ [°]	v_x [m/s]
1	no	47	999	70	21.1	3.8
	knee	1	-	-	-	-
	leg	3	772	65	17.3	3.4
	ankle	2	646	55	29.7	3.8
	heel	5	787	51	25.2	3.5
	arch	10	981	68	19.3	3.3
	forefoot	12	789	69	26.8	3.4
	toes	9	876	50	22.1	3.7
2	no	36	910	65	15.0	3.1
	knee	3	899	75	12.1	3.8
	leg	5	881	69	15.4	3.9
	ankle	5	939	61	11.1	3.7
	heel	9	1036	61	7.8	4.0
	arch	4	1054	77	13.2	4.0
	forefoot	12	846	66	2.4	3.0
	toes	28	1012	69	16.0	3.9

A comparison of the maximum ground reaction forces shows that the lateral force component is smaller for all pain groups wearing shoe 1. However, four of the pain groups wearing shoe 2 have higher lateral forces (ankle, heel, arch and toe pain) compared to the group without pain. In four cases the total amount of inversion during the first 50 msec of foot contact is bigger for the pain groups wearing shoe 1. In 5 cases inversion is smaller for shoe 2. Generally the lateral touch-down velocity is slightly smaller for the pain group with shoe 1 and greater for the group wearing shoe 2, a finding which corresponds with the results of the external forces.

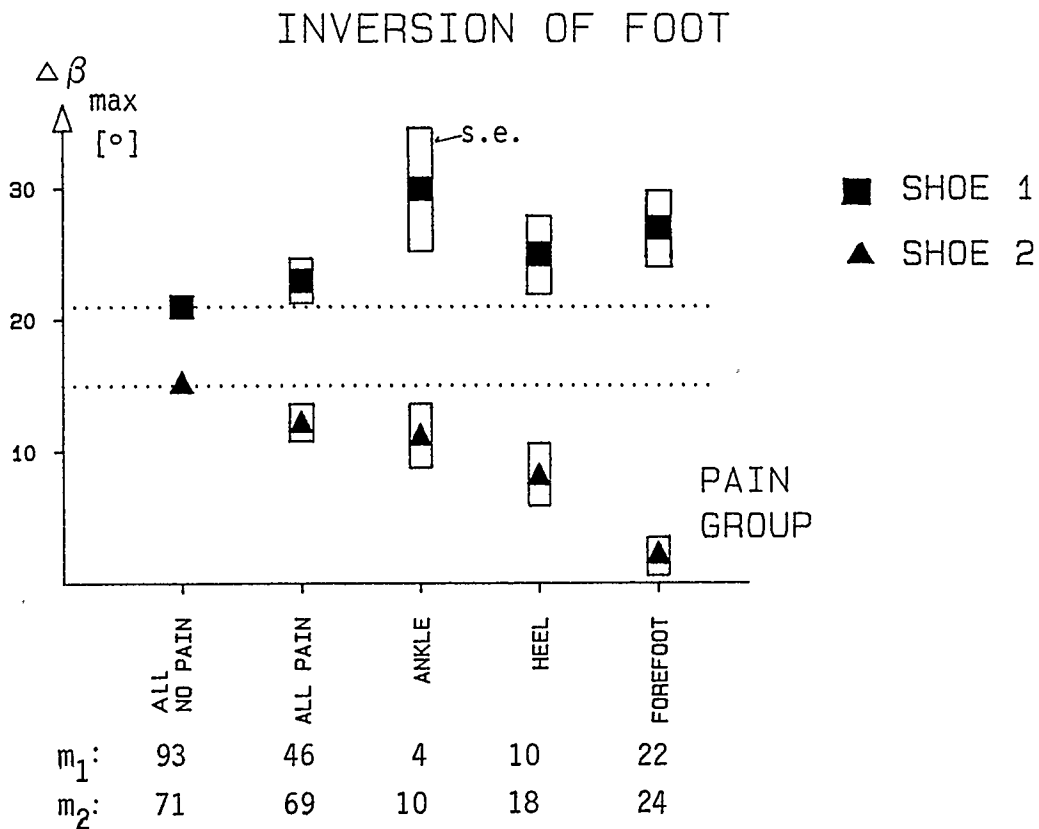

Figure 42. Total inversion of the foot during the first 50 msec of heel contact for different pain groups in movement 3. (Means and standard errors).

It was mentioned before that smaller ground reaction forces are not generally equal to smaller forces in the musculo-skeletal system. The geometry of the foot and leg during ground contact must be considered as well. A difference in the geometry means that different structures of the system are loaded. It can be assumed that the load on the lateral ligaments of the foot and the peroneal muscles and tendons is greater for a high inversion than for a low one. On the other hand, if the inversion of the foot is very small, then the bones and joints must absorb most of these forces. An explanation for this problem can be given with an analytical model which will be introduced in chapter 4.2.5. The influence of inversion on different pain subgroups is represented in figure 42. It is illustrated that the problems connected with inversion occur mainly in the foot (ankle, heel or forefoot pain). The results underline the assumptions mentioned above. Based on these results, a hypothesis could be stated that the degree of inversion while performing this movement is relevant for the occurrence of pain in tennis.

e) Summary of the results for movement 3

The movement, hopping sideways with change of direction (outwards-inwards) seems to be connected with the occurrence of pain in tennis. The most important findings are:

- 1) The construction of the shoe mainly determines the degree of inversion of the foot during the first 50 msec of ground contact. The hard shoe demonstrates more initial inversion during the first 10 msec of contact. The soft and flexible shoe shows greater total inversion.
- 2) The results show differences in the degree of inversion between the groups with pain and the groups without pain. The results are reverse for the two shoes. The soft shoe (shoe 1) can cause problems by allowing the foot too much inversion. The occurrence of pain with shoe 2 may be

connected with too much restriction of the inversion. It is assumed that an optimal range of inversion can be established.

- 3) The vertical and lateral forces measured externally show no differences between the groups with and without pain. However, there is reason to believe that the internal forces may be greater for the groups with pain compared to the non-pain groups (see chapter 4.2.5).

Overall it is felt that this movement can provide more information in connection with the etiology of pain in tennis than the other two movements. Further detailed studies with a systematic variation of the movement and the boundary conditions (e.g., type of shoe) can probably give more information.

4.2.5. Analytical approach for hopping sideways

It was mentioned in the previous chapter that this movement seems to be related to the occurrence of pain in tennis. The results from force and film measurements suggest that too much inversion as well as too little inversion can be causes of pain in the foot. In order to increase the principle understanding of these findings, a simple analytical model was developed.

a) Basic considerations: During the impact and the first 50 msec of ground contact the foot is inverted due to the relatively great moments which are acting on the ankle (fig. 43). Assuming that there is no lateral sliding movement of the foot on the ground, the forces which produce these ankle moments (ground reaction forces) can reach multiples of body weight. In order to prevent the foot from collapsing laterally, different external and internal structures of the system have to act against the forces producing the inversion. The results from the experiments suggest, however, that under given boundary conditions the effect of these structures limiting the lateral

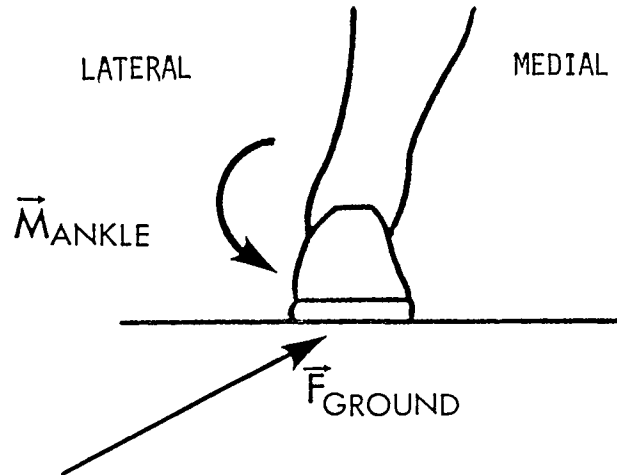

Figure 43. Inversion of foot produced by moments at the ankle.

movements of the ankle can be too big as well as too small. Neither of the two effects is desired since both seem to be related to the occurrence of pain.

One main external factor which limits inversion of the foot is the type of shoe worn. It is evident that a stiff shoe is able to stabilize the foot more effectively than a soft and flexible shoe which can be deformed more easily. The influence of the shoe on the lateral movement of the ankle will therefore be a point of special interest in the following model. The resistant force produced by the shoe will be called the "external resistant" force, \vec{F}_{ER} . The principal internal factors are on one side the passive structures associated with the ankle and subtalar joint. These elements are generally the lateral tarsal ligaments (calcaneofibular, anterior and posterior talofibular, talocalcaneal) which stabilize the joints and limit the movements at

the joints. Other passive structures which can contribute to the lateral stabilization of the foot are other surrounding connective tissues (e.g., peroneal retinaculi). The second type of structure which limits inversion are the main evertor muscles of the foot which consist of the peroneal muscles and the extensor digitorum longus. This type of structure can act passively or actively, depending on the type of the load and the time interval of the loading phase.

b) Assumptions

- 1) The model is developed for two dimensions (frontal plane).
- 2) The calcaneus is considered to be a rigid body with the shape of an ellipsoid.
- 3) The entire inversion is assumed to occur at the subtalar joint.
- 4) The percentage of load which is absorbed by the various structures is not known yet. Although it would be ideal to know the magnitude of the forces in the different elements, it is a very complex problem which cannot be solved with a simple model. It was mentioned before that the goal of this model is to increase the principle understanding. Therefore the internal elements which limit the inversion of the foot are reduced to one passive element with one line of action and one point of application. In the following the force in this element will be called the "internal resistant" force, \vec{F}_{IR} .
- 5) The two measured external force components \vec{F}_x and \vec{F}_z which are of interest in this problem (see fig. 44) show approximately the shape of a sine-wave in the first 3/8 of one period. In a first approximation, therefore, a sine-function can be used in order to describe the time history of the two components of the ground forces. This can be expressed mathematically as:

$$F_x(t) = F_{x\max} \cdot \sin\omega t$$

$$F_z(t) = F_{z\max} \cdot \sin\omega t$$

where: $F_x(t)$: ground reaction force in x-direction (lateral)

$F_z(t)$: ground reaction force in z-direction (vertical)

$F_{x\max}$: maximal lateral ground reaction force at $\tau/4$.

$F_{z\max}$: maximal vertical ground reaction force at $\tau/4$.

τ : time interval of one period

ω : circular frequency

t : variable time

For $t > 3/8\tau$ the forces can be assumed to stay constant with

The assumed ground reaction forces therefore are:

$$F_{x,z}(t) = F_{x,z\max} \cdot \sin\omega t \quad \text{for: } 0 \leq t \leq 3/8$$

$$F_{x,z}(t) = 0.5 \cdot F_{x,z\max} \quad \text{for: } t > 3/8$$

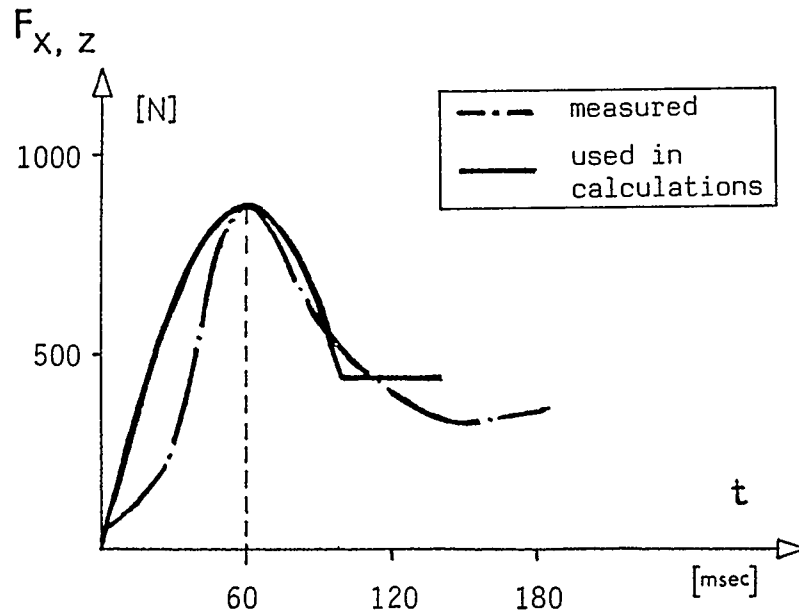

Figure 44. Actual ground reaction force curves and force curves used in calculations

- 6) The geometry of the body (ellipsoid) is known as well as mass and moment of inertia.
- 7) The joint reaction forces are acting in the direction of the leg.
- 8) The weight of the calcaneus can be neglected.
- 9) There is no lateral sliding movement on the ground.

c) Free body diagram: Figure 45 shows the free body diagram of the calcaneus at the moment of impact.

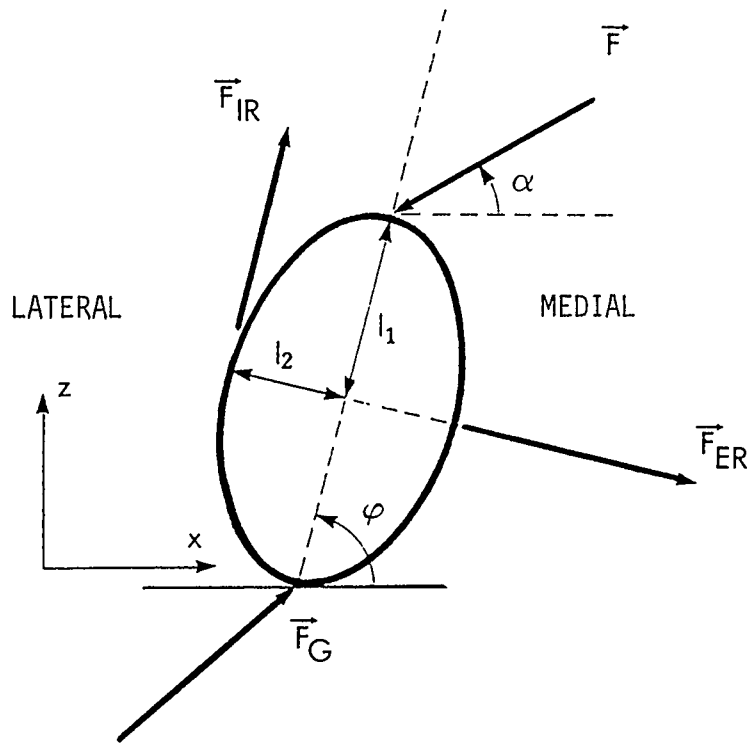

Figure 45. Free body diagram for the calcaneus in the frontal plane

The used symbols are:

- \vec{F}_J : joint reaction force
- \vec{F}_{IR} : reduced force of all internal components limiting inversion of foot
- \vec{F}_{ER} : external resistant force of the shoe
- \vec{F}_G : ground reaction force
- l_1 : long half axis of the ellipsoid
- l_2 : small half axis of the ellipsoid
- I_J : moment of inertia related to the joint

φ : angle between the longitudinal axis of the body and the horizontal

α : angle between the leg and the horizontal

Further simplifications are made:

- F_{ER} is assumed to act perpendicular to the long axis of the body at each time point.
- F_{IR} is considered to act in the direction of the long axis at each time point.

The dynamic behaviour of this model for the first 60 msec can be described with the following equations of motion:

FORCES:

$$m\ddot{x} = F_{Gx} + F_{IRx} + F_{ERx} + F_{Jx} \quad (1)$$

$$m\ddot{z} = F_{Gz} + F_{IRz} + F_{ERz} + F_{Jz} \quad (2)$$

MOMENTS:

$$I_j \ddot{\varphi} = [2F_{Gz} \cdot l_1 \cdot \cos\varphi + F_{IR} \cdot l_2 - 2F_{Gx} \cdot l_1 \cdot \sin\varphi - F_{ER} \cdot l_1]_{y\text{-comp.}} \quad (3)$$

with the boundary conditions:

$$F_{ERx} = k_{ER} \cdot a, \quad \text{where } k_{ER}: \text{"spring" constant of external (shoe) resistant force and } a(t) = x(t) - x(0)$$

$$x(t) = l_1 \cdot \cos\varphi(t)$$

$$z(t) = l_1 \cdot \sin\varphi(t)$$

The known terms in this set of equations are:

- $\alpha(t)$: measured from film
- $\varphi(t)$: measured from film
- $F_{Gx}(t)$: described in assumption 5.
- $F_{Gz}(t)$: described in assumption 5.
- $F_{Gx,zmax}$: the maximal forces were measured with the force platform
- F_{ER} : an estimate for k_{ER} was made for the two shoes based on a simple experiment. the shoes were filled with plaster of paris containing an anchor and the sole was then attached firmly to a fixed surface. A lateral force was then applied to the anchor through a spring gauge until the shoes were deformed 5 cm. The force required to cause these deformations gave an indication of the order of magnitude of the spring constant for the two shoes.

The remaining unknown terms therefore are:

- $\vec{F}_{IR}(t)$
- $\vec{F}_J(t)$

$\|\vec{F}_{IR}(t)\|$ can be obtained from equation (3):

$$F_{IR}(t) = \frac{I_j \ddot{\varphi}(t) + 2l_1 [F_{Gx}(t) \cdot \sin\varphi(t) + F_{ER}(t) - F_{Gz}(t) \cdot \cos\varphi(t)]}{l_2} \quad (4)$$

$F_J(t)$ can be calculated, knowing $F_{IR}(t)$ and using either equation (1) or (2).

With equation (1):

$$F_{Jx}(t) = m\ddot{x}(t) - F_{Gx}(t) - F_{IRx}(t) - F_{ERx}(t) \quad (5)$$

with additional equations:

$$\begin{aligned} F_{IRx}(t) &= F_{IR}(t) \cdot \cos\varphi(t) \\ F_{ERx}(t) &= F_{ER}(t) \cdot \cos[90 - \varphi(t)] \\ F_{Jx}(t) &= F_J(t) \cdot \cos\alpha(t) \end{aligned}$$

The additional equations can be inserted in (5) so $F_J(t)$ can be calculated:

$$F_J(t) = \frac{m\ddot{x}(t) - F_{Gx}(t) - F_{IR}(t) \cdot \cos\varphi(t) - F_{ER}(t) \cdot \cos[90 - \varphi(t)]}{\cos\alpha(t)} \quad (6)$$

The set of equations was solved in an iterative way with the help of a computer model, especially developed for this problem (Appendix E). In a first step actual data from the measurements were used to calculate the time behaviour of the internal forces F_{IR} and F_J for different cases. In a second step a parameter variation was done with the variables: F_G , k_{ER} and φ . This means that just one variable was varied continuously while the others were kept constant. Thus, the general influence of this variable on the magnitude and the principle behaviour of the internal forces could be evaluated.

Special remark: It was mentioned before, that it was not the intention to calculate or estimate accurately the magnitude of the forces. The special goal was to increase the principle understanding and thus to get a better feeling for the results measured in the experiments. This should be considered therefore in the interpretation of the following results.

Assumptions for the numerical calculations:

The mass of the calcaneus was set to be 0.05 kg. 0.03 m was chosen for the long half axis and 0.02 m for the short half axis of the ellipsoid. A value of 1000 N/m was estimated as spring constant for shoe 1 and 2000 N/m for shoe 2. The film data $\alpha(t)$ and $\varphi(t)$ were smoothed with a 3rd order polynomial fit.

d) Results

The internal forces calculated for the mean curves within the first 60 msec of ground contact from film and force data are represented in figure 46. The results from the model demonstrate about 20% higher joint forces (3100 N) for shoe 2 compared to shoe 1 (2500 N). A comparison of the internal resistant forces, however, shows about 25% higher force maxima for shoe 1 (2800 N for shoe 1, 2200 N for shoe 2). The time at which the internal resistant force maxima occur is about the same for both shoes. These findings can be better understood if one considers the experimental results. It has been shown that the inversion of the foot was significantly greater for the group wearing the soft shoe 1 compared to the stiffer shoe 2. This means that the absorption of the kinetic energy of the body in the first 60 msec of foot contact is done in different ways. Little inversion of the foot during this time period means that the main part of the energy has to be absorbed by the bones and joints. The results therefore are the higher forces which are directly transmitted through the joint. As the amount of inversion of the foot increases, more and more of the energy absorption can be overtaken by other structures (e.g., ligaments, muscles, soft tissue). Too much inversion, however, will result in overloading of these structures. Figure 47 shows the principle behaviour of the different internal forces as a function of the total inversion during the first 60 msec of foot contact. It can be seen that the magnitude of the maximal internal resistant forces increases continuously when the inversion increases. The joint forces, however, are big when the inversion at the joint is small.

Calculated Forces

Internal
Resistant
Forces

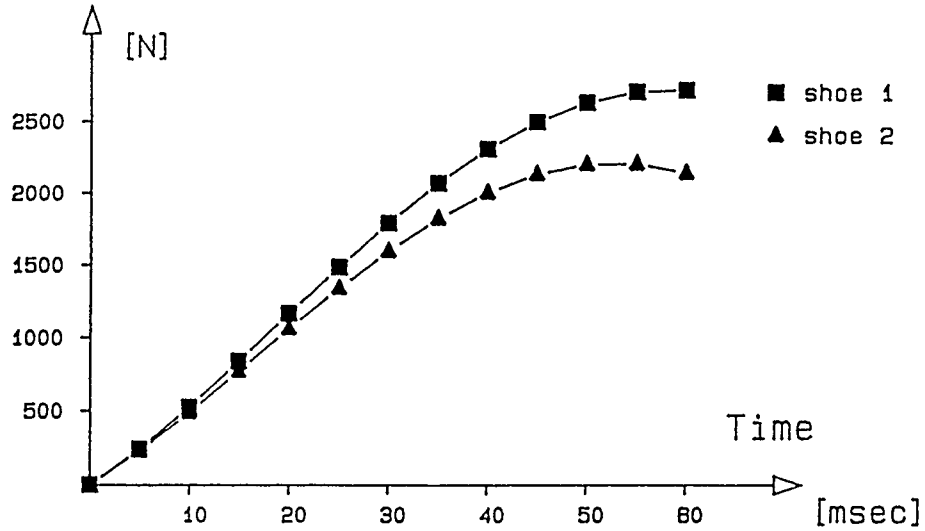

Joint
Forces

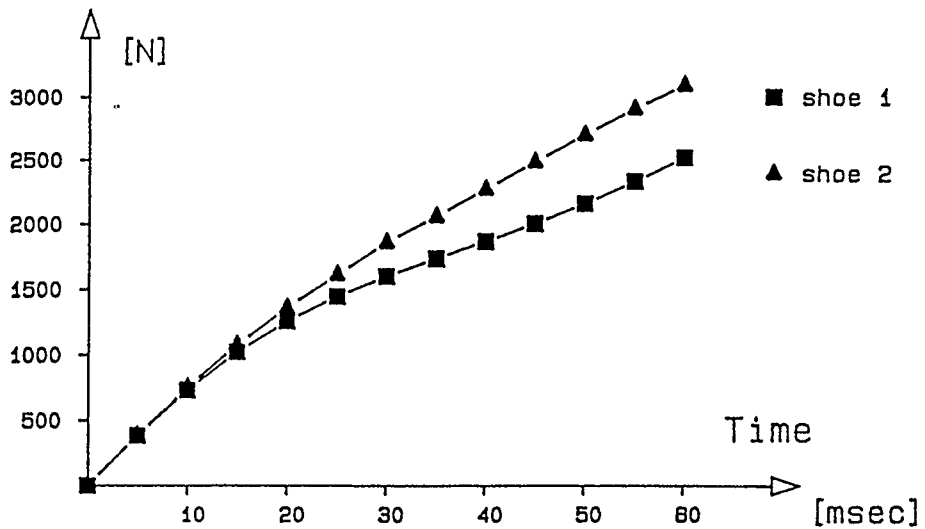

Figure 46. Comparison of the calculated internal forces for the group with shoe 1 (m=139) and the group with shoe 2 (m=140).

Variation: Angle φ

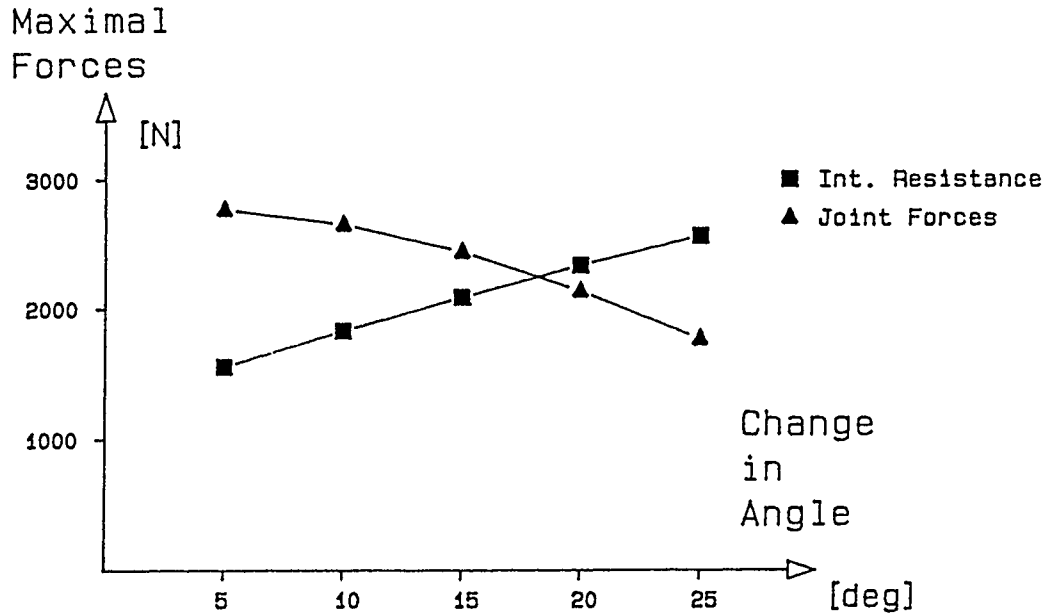
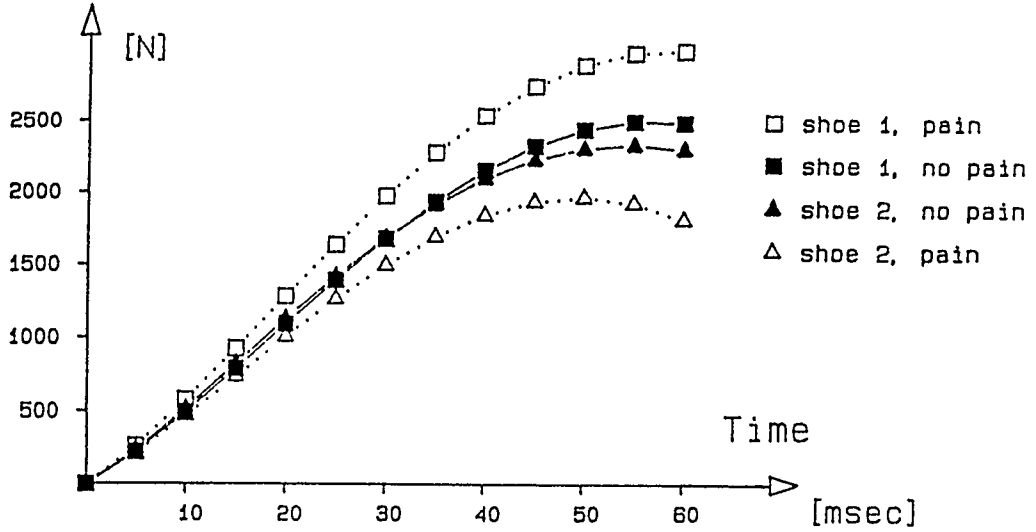

Figure 47. Calculated maximum internal forces for different degrees of inversion

A comparison of the results of the groups with pain and without pain is illustrated in figure 48. The real values of these subgroups for film and force measurements, $\varphi(t)$, $F_{x,zmax}$, τ , were taken and F_{IR} and F_{ER} were calculated. The results underline the findings mentioned above. It can be seen that the internal resistant forces are greatest for the group with pain wearing the soft shoe 1 whereas the joint forces are highest for the group with pain wearing the harder shoe 2.

Calculated Forces

Internal
Resistant
Forces



Joint
Forces

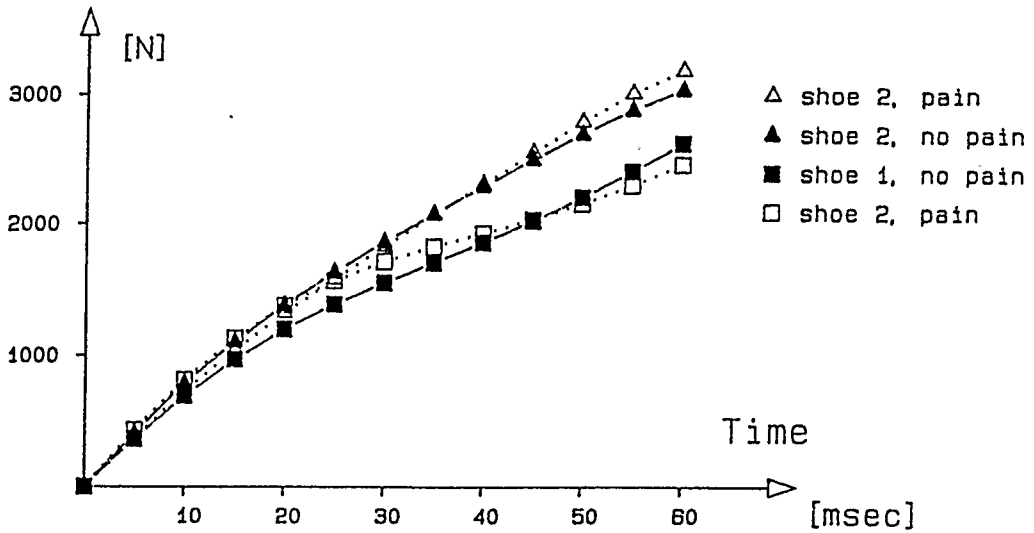

Figure 48. Calculated internal forces for the groups with pain and the groups without pain (Shoe 1, pain: m=46; shoe 1, no pain: m=93; shoe 2, pain: m=69; shoe 2, no pain: m=71).

The influence of the "stiffness" of the shoe was analysed and is illustrated in figure 49. The results show that for a spring constant up to about 10^4 N/m this variable has practically no influence on the magnitude of the internal forces. The reason is that the forces (F_{ER}) for a $k_{ER} < 10^4$ N/m are very small compared to the other forces in the model.

This could mean that the construction of the upper part of a shoe is not very important for this type of movement. This explanation, however, seems not very likely since it was felt that the stiffness of the shoe material does have an influence on the execution of the movement. A second reason for the result could be the fact that the spring constants used in the model, based on a simple test, were

Variation: k shoe 1

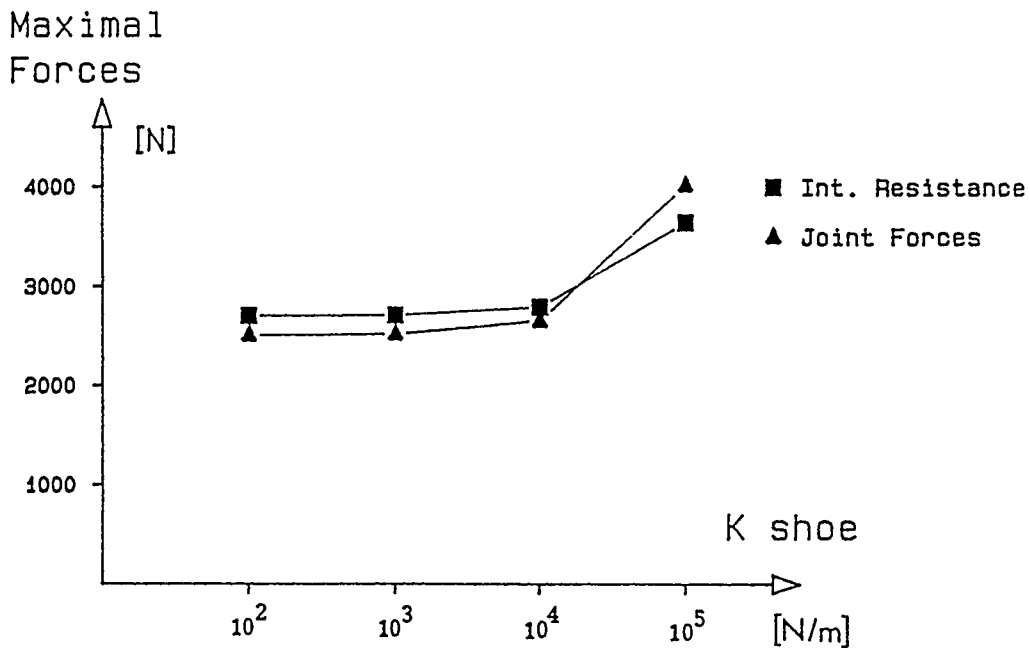

Figure 49. Calculated maximal internal forces as a function of different spring constants k_{ER}

assumed to be too small and are actually in the order of magnitude of 10^4 N/m. The answer to this problem cannot be given at the moment. Further investigations and probably the development of material tests will be necessary to increase the understanding.

e) Summary

The influence of the amount of inversion of the foot on the occurrence of pain in tennis which was indicated by the experimental results could be confirmed using the analytical approach. It seems that part of the foot pain which occurs can be explained with these findings. Probably the most interesting result from the model calculations is that the load on the various structures in the foot, i.e., bones, joints, ligaments, etc., varies greatly with different dynamic behaviour of the test subjects, though a comparison of the measured external forces (ground reaction forces) does not show differences. This means that knowing the external kinetic and kinematic variables is in many cases not sufficient to get the desired information about the load on the musculo-skeletal system. The inclusion of a model, even if it is a very simplified representation of the reality, can increase the understanding of the problem significantly.

4.2.6. Summary of the biomechanical results

Based on the results of the present study, the variables which seem to be connected with the etiology of short-term discomfort and pain in tennis are outlined in table 16.

The results found in the present study suggest three important general factors which influence the lower extremity loading in tennis.

- 1) The shoe influences the type and the magnitude of the stresses exerted to the lower extremities.
- 2) An optimal range for inversion of the foot during sideways movements can be established in order to reduce the frequency of the occurrence of short term pain.
- 3) Certain types of movements can be more related to discomfort and pain than others.

Table 16. Summary of the variables influencing pain in tennis

	DESCRIPTION OF VARIABLE	SYMBOL	DIFFERENCE BETWEEN PAIN(p) NO PAIN(np)	
			SHOE 1	SHOE 2
RUNNING	The frequency of occurrence of impact peak forces in the vertical direction	f_I	p=np	p>np
	The total inversion (supination) during foot contact	$\Delta\beta_{sup}$	p>np	p>np
	The total eversion/inversion during foot contact	$\Delta\beta_{tot}$	p>np	p>np
RUNNING - STOPPING	The maximal a-p shear forces	F_{ymax}	p=np	p>np
	The vertical touch-down velocity of the heel	V_z	p<np	p<np
	The a-p touch-down velocity of the heel	V_y	p>np	p>np
	The knee angle before touch-down	ϵ_0	p<np	p>np
HOPPING SIDEWAYS	The inversion of the foot during the first 50 msec of foot contact	$\Delta\beta_{max}$	p>np	p<np
	The inversion during toe contact	$\Delta\beta_{air}$	p<np	p<np
	The inversion during heel contact	$\Delta\beta_{heel}$	p>np	p<np

The results indicate that the load varies from shoe to shoe. The rather soft and flexible shoe (shoe 1) allows some rotational movement at the various joints of the foot. Thus, the acting external forces can be absorbed over a longer time period. The structures which are loaded during this time period are mainly the associated elements of the joints (ligaments, tendons, muscles). However, the movement in the joints can be excessive and therefore result in overloading of these elements. On the other hand, the hard and stiff shoe (shoe 2) places greater limits on movement at the foot joints. In this case the forces must be absorbed mainly by the bones and the joints. If the joint movements are very small, then the forces in the joints are correspondingly greater and can be cause for discomfort and pain. Human joints are adapted for certain ranges of motion (Isman and Inman, 1969; Lanz and Wachsmuth, 1972; Inman, 1976) and the results of the present study suggest that too much or too little motion in a joint can disturb the equilibrium of force absorption by the various elements.

The results suggest that certain test subjects are able to internally stabilize the joints in the lower extremities even when wearing a shoe which can be deformed quite easily. On the other hand, some players are able to deform a stiff shoe in order to allow some movement to the joints. The findings in the study indicate that fast sideways movements connected with abrupt stops and changes of direction are movements which may be related to occurring discomfort and pain in tennis with respect to the lower extremities. The factors influencing load and stress on the musculo-skeletal system which were investigated in this study were the shoe and the individual dynamic behaviour of the test subjects for three defined movements. The two types of shoes used in the project were different in several construction details (sole, upper, insole). Although the results suggest that the type of shoe influences the occurrence of discomfort and pain in tennis, it is not clear yet which of the shoe variables are the relevant ones. The three selected movements were performed by the test subjects under laboratory conditions. The movements were well defined concerning the element of

the foot making first contact with the ground, the velocity and direction. No field experiments were done in order to analyze the individual dynamic behaviour of the test subjects on the tennis court.

It was a purpose to control as many as possible of the factors which influence the load on the musculo-skeletal system (fig. 2). However, this was not entirely possible. For instance, the fitness level, muscular activity, number of repetitions of a specific movement in a tennis game for each individual test subject was not analyzed. It is to be expected that all these factors influence the occurrence of pain and discomfort in tennis. It is therefore obvious that the results presented in this study show only certain aspects in the investigation of the etiology of discomfort, pain and/or injuries in tennis. In order to get the entire information, all other aspects would have to be analyzed as well.

4.2.7. Statistical results

The results of the statistical tests applied (chi-square, t-test) are indicated in the tables of the previous chapters. The experimental results for the three selected movements showed differences in several variables between the two shoe groups and the groups with pain and without pain. A discriminant analysis was done with those variables in order to find the best predictors which separate the different groups. In order to select those variables that would be included in the discriminant analysis, a Pearson correlation test was conducted. Table 17 shows the final variables used in the discriminant analysis as a consequence of the Pearson correlation. Discriminant analysis was made to distinguish between the following groups:

- a) total group: with pain - without pain
- b) shoe 1: with pain - without pain
- c) shoe 2: with pain - without pain

Table 17. Variables selected for discriminant analysis

MOVEMENT	VARIABLE	EXPLANATION
1	G_{zmax} $\Delta\beta_{sup}$	maximal loading rate (slope) of the vertical force ($grad (F_z)_{max}$) total supination of foot during contact
2	F_{ymax} $\Delta\beta_{30}$	maximal a-p force initial pronation of foot during the first 30 msec of contact
3	F_{xmax} $\Delta\beta_{opt}$	maximal lateral force absolute deviation of the inversion of the foot from an optimal value of 18 degrees

The results from the biomechanical analysis showed that an optimal range of inversion of the foot can be established for lateral movements. Therefore a new variable, $\Delta\beta_{opt}$, was used in the discriminant analysis. This variable indicated the absolute deviation of inversion from an optimal value of 18 degrees. The optimal value is based on the results in chapter 4.2. The new variable therefore can be described as: $\Delta\beta_{opt} = |\beta_{max} - 18^\circ|$.

Special remark

Discriminant analysis usually requires a large number of cases in each group. As a common rule a sample size of at least 10 is necessary for each variable used in the analysis. With this limitation in mind, discriminant analysis was applied to the data for explorative purposes.

a) Total group: with pain - without pain

Discriminant analysis identified, in order of importance, the following variables: $F_{y\max}$ (.68), $F_{x\max}$ (.61), $\Delta\beta_{\text{sup}}$ (.53) and $\Delta\beta_{\text{opt}}$ (.48). The discriminant function had an r^2 value of .35, a Wilks lambda of .88 and a significance level of 0.05. The classification process correctly grouped 60.3% of the "grouped" cases.

The discriminant function suggests that a combination of high a-p forces in forward stopping movements, high lateral forces and increased deviations of the amount of inversion from the optimal range in lateral movements coupled with high supination in running may contribute to pain in the lower extremities.

The magnitude of the lateral forces in movement 3 has not been found to be a relevant variable for the occurrence of pain in the biomechanical analysis. However, this variable was selected by the discriminant analysis. Therefore the relevance of this variable can only be seen in combination with other factors.

b) Shoe 1: pain - no pain

The only variable which qualified for the discriminant analysis was $\Delta\beta_{\text{opt}}$. The r^2 value was .23 and Wilks lambda was .84 and the significance level was 0.12. The values suggest a moderate correlation. Although examination of the histograms shows some overlap, the centroids indicate a good separation of the groups (-0.57 and 1.08). 71.4% of the grouped cases were correctly classified.

The discriminant analysis supports the previously mentioned finding where it was shown that excessive inversion of the foot while performing lateral movements is strongly related to the occurrence of pain in tennis.

c) Shoe 2: pain - no pain

The derived discriminant function included the initial pronation $\Delta\beta_{30}$ (.73), the maximum a-p forces $F_{y\max}$ (.67), the maximum lateral forces $F_{x\max}$ (.61) and the deviation of inversion of the foot from the optimal value $\Delta\beta_{\text{opt}}$ (.60). The r^2 value was .42, Wilks lambda is .83, and the significance level was 0.08. 72.3% of the grouped cases were correctly classified.

The strongest predictors for pain for this shoe were high horizontal shear forces coupled with restriction of inversion of the foot during lateral movements. However, the inclusion of $\Delta\beta_{30}$ in the combination of relevant variables is a new result which was not found in the biomechanical analysis.

d) Summary

Discriminant analysis treatment was applied to the total groups with pain and without pain and the corresponding pain-no pain groups for each shoe. In general, the results were in agreement with the ones found with the biomechanical analysis. The strongest predictors for pain for the total group are high a-p and lateral shear forces while performing stopping movements (forwards and sideways), increased supination in running and either excessive or limited range of inversion of the foot during lateral movements. The deviation of inversion from an optimal range appeared to be the only variable for the soft and flexible shoe. The latter variable, along with the initial pronation during forwards stopping movements, and the horizontal shear forces, were the variables which were selected by the analysis for the harder shoe.

5. GENERAL REMARKS AND CONCLUSIONS

During tennis activity the human musculo-skeletal system is exposed to high loadings while performing a variety of different movements. Each single foot contact results in an exchange of energy between the body and the ground. Part of this energy has to be absorbed by the different structures of the lower extremities, e.g., bones, joints, muscles and tendons, ligaments, fat. Each structure has its material properties and an overloading of the structure may result in more or less severe damage. As a consequence, the tennis player experiences discomfort and pain or even an acute injury.

The goal of the present study was to find variables which can be used to describe the etiology of discomfort, pain or injuries from a biomechanical point of view. The techniques used included the measurements of external forces (ground reaction forces) exerted on the musculo-skeletal system while performing different tennis related movements. Additionally, kinematic variables were measured using high-speed cinematography. Three different movements (running, running-stopping, hopping sideways) which frequently occur during tennis activity were chosen for the experiments.

The measured variables can be subdivided into two main categories: "high frequency" variables and "low frequency" variables. An example of the first category is the impact peak force in heel-toe running. An example for the second category is the change of the achilles tendon angle during a foot contact for the same movement. "High frequency" variables are those which occur in about the first 30 msec of ground contact. This type of variable is influenced by the prehistory of the movement. That means knowing the movement immediately before the measurement one gets information about this variable. It is assumed that this type of variable has long-term effects on the musculo-skeletal system rather than short-term effect. The structures which are mostly involved are the bones and the joints because these elements

represent the rigid part of the body which is more susceptible to this type of variable than other elements. For example, the degenerative destruction of articular cartilage in the knee joint of a marathon runner could be the consequence of a very large number of high frequency compression loadings over several years. Short-term effects are probably the result of "low frequency" loadings with a frequency component which is higher than about 10 Hz. The pull of a hamstring muscle in running, for example, normally occurs during the take-off phase and not at the impact.

Since the present study was designed for a two to three month period, the types of pain assessed belong to the category of the short-term effects. Therefore, it was to be expected that the variables which eventually describe the origin of these types of pain are mostly "low frequency" variables.

Based on the results of the present study, the following conclusions can be made:

1. The study showed that subjects which had an optimal range of inversion in the subtalar joint during a hopping sideways movement were less frequently afflicted with pain than subjects which demonstrated either a very restricted range of inversion or subjects which had an excessive range of inversion. This leads to the formulation of the following hypothesis: The shoe construction from point of view of lateral stability has to allow an optimal range of lateral ankle motion for lateral movements in tennis. It is possible to measure this optimal range for a defined movement.
2. The study showed that the frequency of occurrence of pain was different between the two types of shoes used. Since these shoes were different in many aspects, a detailed information about the relevant variables is not available. However, it is speculated

that the lateral support of the shoe is an important factor in connection with pain.

3. The study suggests that the individual dynamic behaviour of the tennis player is related to the occurrence of pain and injuries.
4. The results suggest that lateral movements are the type of movements which are mostly related to pain and injuries in tennis.

6. SUMMARY

The number of cases of pain and injuries in tennis has drastically increased over the last two decades. However, very little is known about the numerous factors causing the injuries or pain. Most of the statements concerning the etiology of pain in tennis are assumptions or suspicions and the purpose of this project was to study the etiology of pain and injuries in the lower extremities which are caused by playing tennis.

Basic considerations concerning the load on the musculo-skeletal system explain that the load is compounded by the movement performed while playing tennis and by the boundary conditions. Information concerning negative effects of load on the musculo-skeletal system which result in pain and injuries is usually gathered from subjects who already have suffered pain and injuries. The method used in this study was a "præ factum" approach (prospective study), i.e., all the information concerning movement and boundary conditions is collected from healthy subjects at the beginning of the study. After playing tennis for a specified period of time, some subjects were affected by pain and/or injuries. Their results were then compared to the results of the subjects who suffered no pain or injuries.

To understand the etiology of pain in tennis the kinematics of movement and external boundary conditions (two types of shoes with low and high friction coefficients) were studied. In this respect a questionnaire was completed by each subject after each playing session. The description of the movement patterns (biomechanical aspect) was carried out with a Kistler force platform and a Locam II high speed camera. A subject performed three types of movement; running, running-stopping and hopping sideways. The force platform measured the external forces while the high speed film data were used to measure the touch-down angle and velocity of the lower leg, the achilles tendon angle and the rearfoot angle.

Out of the 171 players who completed all the requirements for inclusion in the final analysis, 68 or 40% reported pain. The most common sites for pain were: toes (37 subjects), forefoot (24), heel (14), arch (12) and ankle (7). The foot was the site where pain was most often reported (85%). Pain was frequently reported in the first two playing sessions and less frequently afterwards. Players wearing the harder shoe 2 reported pain more frequently (47.1%) than the players wearing the softer shoe 1 (32.6%).

The biomechanical analysis resulted in consistent findings for the three movements studied. Shoe 1 showed higher lateral forces and greater amount of inversion, while shoe 2 restricted the lateral movement of the ankle (small inversion) which was connected with increased occurrence of pain.

All three movement had variables which showed differences for the pain and no pain groups. Running had four variables which showed differences for the subgroups. The frequency of occurrence of vertical impact peaks and the initial pronation had higher values for the pain group for shoe 2. The total inversion and the total inversion-eversion showed higher values for the pain group for shoe 1. Running- stopping showed for both shoes a higher maximal a-p force, a higher a-p touch-down velocity, a lower vertical touch-down velocity and a smaller knee angle at touch-down for the pain group. Hopping sideways showed optimal ranges for the total inversion (supination) of the foot during the first 50 msec and for the total inversion (supination) during heel contact. In addition, the inversion during toe contact only showed lower values for the pain group for both shoes. It is felt at this point of time that sideways hopping is the movement which provided the best information for the etiology of pain in tennis. The finding of optimal ranges of inversion during that movement is new and may contribute to the understanding of the etiology of pain in tennis.

In this study, high forces were not the primary causative factor in the occurrence of pain. This is probably due to the fact that only short-term influences were assessed with this short-term study. The findings of this investigation were mainly related to the pain associated with wearing new tennis shoes. The results of the present study suggest the assumption that the type of footwear worn and the subject's ability to adapt to the shoe contribute significantly to the occurrence of pain.

7. REFERENCES

- Bates, B.T., Osternig, L.R., and Mason, B. (1978). Lower extremity function during the support phase of running, Biomechanics VI B (edited by Assmussen, E.P. and Joergensen K.) pp. 31-39, Baltimore University Park Press.
- Bates, B.T., Osternig, L.R., Mason, B.R., and James, S.L. (1979). Functional variability of the lower extremity during the support phase of running. Med. Sci. Sport. II, 328-331.
- Bernhang, A.M. (1979). The many causes of tennis elbow. N.Y. State J. Med. 9, 1363-6.
- Biener, K. (1967). Soccer injuries. Schweiz. Z. Sportmed. 15: 121-140.
- Biener, K. and Caluori, P. (1977). Sports accidents of tennis players. Med. Klin, 72 (17):754-757.
- Bonstingl, R.W., Morehouse, C.A., and Niebel, B.W. (1975) Torques developed by different types of shoes on various playing surfaces. Med. Sci. Sports 7(2):127-131.
- Carrol, R. (1981). Tennis elbow: incidence in local league players. Br. J. Sports Med. 4, 250-256.
- Cavanagh, P.R. and Lafortune, M.A. (1980a). Ground reaction forces in distance running, J. Biomechanics, 13, 397-406.
- Cavanagh, P.R. (1981). The running shoe book (edited by Cavanagh, P.R.) pp. 83-89, 259 - 260, Mountain View, California. World Publication.
- Cavanagh, P.R., Williams, K.R., and Clarke, T.E. (1981). A comparison of ground reaction forces during walking barefoot and in shoes. In: Morecki and Fidelius, Biomechanics, vol. VII/B. 151-156, University Park Press, Baltimore.
- Clarke, T.E., Cooper, L., and Clark, D. (1982) Preliminary Testing of tennis shoe traction characteristics. Int. report. Nike Research Laboratory, Exeter, N.H.
- Clarke, T.E., Frederick, E.C., and Cooper, L.B. (1983). The effects of shoe cushioning upon ground reaction forces and footwear. J. Sports Medicine 5, 41-46.

- Clarke, T.E., Frederick, E.C., and Hlavac, H.F. (1983) The effects of a soft orthotics upon rearfoot movement in running. *Journal of the American Academy of Podiatric sports Medicine* 1, 21-23.
- Ekstrand, J. and Gillquist, J. (1983). Soccer injuries and their mechanisms: a prospective study. *Med. Sci. Sports* 15(3):267-270.
- Frederick, E.C., Hagy, J.L., and Mann, R.A. (1981). Prediction of vertical impact force during running. (abstract) *J. Biomechanics*, 14(7):498.
- Froimson, A.E. (1969). Tennis leg. *J. of the American Medical Association*, 209, 415-416.
- Gibbs, R.C. (1973). Tennis toe. *Archives of dermatology* 107, 918.
- Gruchow, H.W. and Pelletier, D. (1979). An epidemiologic study of tennis elbow. *Am. J. Sports Med.* 7, 234-238.
- Gunn, C.C. (1980). Tennis elbow. The surgical treatment of lateral epicondylitis. (letter) *Journal of bone and joint surgery (Boston)* 61(2) 313-314.
- Hess, H. and Hort, W. (1983) Erhoelte Verletzungsgefahr beim Leichtathletik training auf Kunststoffboeden (Increased danger of injuries on artificial track and field sport surfaces). *Sportarzt und Sportmedizin* 12: 282-285.
- Inman, V.T. (1976). *The joints of the ankle.* Williams and Wilkins Co. Baltimore.
- Isman, R.E. and Inman, V.T. (1969). Anthropometric studies of the human foot and ankle. *Bull. Prosth. Res.* 10-11, 97-129.
- Kane, T.E., Hayes, W.C., and Priest, J.D. (1973). Experimental determination of forces exerted in tennis play. (International seminar on biomechanics, 4th. University Park, Penn.
- Kraemer, J. and Schmitz-Beuting, J. (1979). Injuries and problems in tennis. *Deutsche Zeitschrift fuer Sportmedizin* 30(2), 44-46;48, refs.
- Kraus, J.F. and Burg, F.D. (1970). Injury reporting and recording. *JAMA* 213:438-444.
- Kulund, D.M., McCue, F.C., Rockwell, D.A., and Gieck, J.H. (1979). Tennis injuries: prevention and treatment. A review. *American Journal of Sports Medicine* 7(4), 249-253.

- Lanz, T and Wachsmuth, W. (1972). Practical anatomy. Springer Verlag, New York.
- Leonard, T. (1982). How to get the right fit. Tennis 18, 55-60.
- Leonard, T. (1983). How running shoe design can give your game a lift. Tennis 19, 114-122.
- Levisohn, S.E. and Simon, H.B. (1980). How to avoid back problems on court. Tennis 15.
- Michel, H. (1978). Drehbewegungen auf Bodenbelägen (Rotational movements on sport surfaces). Masters thesis in biomechanics. ETH Zurich.
- Nigg, B.M., Eberle, G., Frey, D., Luethi, S., Segesser, B., and Weber, B. (1978). Gait analysis and sport shoe construction. Biomechanics VIA (edited by Assmussen, E.P. and Joergensen, K.) pp. 303-309. Baltimore, University Park Press.
- Nigg, B.M. and Luethi, S. (1980). Bewegungsanalysen beim Laufschuh (Movement analysis for running shoes). Sportwissenschaft, 3, 309-320.
- Nigg, B.M. and Denoth, J. (1980). Sportplatzbeläge (playing surfaces). Zurich, Juris Verlag.
- Nigg, B.M., Luethi, S., Segesser, B., Stacoff, A., Guidon, H., and Schneider, A. (1982a). Sportschuhkorrekturen (Sports shoes support inlays). Z. Orthop. 120, 34-39.
- Nigg, B.M., Denoth, J., Kerr, B., Luethi, S., Smith, D., and Stacoff, A. (1983). Load, sportshoes and playing surfaces. Sport shoes and playing surfaces: Biomechanical Properties. (edited by Frederick, E.C.). Human Kinetics.
- Nigg, B.M., Hawes, M., Luethi, S., Bullard, J., Beauchamp, L., and Fisher, V. (1983). Etiology of pain in tennis. A research report for Nike, Inc. Laboratory for Human Performance Studies. University of Calgary.
- Nirschl, R.P. (1974). Etiology and treatment of tennis elbow. Journal of Sports Medicine 2(6), 308-323.
- Nirschl, R.P. and Sohel, J. (1981). Conservative treatment of tennis elbow. Physician and sportsmedicine 9(6), 43-48;53-54.
- Perlman, M. (1979). Foot ailments can be treated and cured. Tennis USA 42(1).

- Priest, J.D., Braden, V., and Gerberich, S.G. (1980). The elbow and tennis, part 1: an analysis of players with and without pain. *Phys. Sportsmed* 8:81-91. Part II: A study of players with pain. *Phys. Sportsmed* 8:77-85.
- Prokop, L. (1976) Sportmedizinische Probleme der Kunststoffbeläge (Medical sports problems caused by artificial floor surfaces). *Sportstättenbau und Baederaeneagen* 4, 1175-1181.
- Richo, R. (1977). Der Einfluss des Bodenbelages auf den Bewegungsablauf der Beine und des Bewegungsapparates im Tennis (The influence of the surface on the movement pattern of the lower extremities and the musculo-skeletal system in tennis). Masters thesis in Biomechanics, ETH Zurich.
- Roth, H.V. (1973). Tennis toe. *Journal of the American Podiatry Association* 63.
- Segesser, B. (1976). Die Belastung des Bewegungsapparates auf Kunststoffböden (Loading of the human body on artificial surfaces). *Sportstättenbau und Baederaeneagen* 4, 1183-1194.
- Segesser, B. (1978). Die Belastung des menschlichen Bewegungsapparates aus der Sicht des Sportmediziners (Load on the musculo-skeletal system from a medical point of view). *Biomechanische Aspekte zu Sportplatzbelägen*. (edited by Nigg, B.M.) pp. 18-27. Juris Druck und Verlag, Zurich.
- Taborelli, R. (1977). So-called tennis leg. *Minerva medica* 68(6), 4 355-358.
- Von Salis-Soglio, G. (1979). Sport injuries in tennis. *Deutsche Zeitschrift fuer Sportmedizin* 30(8), 244-246;248.

8. APPENDIX

APPENDIX A

PARTICIPANT INFORMATION

1. Approximately 250 participants will be randomly selected from an initial sample of 500 people.
2. At the onset of the study each participant will be given a one hour appointment at the Biomechanics Laboratory (Room 106, Physical Education Building, University of Calgary) for the purpose of anthropometric and biomechanical assessment. Each person will be photographed in a standing position from an anterior, posterior and lateral view. A Kistler force platform and high speed filming will be used to assess walking, running and hopping performances.
3. A questionnaire booklet will be given to each of the participants of the study. The "General Information" will be completed by the interviewer and the "Games Record" will be completed by the participant.
4. An interviewer will be assigned to each participant who will be able to answer any questions regarding the study and who will help the participant complete the essential questionnaires.
5. Each participant will be given a pair of conventional NIKE tennis shoes which must be worn for all tennis games during the period of participation in the study.
6. The participant must play 18 or more games during the six weeks of the study.
7. The participant must answer the "Game Record" questionnaire immediately after each tennis game.
8. If at any time during the study the participant feels any discomfort, pain or injury, he/she must make an appointment for a medical examination by Dr. J. Bullard at the University of Calgary Health Services (284-5765) to assess the extent of the problem. Contact the Biomechanics Laboratory (284-7425) if Health Services cannot be reached.
9. Upon completion of the study the participant must return the tennis shoes and the completed questionnaire booklet to the interviewer. When the participants have successfully completed their obligations to the study, they can select from two conventional models, a pair of NIKE tennis shoes to keep.
10. All personal information (e.g. your weight, age etc.) will remain confidential, only group data will be published.

APPENDIX B

<u>GENERAL INFORMATION</u>		office use
Name _____	Subject Number _____	<input type="checkbox"/> <input type="checkbox"/> <input type="checkbox"/> 1 2 3
Street _____	City _____	
Postal Code _____	Telephone No _____	
	Sex..... male.... <input type="checkbox"/> 1 female.... <input type="checkbox"/> 2	<input type="checkbox"/> 4
	Age (yrs)..... <input type="checkbox"/> <input type="checkbox"/>	<input type="checkbox"/> <input type="checkbox"/> 5 6
	Weight (Kg)..... <input type="checkbox"/> <input type="checkbox"/> <input type="checkbox"/>	<input type="checkbox"/> <input type="checkbox"/> <input type="checkbox"/> 7 8 9
	Height (cm)..... <input type="checkbox"/> <input type="checkbox"/> <input type="checkbox"/>	<input type="checkbox"/> <input type="checkbox"/> <input type="checkbox"/> 10 11 12
1. Skill Level.....	Beginner..... <input type="checkbox"/> 1 Intermediate..... <input type="checkbox"/> 2 Advanced..... <input type="checkbox"/> 3	<input type="checkbox"/> 13
2. To the nearest year, how long have you played tennis regularly?.....	None..... <input type="checkbox"/> 1 1-5 yrs..... <input type="checkbox"/> 2 6 or more yrs..... <input type="checkbox"/> 3	<input type="checkbox"/> 14
3. Average hours per week you play tennis during the playing season.....	None..... <input type="checkbox"/> 1 1-2 hrs..... <input type="checkbox"/> 2 3-4 hrs..... <input type="checkbox"/> 3 4 or more hrs..... <input type="checkbox"/> 4	<input type="checkbox"/> 15
4. What surface do you usually play on during the playing season?.....	None..... <input type="checkbox"/> 1 Clay/Sand..... <input type="checkbox"/> 2 Asphalt/Concrete.. <input type="checkbox"/> 3 Synthetic..... <input type="checkbox"/> 4 Other..... <input type="checkbox"/> 5	<input type="checkbox"/> 16
5. Are you involved in another physical activity that you practice two or more times per week?.....	Yes..... <input type="checkbox"/> 1 No..... <input type="checkbox"/> 2	<input type="checkbox"/> 17
6. Have you ever played in a tennis tournament?	Yes..... <input type="checkbox"/> 1 No..... <input type="checkbox"/> 2	<input type="checkbox"/> 18
7. Do you presently have a sport related injury, pain or discomfort?.....	Yes a) lower body.. <input type="checkbox"/> 1 b) upper body.. <input type="checkbox"/> 2 No..... <input type="checkbox"/> 3	<input type="checkbox"/> 19
8. What is your racket made from?.....	Wood..... <input type="checkbox"/> 1 Metal..... <input type="checkbox"/> 2 Fiberglass..... <input type="checkbox"/> 3 Other..... <input type="checkbox"/> 4	<input type="checkbox"/> 20
9. What kind of strings are in your racket?.....	Gut..... <input type="checkbox"/> 1 Nylon..... <input type="checkbox"/> 2 Don't know..... <input type="checkbox"/> 3	<input type="checkbox"/> 21
10. What size is your racket head?.....	Normal size..... <input type="checkbox"/> 1 Oversize..... <input type="checkbox"/> 2	<input type="checkbox"/> 22

APPENDIX C

<u>GAME RECORD</u>		office use																	
Name _____	Date _____																		
	Subject No.....																		
	Playing Session No.....																		
	Shoe No.....																		
			<table border="1"> <tr><td></td><td>1</td><td>2</td><td>3</td></tr> <tr><td>4</td><td></td><td></td><td>5</td></tr> <tr><td></td><td></td><td></td><td></td></tr> <tr><td></td><td></td><td></td><td>6</td></tr> </table>		1	2	3	4			5								6
	1	2	3																
4			5																
			6																
1. What was the temperature during the game?.....	up to 15°C..... 16-20°C..... 21-25°C..... 26-30°C..... above 30°C.....	<input type="checkbox"/> 1 <input type="checkbox"/> 2 <input type="checkbox"/> 3 <input type="checkbox"/> 4 <input type="checkbox"/> 5	<input type="checkbox"/> 7																
2. What was the weather like?.....	a)..... cloudy..... sunny..... b)..... windy..... calm.....	<input type="checkbox"/> 1 <input type="checkbox"/> 2 <input type="checkbox"/> 1 <input type="checkbox"/> 2	<input type="checkbox"/> 8 <input type="checkbox"/> 9																
3. What type of game did you play?..	a)...recreational..... competitive..... b)..... relaxed..... under pressure..... c)..... singles..... doubles.....	<input type="checkbox"/> 1 <input type="checkbox"/> 2 <input type="checkbox"/> 1 <input type="checkbox"/> 2 <input type="checkbox"/> 1 <input type="checkbox"/> 2	<input type="checkbox"/> 10 <input type="checkbox"/> 11 <input type="checkbox"/> 12																
4. How long did you play?.....	up to 30 mins..... 31-60 mins..... 60 plus mins.....	<input type="checkbox"/> 1 <input type="checkbox"/> 2 <input type="checkbox"/> 3	<input type="checkbox"/> 13																
5. On what type of surface did.... you play?	concrete, asphalt..... clay, sand..... synthetic..... other.....	<input type="checkbox"/> 1 <input type="checkbox"/> 2 <input type="checkbox"/> 3 <input type="checkbox"/> 4	<input type="checkbox"/> 14																
6. What was the playing surface like?.....	clean and dry..... clean and wet..... dry, with dust, dirt, leaves etc..... wet, with dust, dirt, leaves etc.....	<input type="checkbox"/> 1 <input type="checkbox"/> 2 <input type="checkbox"/> 3 <input type="checkbox"/> 4	<input type="checkbox"/> 15																
7. Was the shoe comfortable under today's playing conditions?.....	yes..... no..... Comments _____	<input type="checkbox"/> 1 <input type="checkbox"/> 2	<input type="checkbox"/> 16																
8. Was there excessive perspiration of the feet?..	yes..... no..... Comments _____	<input type="checkbox"/> 1 <input type="checkbox"/> 2	<input type="checkbox"/> 17																

		office use	
9. Did you feel the sole offered.....	too much grip..... too little grip..... the right amount of grip.....	<input type="checkbox"/> 1 <input type="checkbox"/> 2 <input type="checkbox"/> 3	<input type="checkbox"/>
Comments _____			18
10. Under today's playing conditions did you feel that lateral support was.....	too much..... too little..... just right.....	<input type="checkbox"/> 1 <input type="checkbox"/> 2 <input type="checkbox"/> 3	<input type="checkbox"/>
Comments _____			19
11. Did you experience any discomfort, pain or injury?.....	yes..... no.....	<input type="checkbox"/> 1 <input type="checkbox"/> 2	<input type="checkbox"/>
If "no", thank you, you're done. If "yes" please continue and visit Dr. Bullard or contact the Biomechanics Laboratory.			20
12. Which of the listed problems did you experience?	discomfort..... pain..... injury.....	<input type="checkbox"/> 1 <input type="checkbox"/> 2 <input type="checkbox"/> 3	<input type="checkbox"/>
			21
13. Where was the discomfort, pain or injury experienced?	head..... neck..... elbow..... wrist..... hand..... shoulder..... back muscle..... spine..... abdomen..... hip..... front thigh..... back thigh..... knee..... calf..... shin..... achilles tendon..... ankle..... heel..... forefoot..... toes.....	<input type="checkbox"/> 1 <input type="checkbox"/> 2 <input type="checkbox"/> 3 <input type="checkbox"/> 4 <input type="checkbox"/> 5 <input type="checkbox"/> 6 <input type="checkbox"/> 7 <input type="checkbox"/> 8 <input type="checkbox"/> 9 <input type="checkbox"/> 10 <input type="checkbox"/> 11 <input type="checkbox"/> 12 <input type="checkbox"/> 13 <input type="checkbox"/> 14 <input type="checkbox"/> 15 <input type="checkbox"/> 16 <input type="checkbox"/> 17 <input type="checkbox"/> 18 <input type="checkbox"/> 19 <input type="checkbox"/> 20	<input type="checkbox"/>
other a) _____		<input type="checkbox"/> 21	<input type="checkbox"/> 22 23
b) _____		<input type="checkbox"/> 22	<input type="checkbox"/> 24 25
14. When did you notice the discomfort, pain or injury?	during the game..... right after the game..... a few hours after the game..... 1 to 2 days after the game.....	<input type="checkbox"/> 1 <input type="checkbox"/> 2 <input type="checkbox"/> 3 <input type="checkbox"/> 4	<input type="checkbox"/>
			26
15. What caused the discomfort, pain or injury?	don't know..... type of movement..... shoe..... recurring chronic pain..... other _____	<input type="checkbox"/> 1 <input type="checkbox"/> 2 <input type="checkbox"/> 3 <input type="checkbox"/> 4 <input type="checkbox"/> 5	<input type="checkbox"/>
Comment on type of movement causing problems _____			27

MEDICAL ASSESSMENT

Name _____ Date _____

Subject No.....
 Playing Session No.....
 Shoe Number.....

1. ANATOMICAL
 SITE

- | | | | | | | |
|------------------|-------------|--------------------------|---|---------------------|--------------------------|----|
| a) General area: | nail | <input type="checkbox"/> | 1 | lower leg | <input type="checkbox"/> | 6 |
| | toe | <input type="checkbox"/> | 2 | knee | <input type="checkbox"/> | 7 |
| | foot | <input type="checkbox"/> | 3 | upper leg | <input type="checkbox"/> | 8 |
| | ankle | <input type="checkbox"/> | 4 | hip | <input type="checkbox"/> | 9 |
| | spine | <input type="checkbox"/> | 5 | other:..... | <input type="checkbox"/> | 10 |
| b) Element | synovia | <input type="checkbox"/> | 1 | bursa | <input type="checkbox"/> | 7 |
| | meniscus | <input type="checkbox"/> | 2 | articular cartilage | <input type="checkbox"/> | 8 |
| | ligament | <input type="checkbox"/> | 3 | capsule | <input type="checkbox"/> | 9 |
| | tendon | <input type="checkbox"/> | 4 | bone | <input type="checkbox"/> | 10 |
| | cartilage | <input type="checkbox"/> | 5 | muscle | <input type="checkbox"/> | 11 |
| | nerve | <input type="checkbox"/> | 6 | soft tissue | <input type="checkbox"/> | 12 |
| | other:..... | | | | <input type="checkbox"/> | 13 |
| c) Site | anterior | <input type="checkbox"/> | 1 | superior | <input type="checkbox"/> | 1 |
| | posterior | <input type="checkbox"/> | 2 | inferior | <input type="checkbox"/> | 2 |
| | lateral | <input type="checkbox"/> | 1 | right | <input type="checkbox"/> | 1 |
| | medial | <input type="checkbox"/> | 2 | left | <input type="checkbox"/> | 2 |

office use

	1	2	3
	<input type="checkbox"/>	<input type="checkbox"/>	<input type="checkbox"/>
4	<input type="checkbox"/>	<input type="checkbox"/>	5
	<input type="checkbox"/>		
	6		

<input type="checkbox"/>	<input type="checkbox"/>
7	8

	9	10
<input type="checkbox"/>	<input type="checkbox"/>	<input type="checkbox"/>
<input type="checkbox"/>	<input type="checkbox"/>	<input type="checkbox"/>

11 12

<input type="checkbox"/>	<input type="checkbox"/>
13	14

<input type="checkbox"/>	<input type="checkbox"/>
15	16

2. DESCRIPTION OF INJURY	a) sprain (degree)	first second third	<input type="checkbox"/> 1 <input type="checkbox"/> 2 <input type="checkbox"/> 3	<input type="checkbox"/>
				17
	b) strain (degree)	first second third	<input type="checkbox"/> 1 <input type="checkbox"/> 2 <input type="checkbox"/> 3	<input type="checkbox"/>
				18
	c) fracture (degree)	simple compound comminuted	<input type="checkbox"/> 1 <input type="checkbox"/> 2 <input type="checkbox"/> 3	<input type="checkbox"/>
				19
	d) nerve injury	local referred	<input type="checkbox"/> 1 <input type="checkbox"/> 2	<input type="checkbox"/>
			20	
e) soft tissue	blister callus corn other:.....	<input type="checkbox"/> 1 <input type="checkbox"/> 2 <input type="checkbox"/> 3 <input type="checkbox"/> 4	<input type="checkbox"/>	
			21	
f) inflammation		<input type="checkbox"/> 1	<input type="checkbox"/>	
			22	
g) other	<input type="checkbox"/> 1	<input type="checkbox"/>	
			23	

3. TIMING	a) how often	once (sudden)	<input type="checkbox"/>	1	<input type="checkbox"/> 24
		intermittent	<input type="checkbox"/>	2	
		gradual	<input type="checkbox"/>	3	
		constant	<input type="checkbox"/>	4	
		movement related	<input type="checkbox"/>	5	
	b) when	during the game	<input type="checkbox"/>	1	<input type="checkbox"/> 25
		immediately after the game	<input type="checkbox"/>	2	
		few hours after the game	<input type="checkbox"/>	3	
		other:.....	<input type="checkbox"/>	4	
4. Final description of the diagnosis	_____				<input type="checkbox"/> <input type="checkbox"/>
	_____				26 27
5. Comments (how the injury happened etc., if necessary).	_____				<input type="checkbox"/> <input type="checkbox"/>
	_____				28 29
6. Treatment	_____				<input type="checkbox"/> <input type="checkbox"/>
	_____				30 31

SOFTWARE USED IN THE STUDY

1. PDP 11/23 (all software was developed in the Research Centre, Faculty of Physical Education, University of Calgary)

PROGRAM	EXPLANATION	AUTHOR(S)
KISTLR	Collects data from force measurements	Burrett, J. Luethi, S. (1982)
CHECK	Displays codes and raw data. Codes can be corrected.	Burrett, J. (1982)
SELECT) SELEC2) SELEC3) SELEC4)	Convert raw data. Print single trials and means and S.D. for all components of external forces	Burrett, J. Bahlsen, A. Luethi, S. (1982)
PLOTHP	Plots single curves on plotter for visual check	Luethi, S. Burrett, J. (1982)

2. PDP 11/44

Software developed at: Research Centre, Fac. of Phys. Ed., U of Calgary

PROGRAM	EXPLANATION	AUTHOR(S)
GRAPH	Graphics package including plots for - continuous graphs - bar graphs - single and mean curves with S.D.	Unold, E. Burrett, J. (1983)

3. HP 9845B and 9874A

Software was developed in

* Biomechanics Laboratory, ETH Zurich, Switzerland

** Research Centre, Fac. of Phys. Ed., U of Calgary

PROGRAM	EXPLANATION	AUTHOR(S)
SHOES) GENERAL) FILM)	Program packages including: - data collection from digitizer - data conversion - data control - printouts and plots	Unold, E. Luethi, S. (1980)* modified: Luethi, S. Bahlsen, A. (1982)**
MODEL	Computer model (used for analytical approach for movement 3)	Luethi, S. (1983)**
AUSGL	Data smoothing program	Unold, E. Denoth, J. (1980)* Luethi, S. (1982)**