

2012-08-21

Footwear traction and lower extremity non-contact injury

Wannop, John

Wannop, J. (2012). Footwear traction and lower extremity non-contact injury (Doctoral thesis, University of Calgary, Calgary, Canada). Retrieved from <https://prism.ucalgary.ca>. doi:10.11575/PRISM/26204
<http://hdl.handle.net/11023/156>

Downloaded from PRISM Repository, University of Calgary

UNIVERSITY OF CALGARY

Footwear Traction and Lower Extremity Non-Contact Injury

by

John William Wannop

A THESIS

SUBMITTED TO THE FACULTY OF GRADUATE STUDIES
IN PARTIAL FULFILMENT OF THE REQUIREMENTS FOR THE
DEGREE OF DOCTOR OF PHILOSOPHY

FACULTY OF KINESIOLOGY

CALGARY, ALBERTA

August, 2012

© John William Wannop 2012

Abstract

For the past forty years footwear traction has been thought to be one of the causes of non-contact lower extremity injury in sport. Previous studies have shown that rotational traction was associated with ACL injury, however, no studies have determined the relationship between footwear traction, both translational and rotational, and all lower extremity non-contact injuries. Therefore, the purposes of this thesis were to 1) determine if a relationship exists between an athlete's specific footwear traction (both translational and rotational) and lower extremity non-contact injury and 2) determine how independently altering translational and rotational traction affects ankle and knee joint loading.

Over the course of three years, 555 athletes had their footwear traction tested on the actual playing surface; either an artificial or natural grass field. The athletes were followed over each season and any injury that they sustained during a game was recorded by certified athletic therapists on site at the field.

No differences in injury rate were seen between the artificial and natural grass surfaces. A relationship was found between rotational traction and lower extremity non-contact injury, with increases in rotational traction leading to an increase in injury rate. A relationship was also seen between translational traction and injury with the mid-range of translational traction leading to a higher injury rate.

To determine how translational and rotational traction affect injury mechanism, three shoes were constructed that had independent alterations in translational and rotational traction. The footwear conditions consisted of a control shoe, a low rotational traction shoe and a high translational traction shoe. Joint loading was calculated with inverse dynamics on 10 athletes performing a v-cut and an s-cut movement in the three footwear conditions.

The results indicate that both rotational traction as well as translational traction can affect the ankle and knee joint loading during football related movements. Coupled with the results of the injury study, although less clear for translational traction, it is believed that these increases in joint loading (joint moments and angular impulses) in the transverse and frontal plane are one of the possible mechanisms in terms of lower extremity non-contact injury.

Preface

The following three chapters are based on scientific manuscripts:

- Chapter 3 Wannop, J.W., Luo, G., & Stefanyshyn D.J. (2009). Wear Influences Footwear Traction Properties In Canadian High School Football. *Footwear Science*, Vol. 1(3), 121-127.
- Chapter 4 Wannop, J.W. & Stefanyshyn, D.J. (2012). The Effect of Normal Load, Speed and Moisture on Footwear Traction. *Footwear Science*, Vol. 4(1), 37-43.
- Chapter 5 Wannop, J.W., Luo, G., & Stefanyshyn, D.J. (2012). Footwear Traction at Different Areas on Artificial and Natural Grass Fields. *Sports Engineering*, Vol. 15(2), 111-116.

All chapters and subchapters were written in a manuscript-based style. Thus, some chapters may contain redundant information mainly in the “introduction” and the “methods” section when the rationale and methods of the studies were similar.

Acknowledgements

I would like to acknowledge the following people that made the completion of this thesis possible:

My wife, family and other close friends, for all their support and encouragement.

My supervisor, Dr. Darren Stefanyshyn. Thank you for providing me with the opportunity to perform my thesis as well as providing me with the environment to grow personally and professionally.

My supervisory committee. Dr. Ian Wright for always being there to answer any question I may have, as well as Dr. Reed Ferber for providing a different viewpoint to solve problems.

My examining committees for the candidacy exam and thesis defence, Dr. Tannin Schmidt, Dr. Walter Herzog, Dr. Jeff Boyd and Dr. Steve Haake.

Adidas International for providing me with the portable traction tester used in this study.

Lab members Jay, Geng, Eveline, Clau, Blayne, Sean, Glenda, Bryon, Glen, Andrezej for teaching, technical assistance, support as well as bringing life to the lab.

Table of Contents

Approval Page.....	ii
Abstract.....	iii
Preface.....	v
Acknowledgements.....	vi
Table of Contents.....	vii
List of Tables.....	x
List of Figures and Illustrations.....	xi
List of Symbols, Abbreviations and Nomenclature.....	xiv
Chapter One: Introduction.....	1
Chapter Two: Literature Review.....	6
2.1 Lower Extremity Injury in Sport.....	6
2.1.1 American Football Injuries.....	7
2.1.2 Lower Extremity Injuries in American Football.....	8
2.1.3 Calgary Specific Football Injuries.....	9
2.1.4 Causes of Injury in Football.....	9
2.2 Traction.....	10
2.2.1 Translational vs. Rotational Traction.....	11
2.2.2 Traction and Injury.....	14
2.2.2.1 Traction and Joint Loading.....	18
2.3 Surfaces.....	20
2.3.1 Surface Related Injury.....	21
2.3.2 Surface Traction.....	25
Chapter Three:Footwear Traction in Canadian High School Football.....	28
3.1 Introduction.....	28
3.2 Methods.....	30
3.3 Results.....	36
3.4 Discussion.....	38
3.5 Conclusions.....	44
Chapter Four:The Effect of Normal Load, Movement Speed and Moisture on Footwear Traction.....	46
4.1 Introduction.....	46
4.2 Methods.....	47

4.3 Results.....	50
4.4 Discussion.....	54
4.4.1 Normal Load.....	55
4.4.2 Movement Speed.....	56
4.4.3 Surface Moisture.....	57
4.5 Conclusion.....	59
Chapter Five: Footwear Traction at Different Areas on Artificial and Natural Grass Fields	60
5.1 Introduction.....	60
5.2 Methods.....	61
5.3 Results.....	64
5.4 Discussion.....	67
5.5 Conclusions.....	70
Chapter Six: Footwear Traction and Lower Extremity Non-Contact Injury.....	72
6.1 Introduction.....	72
6.2 Methods.....	75
6.3 Results.....	79
6.4 Discussion.....	83
6.4.1 Injury.....	84
6.4.2 Surfaces.....	85
6.4.3 Traction.....	86
6.5 Conclusion.....	90
Chapter Seven: The Effect of Translational and Rotational Footwear Traction on Lower Extremity Joint Loading.....	91
7.1 Introduction.....	91
7.2 Methods.....	93
7.2.1 Traction Testing.....	93
7.2.2 Footwear.....	95
7.2.3 Motion Analysis.....	98
7.2.4 Statistical Analysis.....	100
7.3 Results.....	101
7.4 Discussion.....	106
7.5 Conclusion.....	112
Chapter Eight: Summary and Future Directions.....	113

8.1 Footwear Traction in High School Football	114
8.2 Footwear Traction Testing Conditions	115
8.3 Traction and Lower Extremity Non-Contact Injury	116
8.4 Footwear Traction and Lower Extremity Joint Loading.....	117
8.5 Future Directions	119
8.6 Conclusions	121
References.....	124
Appendix A: Preseason Baseline Questionnaire.....	133
Appendix B: Injury Report Form.....	135
Appendix C: Weekly Exposure Form.....	136

List of Tables

Table 3-1. Within day repeatability of the traction tester (Nike Type G shoe)33

Table 3-2. Between day repeatability of the traction tester (Nike Type G shoe)33

Table 4-1. Regression analysis on natural grass.51

Table 4-2. Regression analysis on artificial turf.51

Table 6-1. Anthropometrics of the 555 athletes.....76

Table 6-2. Breakdown of all non-contact lower extremity injuries.80

Table 6-3. Location of non-contact lower extremity injuries.80

Table 6-4. Number of injuries, game exposures and injury rate on the artificial turf and natural grass surfaces.81

Table 6-5. Number of injuries, exposures and corresponding injury rate when athletes were divided into three equal groups based on their footwear traction.81

Table 6-6. Severity of injury of the three groups [% of total injuries]83

Table 7-1. Traction values of the three test shoes. Values represent the mean of five trials with standard deviation. Bold values represent a significant difference from the control condition.....96

List of Figures and Illustrations

Figure 2-1: Diagram of a sled used to measure footwear traction (Nigg & Yeadon 1987) (top) and a custom made footwear traction measurement system (Wannop et al. 2009) (bottom).....	13
Figure 2-2: Photograph of the swivel disc shoe (Cameron & Davis 1973).....	15
Figure 2-3: Photographs of the a) conventional 7 stud football cleat and b) the ‘soccer type’ shoe (Torg et al. 1974).....	16
Figure 2-4: Photograph of the footwear tested. The edge shoes had higher traction and produced a greater incidence of ACL injury than all other shoes	17
Figure 2-5: Diagram of the different generations of turf (adapted from Livesay et al. 2006).	21
Figure 3-1: Frontal and top view schematic diagram of the portable traction testing machine. The machine had a weight of 1870N.....	31
Figure 3-2: Comparison of the translational coefficient of traction compared when calculated from the force plate data, and the portable traction tester load cell data. Data are a mean of three trials.	34
Figure 3-3: Photographs and grouping of the tested cleats. The 5 and 6 edge group have been combined due to there only being one 6 edge cleat which had similar traction to the 5 edge cleat group.	36
Figure 3-4: Representative sample traces of translational and rotational traction measurements vs. displacement.	37
Figure 3-5: Translational and rotational traction of all shoes on the grass and artificial turf surface. Black horizontal bars represent a significant difference.....	37
Figure 3-6: Translational and rotational traction grouped by cleat type of all tested cleats. Black horizontal bars represent a significant difference.	38
Figure 3-7: Photographs of a) a new shoe and b) a worn shoe.	42
Figure 3-8: Diagram of individual cleats being represented as a hard sphere, plowing through the natural and artificial surface. Adapted from Bhushan (2002).	44
Figure 4-1: Photographs of the shoes tested.	48
Figure 4-2: Effect of normal load on translational (top row) and rotational (bottom row) traction. The left column is traction on the natural grass surface, while the right column is traction on the artificial turf surface.	52
Figure 4-3: Effect of movement speed on translational (top row) and rotational (bottom row) traction. The left column is traction on the natural grass surface, while the right column is traction on the artificial turf surface.	53
Figure 4-4: Effect of surface moisture on translational (top row) and rotational (bottom row) traction. The left column is traction on the natural grass surface, while the right column is traction on the artificial turf surface.	54

Figure 5-1: Photographs of the shoes tested	62
Figure 5-2: Location of the six areas used for traction testing	64
Figure 5-3: Translational and rotational traction of the edge, fin and stud shoe on natural grass at the end of the season along the 20 and 40 yard line.	65
Figure 5-4: Translational and rotational traction of the edge, fin and stud shoe on artificial turf at the end of the season along the 20 and 40 yard line.	66
Figure 5-5: Changes in translational and rotational traction along the 20 and 40 yard line on the natural grass field. Negative values indicate a decrease in traction at the end of the season. Significant differences are indicated with an asterisk.	66
Figure 6-1: Effect of translational (right) and rotational (left) traction on the non-contact, lower extremity injuries per 1000 game exposures. Black horizontal lines represent significant differences.	82
Figure 6-2: Correlation of Translational and rotational traction.	89
Figure 7-1: Photograph of the robot testing machine used to test the translational and rotational traction of the footwear.	94
Figure 7-2: Photographs of the two different types of cleats used: adidas aluminumstollen (left), and F50 Tunit (right).	96
Figure 7-3: Photographs of the three footwear conditions, control (top), low rotation (middle) and high translation (bottom).	97
Figure 7-4: Diagram of the V-cut (left) and S-cut (right).	99
Figure 7-5: Horizontal ground reaction force traces (top row), peak horizontal ground reaction force (middle row) and horizontal ground reaction impulse (bottom row) during the stance phase of the v-cut for the three footwear conditions. Data represent the average values from all subjects, with data being normalized from touchdown to toe off.	101
Figure 7-6: Horizontal ground reaction force traces (top row), peak horizontal ground reaction force (middle row) and horizontal ground reaction impulse (bottom row) during the stance phase of the s-cut for the three footwear conditions. Data represent the average values from all subjects, with data being normalized from touchdown to toe off.	102
Figure 7-7: Ankle joint moment curves (top row), peak ankle joint moment values (middle row) and ankle joint angular impulse during the stance phase of the v-cut for the three footwear conditions. Data represent the average values from all subjects, with data being normalized from touchdown to toe off.	103
Figure 7-8: Ankle joint moment curves (top row), peak ankle joint moment values (middle row) and ankle joint angular impulse during the stance phase of the s-cut for the three footwear conditions. Data represent the average values from all subjects, with data being normalized from touchdown to toe off.	104
Figure 7-9: Knee joint moment curves (top row), peak knee joint moment values (middle row) and knee joint angular impulse during the stance phase of the v-cut for the three	

footwear conditions. Data represent the average values from all subjects, with data being normalized from touchdown to toe off.....105

Figure 7-10: Knee joint moment curves (top row), peak knee joint moment values (middle row) and knee joint angular impulse during the stance phase of the s-cut for the three footwear conditions. Data represent the average values from all subjects, with data being normalized from touchdown to toe off.....106

List of Symbols, Abbreviations and Nomenclature

Symbol	Definition
3D	Three dimensional
ACL	Anterior cruciate ligament
A_L	Load supported area
ANOVA	Analysis of variance
A_p	Penetration area
F	Friction force
Hz	Hertz
Kg	Kilogram
m	Meter
mm	millimeter
N	Normal Force
Nm	Newton meter
°	degree
p	Yield pressure
s	second

Chapter One: Introduction

In Canada, the leading cause of injury in adolescents is sport (King et al. 1998), with as many as 78% of sport injuries being located in the lower extremity (Emery et al. 2005). These include injuries to the knee (e.g. anterior cruciate ligament (ACL), patellar tendiopathy), ankle (e.g. lateral ankle sprains), and thigh (e.g. hamstring injuries).

American Football is one of the most popular sports in high school, being played in more than 14,000 high schools in the United States, with an estimated one million students participating each year (National Federation of State High School Associations 2009). Out of all high school sports, football has the largest overall injury rate (Braun 1999; Powell & Barber-Foss 1999) with over 61% of athletes injured over the course of the season (McLain & Reynolds 1989), with the majority of injuries occurring in the lower extremity (Turbeville et al. 2003). Of these lower extremity injuries the most common site for injuries were in the knee, ankle and thigh (Powell & Barber-Foss 1999; Fong et al. 2007) with over 36% of all football injuries being non-contact in nature (Turbeville et al. 2003).

Although footwear traction has been studied for many years, one of the main difficulties when measuring traction arises from the fact that traction of footwear does not follow the laws of mechanical dry friction, which state: 1) the friction force is directly proportional to the applied load and 2) the friction force is independent of the apparent area of contact of the surfaces. Previous studies have shown that the force opposing motion (friction force) can increase as the normal load is increased (Torg et al. 1974; Bowers & Martin

1975; Nigg 1990; Warren 1996; Livesay et al. 2006), however, some studies have shown no effect (Bonstingl et al. 1975; Schlaepfer et al. 1983; Nigg 1990) or even a decrease (Kuhlman et al. 2010) of the friction force with an increase in normal load. Controversy is also present when measuring footwear friction at different translational and rotational speeds, with the majority of studies concluding that measurement speed has no influence on the friction force (Schlaepfer et al. 1983; Andreasson et al. 1986) however, under close examination it appears as though this relationship is very shoe specific. These conflicting results as well as the fact that measurement of footwear friction does not follow the laws of dry friction is due to the non-uniform surface of shoe soles, coupled with the visco-elastic properties contained within the shoe soles.

For the past forty years footwear traction has been thought to be one of the causes of non-contact lower extremity injury in sports. Studies published as early as the 1970's displayed evidence of a decrease in the incidence and severity of knee injuries when high school players wore 'soccer-type' cleats with moulded soles, rather than the conventional 7-cleat shoes worn at the time (Torg & Quedenfeld 1971). It was believed that the 'soccer-type' cleats had much lower rotational traction, which then led to the decrease in injury rates. In a landmark three year prospective study, Lambson et al., (1996) examined the rotational resistance of modern football cleat designs and the incidence of ACL tears in high school football players. Cleats with an Edge design (longer irregular cleats placed at the peripheral margin of the sole with a number of smaller cleats interiorly) had the highest rotational traction and when compared within footwear of high school athletes, led to a statistically higher number of ACL tears compared with all other shoes. The

major limitation of the study, however, was that the actual surface and shoes were not used for rotational traction measurements; only representative sample surfaces and footwear were used. Additionally the results may not have been as strong as initially thought, as all football shoe models did not follow the trend of greater traction leading to a greater incidence of injury.

In recent years, not much work has followed on the results of Lambson, relating footwear traction to injury. The majority of work has examined rotational traction exclusively, completely ignoring translational traction without much justification. Translational traction provides athletes with the ability to start and stop suddenly as well as to perform certain cutting manoeuvres, which may also place the athlete at risk of foot fixation causing injury. In the past decade new generations of artificial turfs as well as engineered grasses and soils have been developed which no doubt will affect the footwear traction of athletes but no studies have been conducted along the lines of the Lambson study on these new surfaces. Lastly, while these studies indicated that increases in traction may lead to injury, they did not attempt to explain the mechanism involved.

Therefore, the main purposes of this thesis were to:

- 1) Determine the range of traction that is present in Canadian high school football on artificial turf and natural grass surfaces.
- 2) Determine how alterations in testing methods affect measured traction values. Specifically how normal load, testing movement speed, moisture, and testing

location affect both translational and rotational traction on artificial and natural turf.

- 3) Determine if a relationship exists between an athlete's specific footwear traction (translational and rotational) and lower extremity non-contact injury.
- 4) Determine how independently altering translational and rotational traction affects knee and ankle joint moments, in order to investigate the potential injury mechanism for non-contact sport related injuries.

The second chapter of this dissertation is a review of the relevant literature describing studies that have examined lower extremity non-contact injuries, football specific injuries, footwear traction, the link between footwear traction and injury, as well as the effect of different surfaces on both footwear traction and injury.

Chapter 3 addresses the first purpose, by describing the range of traction values that athletes currently use in Canadian high school football both on a natural grass and artificial turf.

Chapter 4 describes the methodology for collecting footwear traction data, thereby addressing the second purpose. The effect of different normal load, movements speed and surface conditions on both translational and rotational traction measurements are described.

Chapter 5 also addresses the second purpose by examining how the testing location on natural grass and artificial turf influence footwear traction measurements.

Chapter 6 addressed the third purpose by analysing individual traction and injury data that were collected over three years on natural grass and artificial turf surfaces and determining the relationship that exists between footwear traction and lower extremity non-contact injury.

Chapter 7 determined how each aspect of footwear traction (translational and rotational) affects the possible injury mechanisms of the knee and ankle, specifically joint loading as measured by inverse dynamics calculated joint moments, addressing the fourth purpose.

Chapter 8 summarizes the findings of the thesis and provides a brief discussion of the investigations.

Chapter Two: Literature Review

2.1 Lower Extremity Injury in Sport

In Canada, the leading cause of injury in adolescents is sport (King et al. 1998), with a large percentage of these injuries being relatively severe, making it the primary cause leading to hospital emergency visits in youth (Gallagher et al. 1984). Of these sport injuries, as much as 78% of all injuries are located in the lower extremity (Emery et al. 2005). These include injuries to the knee (e.g. anterior cruciate ligament (ACL), patellar tendiopathy), ankle (e.g. lateral ankle sprains), and thigh (e.g. hamstring injuries). Studies in Scandinavia found that sport injuries constitute 10-19% of all acute injuries treated in emergency rooms (Bahr et al. 2003) and the most common injuries were to the knee and ankle.

Ankle sprains are the most prevalent musculoskeletal injury that occur in athletes and several studies have noted that sports that require sudden stops and cutting manoeuvres, such as football and basketball cause the highest percentage of these injuries (Yeung et al. 1994; Hosea et al. 2000). It has been shown that the ankle joint accounts for between 15-30% of all reported injuries during sideways movements (Stacoff et al. 1996; Fong et al. 2007) and ankle injuries represent over 22% of all high school athletic injuries with over 81% of these injuries being new injuries (Nelson et al. 2007). Symptoms of ankle injuries can last for months or years, with mechanical instability, intermittent swelling, stiffness, and accumulation of cartilage damage leading to degenerative changes (Struijs & Kerkhoffs 2002) and even osteoarthritis (Valderrabano et al. 2009). One study found residual symptoms in 72% of patients 18 months after the initial sprain (Braun 1999).

Injury to the ACL is a frequent injury of the knee, and the mechanism is by sudden deceleration, cutting or pivoting, hyperextension or hyperflexion, or by a blow to a postero-lateral aspect of the knee (Arendt & Dick 1995). Myklebust et al., (1997, 1998) reported that the highest incidence of ACL injuries were recorded in adolescents playing pivoting sports (i.e. basketball, football). The ACL provides postero-lateral rotary stability of the tibiofemoral joint with instability of the ACL leading to buckling when the athlete tries to cut or pivot (Arendt & Dick 1995). ACL injuries greatly increase the risk of early osteoarthritis and it is expected that nearly all injured individuals will suffer from osteoarthritis within 15-20 years of injury (Myklebust & Bahr 2005).

Injuries in sport are generally termed as either contact, resulting from contact with another player or non-contact where the injury occurs without contact with another player. It has been long believed that one of the major causes of non-contact injury is related to the shoe-surface interaction (Torg et al. 1974; Lambson et al. 1996; Pasanen et al. 2008). When examining injuries across all sports, 58% of injuries were found to be due to contact, while up to 36.8% of injuries were thought to be non-contact (Turbeville et al. 2003; Hootman et al. 2007).

2.1.1 American Football Injuries

American Football is one of the most popular sports in high school, being played in more than 14,000 high schools in the United States, with an estimated one million students participating in high school football each year (National Federation of State High School Associations 2009). Due to the nature of American football, specifically the high impact

collisions that result from gameplay, it is estimated that of these one million athletes that participate approximately 600,000 injuries will occur each year, with a large percentage of these injuries being seen in emergency rooms (Burt & Overpeck 2001). Out of all high school sports, football has the largest overall injury rates (Braun 1999; Powell & Barber-Foss 1999) with over 61% of athletes being injured over the course of the season (McLain & Reynolds 1989), with these injuries being moderate in nature leading to an average of 6.7 days of activity being lost per injury (McLain & Reynolds 1989).

2.1.2 Lower Extremity Injuries in American Football

Football is a high contact sport and has the highest injury rates of all sports in high school (Hootman et al. 2007) with the majority of all injuries (62%) occurring in the lower extremity (Turbeville et al. 2003). Of these lower extremity injuries the most common site for injuries were at the knee, ankle and thigh (Powell & Barber-Foss 1999; Fong et al. 2007), with the knee resulting in the greatest injury requiring surgery (59.4% of all football related surgeries) (Powell & Barber-Foss 1999). In football, ankle injuries can represent over 24% of all high school injuries (Nelson et al. 2007) with ankle injuries representing as much as 76% of all football related injuries (Garrick & Requa 1988). The most common injury to the ankle has been shown to be an inversion sprain accounting for up to 94% of all ankle injuries (Powell & Barber-Foss 1999; Fong et al. 2007). These injuries are usually not recurrent in nature, with 90% of all football injuries being new injuries (Powell & Barber-Foss 1999). The majority of injuries are sustained by football positions that involve a large amount of maximal effort cutting and pivoting movements, with running backs (26.4%) and wide receivers (11.6%) being the positions most likely

of sustaining an injury (Nelson et al. 2007). Due to these cutting movements it is of no surprise that even though football is a high impact, contact sport, over 36% of all injuries are non-contact in nature (Turbeville et al. 2003).

2.1.3 Calgary Specific Football Injuries

While most of the literature provides data from studies on football conducted in the United States of America, some literature exists regarding injuries in Calgary area high schools. Although the core aspects of the game are the same, there are subtle differences which exist, mainly regarding some rules as well as the size of the playing surface. Football is less popular in Canada having the third highest high school participation rate in Calgary at 24% (behind both basketball and hockey) (Emery et al. 2006). Similarities in the division of injuries were seen with 66% of injuries found to be due to direct contact with another player (Emery et al. 2006). The most common injuries were ligament sprains (24.8%), contusion (16.3%), concussion (11.3%), broken bone (12.1%), muscle strain (8.5%), dislocation (16.3%), and swelling/inflammation (2.8%) (Emery et al. 2006). The injury rate for Calgary football was found to be 38 injuries/100 participants/year.

2.1.4 Causes of Injury in Football

It is important to note that there are many intrinsic and extrinsic variables at play in football injuries. Athletes with a higher percentage of body fat and a higher body mass index have been connected with an increased risk of lower extremity injury (Gómez et al. 1998). As well an increased risk of injury has been associated with increased playing

experience (Turbeville et al. 2003) and grade level (Ramirez et al. 2006), however, this may be biased by the fact that older athletes usually have more playing time in addition to the likelihood that smaller, weaker athletes may have dropped out. Other studies have also shown that psychological factors can have an effect on injury, with athletes who incurred negative life change measures resulting in an increased risk of injury (Gunnore et al. 2001). It should also be noted that injuries in football are much more common in game competition than in practice (as much as 7-10x) (Powell & Schootman 1992; Turbeville et al. 2003; Ramirez et al. 2006).

There is a phenomenon known as the 'early season injury bias' that has been reported in the literature specifically during the fall season, indicating that athletes are at a greater risk of injury at the start of the season, and that the risk of injury decreases as the season progresses (Bramwell et al. 1972). At the current time it is not known whether this early season bias is caused by de-conditioning of the athlete, a change in the ground hardness causing a change in footwear traction or some other aspect (Culpepper & Niemann 1983).

2.2 Traction

Although footwear traction has been studied for many years, one of the main difficulties when measuring traction arises from the fact that traction of footwear does not follow the laws of mechanical dry friction, making comparisons between studies difficult. Dry friction occurs when two surfaces in contact move relative to one another, with Amonton's laws governing the relationship that exists between the surfaces. Amonton's laws state: 1) the friction force is directly proportional to the applied load and 2) the

friction force is independent of the apparent area of contact of the surfaces. Previous studies have shown that the force opposing motion (friction force) can increase as the normal load is increased (Torg et al. 1974; Bowers & Martin 1975; Nigg 1990; Warren 1996; Livesay et al. 2006), however, some studies have shown no effect (Bonstingl et al. 1975; Schlaepfer et al. 1983; Nigg 1990) or even a decrease (Kuhlman et al. 2010) of the friction force with an increase in normal load. Controversy is also present when measuring footwear friction at different translational and rotational speeds, with the majority of studies concluding that measurement speed has no influence on the friction force (Schlaepfer et al. 1983; Andreasson et al. 1986) however, under close examination it appears as though this relationship is very shoe specific. These conflicting results as well as the fact that measurement of footwear friction does not follow Amonton's laws is due to the non-uniform surface of shoe soles, coupled with the visco-elastic properties contained within the shoe soles; therefore, in this thesis footwear friction will be termed footwear traction.

2.2.1 Translational vs. Rotational Traction

Footwear traction is a property of both the shoe and surface being tested and it is typically broken into two components: translational traction and rotational traction. Translational traction is usually defined as a coefficient calculated by the ratio of force along the direction of movement to the force normal to the shoe-surface interface. Rotational traction on the other hand, is described using the peak moment of rotation with respect to the centre of pressure (Nigg & Yeadon 1987) which refers to rotation of the foot around a point of contact on the shoe sole (Frederick 1986). Translational traction is

thought to be necessary for athletes to run quickly, start and stop while rotational traction is important for cutting, pivoting and rapid changes in direction.

There are many different methods by which researchers have measured footwear traction. In terms of translational traction researchers have utilized simple drag tests, which measure the force opposing motion (traction force), while the shoe is slid across a surface under a given normal load. The drag tests can be conducted using a sled (Stanitski et al. 1974; Bowers & Martin 1975; Schlaepfer et al. 1983) or other custom made device (Torg et al. 1974; Torg et al. 1996; Lambson et al. 1996; Villwock et al. 2009a; Wannop et al. 2009; Kuhlman et al. 2010; Wannop et al. 2010) (Figure 2-1), with the whole shoe attached to a prosthetic foot or shoe last (Wannop et al. 2009; Kuhlman et al. 2010; Wannop et al. 2010) or only parts of the shoe or cleats attached to a disc (Livesay et al. 2006; Severn et al. 2010) in contact with the surface. Other methods to measure translational traction have included pendulum devices (Bonstingl et al., 1975; Van Gheluwe et al. 1983), as well as force plates measuring vertical and horizontal forces while an athlete performs various athletic movements (Nigg et al. 2009). Rotational traction is measured by enabling the sliding mechanisms to be locked and allowing the shoe to rotate about a fixed axis. The moment opposing this rotation is determined using a load cell (Andreasson et al. 1986; Heidt et al. 1996; Villwock et al. 2009a; Wannop et al. 2009; Kuhlman et al. 2010; Wannop et al. 2010) or torque wrench (Torg et al. 1974; Lambson et al. 1996; Torg et al. 1996). The free moments from force plates have also been used with athletes performing sport specific movements (Nigg et al. 2009).

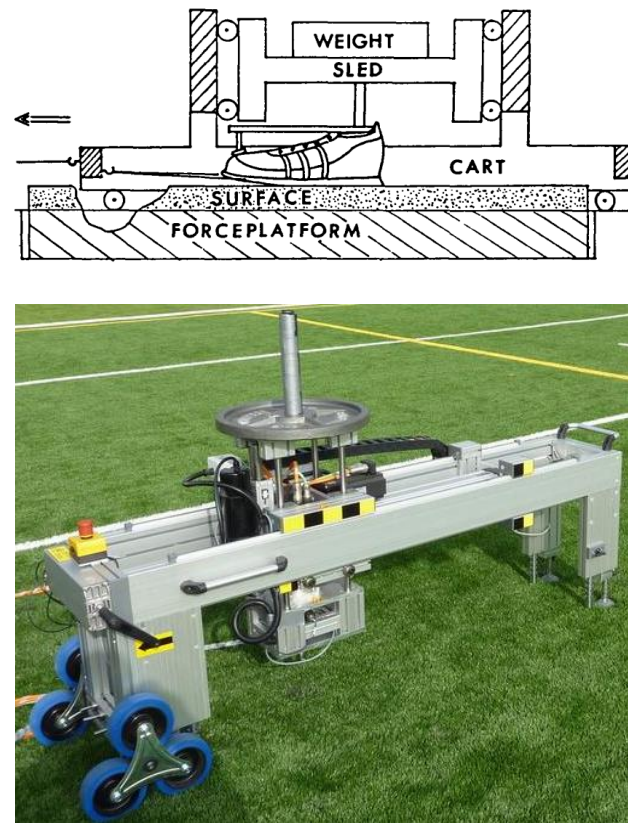

Figure 2-1: Diagram of a sled used to measure footwear traction (Nigg & Yeadon 1987) (top) and a custom made footwear traction measurement system (Wannop et al. 2009) (bottom).

Both translational and rotational traction measurements are influenced by a wealth of factors including normal load (Torg et al. 1974; Bonstingl et al. 1975; Bowers & Martin 1975; Schlaepfer et al. 1983; Nigg 1990; Warren 1996; Livesay et al. 2006; Kuhlman et al. 2010), speed of movement (Schlaepfer et al. 1983; Andreasson et al. 1986), temperature during testing (Torg et al. 1996), as well as the material and pattern of the shoe sole (Frederick 1986). Translational and rotational traction are somewhat connected as an increase in one component, usually results in an increase in the other (Wannop et al. 2010). Although previous authors have suggested that there is no correlation between

translational and rotational traction (Nigg 1986; Nigg & Yeadon 1987) these authors were comparing mechanical translational traction tests with subject rotational traction tests. Mechanical and subject traction tests have very different loading conditions as well as test movements and, therefore, would be expected to provide different results. Subject tests are much more variable and it has been shown that subjects will adjust their kinematics in order to keep their rotational traction below 25Nm (Nigg 1986).

2.2.2 Traction and Injury

For the past forty years footwear traction has been thought to be one of the causes of non-contact lower extremity injury in sports. Foot fixation was first thought to be affiliated with injury in 1969, when a study by Hanley (1969) displayed that a significant decrease in knee and ankle injuries resulted in varsity football players by removing the heel cleats from typical football shoes and replacing them with a three inch diameter heel disc. Subsequent studies attributed injuries to not only the heel cleats but also the forefoot cleats, with a reduction of the size and shape of the forefoot cleats causing a reduction of lower extremity injury (Nedwidek 1969). The major flaw of these studies is the fact that they never actually measured the footwear traction, but it was believed that these alterations to the footwear caused a reduction in traction, which in turn led to a reduction in lower extremity injury.

In 1973, further work looked at the relationship between traction and injury, with the work focused specifically on rotational traction (Cameron & Davis 1973). The study conducted an intervention by implementing a swivel disc shoe to high school football

athletes. The swivel disc shoe replaced the typical forefoot cleats with a cleated turntable, which provided resistance to rotation of at least 10Nm (the exact resistance changed depending on the normal load) after which the turntable was free to rotate. The heel cleats were also replaced with a rigid, plastic, heel disc (Figure 2-2). The study measured the amount of injury between high school athletes who wore the swivel shoe (466 athletes) and a control shoe (2373 athletes) as well as conducted performance measurements of a subset of athletes performing various agility drills wearing the two shoes. The results of the study showed no significant difference in performance between the shoe conditions, however a reduction of injury were seen in the group of athletes wearing the swivel shoe (5.14% of the swivel shoe athletes were injured, compared to 15.68% of the control shoe athletes). While the results of the study appear positive, failure to define and classify the degree of injury, including exposure rates or subject their results to statistical analysis largely limits the results of the study. Again, like other studies at the time, the difference in traction between the two shoes was not measured.



Figure 2-2: Photograph of the swivel disc shoe (Cameron & Davis 1973).

Work by Torg et al. 1974 was the first study to quantify the traction of footwear and combine these results with a previous injury study, in order to gain further insight into the relationship between footwear traction and injury. Torg first observed a decrease in the incidence and severity of knee injuries as well as the number of injuries requiring surgery when high school players wore ‘soccer- type’ cleats with moulded soles, rather than the conventional 7-cleat shoes worn at the time (Torg & Quedenfeld 1971) (Figure 2-3). The authors followed this study by measuring the rotational traction of the ‘soccer-type’ cleat and the typical football shoe, among other shoe models worn at the time. The results displayed that the conventional football shoe had higher rotational traction further strengthening the link between footwear traction and lower extremity injury.

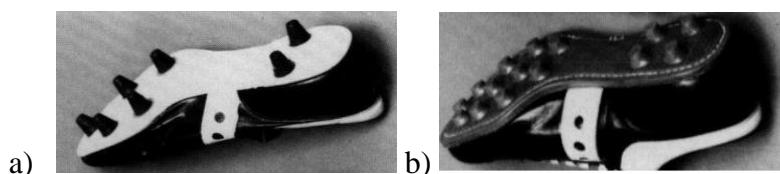

Figure 2-3: Photographs of the a) conventional 7 stud football cleat and b) the ‘soccer type’ shoe (Torg et al. 1974).

In a landmark three year prospective study, Lambson et al. (1996) examined the rotational resistance of modern football cleat design and the incidence of ACL tears in high school football players. Cleats with an Edge design (longer irregular cleats placed at the peripheral margin of the sole with a number of smaller pointed cleats interiorly) (Figure 2-4) had the highest rotational traction and when compared within footwear of high school athletes, led to a statistically higher number of ACL tears compared with all other shoes. While this study was the first to examine the link between footwear traction

and injury prospectively, it still possessed some limitations. The major limitation was that the actual surface and shoes was not used for rotational traction measurements only representative sample surfaces and footwear were used. Additionally, the results may not have been as strong as initially thought, as all football shoe models did not follow the trend of greater traction leading to a greater incidence of injury. Examining the results in detail, the screw-in cleat design had the second lowest rotational traction values, almost 18% lower than the edge design, yet the injury rate among its athletes was similar to that of the edge cleat group (0.015 compared to 0.017, which is the ratio of the number of injuries compared to the total number of participants). While there was a much smaller number of athletes who wore the screw-in shoe compared to the edge shoe (66 compared to 2231), the large injury rate prevalent with this shoe cannot be ignored. Lastly, the study only looked at injuries to the ACL, which may be the most expensive and traumatic non-contact injury, however, ankle injuries are deemed to be the most prevalent.

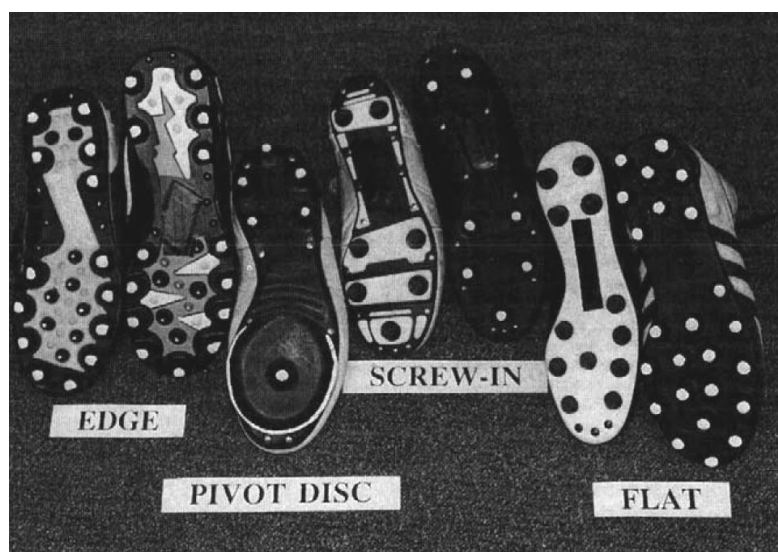

Figure 2-4: Photograph of the footwear tested. The edge shoes had higher traction and produced a greater incidence of ACL injury than all other shoes (Lambson et al., 1996).

In recent years, not much work has followed on the results of Lambson, relating to footwear traction and injury. It is still widely thought that rotational traction is the important component of traction in terms of injury. The majority of work has examined rotational traction exclusively, completely ignoring translational traction without much justification. Translational traction provides athletes with the ability to start and stop suddenly as well as to perform certain cutting manoeuvres, which may also place the athlete at risk of foot fixation causing injury. While the study of Lambson indicated that high traction may lead to injury, they did not indicate how much traction was too much or what amount of rotational traction is safest. In the past decade new generations of artificial turf as well as engineered grasses and soils have been developed which will likely affect the footwear traction of athletes but no studies have been conducted along the lines of Lambson's study on these new surfaces. Lastly, while these studies indicated that increases in traction may lead to injury, they did not attempt to explain the mechanism involved. Future studies should be conducted answering these questions.

2.2.2.1 Traction and Joint Loading

While previous studies have determined that footwear traction can lead to injury, there has not been abundant research as to the mechanism of increasing traction leading to an increasing risk of injury.

One of the thoughts regarding how increases in footwear traction can affect injury is the thought that as traction is increased, the joint loading at the knee and ankle will also be increased. A study conducted in 2007 examined the knee loading while performing

various cutting manoeuvres using modern studded as well as bladed soccer boots (Kaila 2007). The study recruited 15 professional soccer players and collected kinematic and kinetic data while they performed cutting manoeuvres on an artificial turf surface (Field turf). The authors concluded that the different soccer boots caused no change in the knee joint loading during the cutting movements. This study has some issues, mainly the fact that the traction of the different boots was never measured. The two boots, although different in styles and stud configuration may have had similar traction values explaining the lack of differences in joint loading. As well the authors tested four different boot styles and had each athlete perform three different movements. Examining the results of the study in more detail, it appears that the boots did have substantial effects on the joint loading of the knee with differences in valgus loading between two boots being 15.74Nm and 11.56Nm for straight running, 26.92Nm compared to 23.76Nm for the 30° cut and 27.62Nm compared to 18.86Nm for the 60° cut. There appears to be a difference between joint loading when different footwear was utilized, however, the author utilized a correction for multiple comparisons, so although there were no significant differences present, there appears to be an influence of the footwear on joint loading.

A similar study was conducted in 2010 in which two shoes that had quantifiable differences in both their translational and rotational traction were used. Athletes were brought into the lab and performed v-cuts at maximal effort with the different footwear, while their kinematics and kinetics were measured (Wannop et al. 2010). Performing movements in the high traction shoe led to significant increases in both ankle and knee joint loading. This increase in traction did not result in any increase in performance. This

study indicated that increases in footwear traction can lead to increases in joint loading, which may in turn lead to an increased risk of injury. As well it indicated that a reduction in traction may be achieved without a loss in performance. One major limitation of the study, however, has to do with the fact that the high traction shoe was high in both translational and rotational traction, therefore, making it impossible to determine the effect each component of traction had on joint loading.

2.3 Surfaces

Footwear traction depends on the interface between the shoe and surface. Over the years alterations and advancements to footwear have been accomplished, however, perhaps the largest changes over the past decade have occurred in relation to the artificial surface used in sport.

Artificial turf was first used as an alternative to natural turf in 1966, with the first major installation being Texas in the Astrodome. These early turfs are known as first generation, and were made from fibres (usually nylon) densely packed with no shockpad or in-fill between the fibres and ground surface. Second generation products began to appear in 1976 and were categorized by longer fibres with sand used to fill the spaces between the fibres and shockpads being incorporated under the surface. While 1st and 2nd generation artificial surfaces more resembled carpet due to their tightly packed fibres and limited in-fill/shockpad, newer 3rd generation surfaces were developed in the 1990's that were composed of less dense, fibrillated fibres which closely mimicked natural grass due to the addition of an in-fill composed of rubber and/or sand particles (Figure 2-5).

Many facilities installed 3rd generation in-fill surfaces due to the ability of these surfaces to permit higher usage due to their greater durability, allow for year round activity as well as being labeled as ‘low maintenance’, when compared to grass.

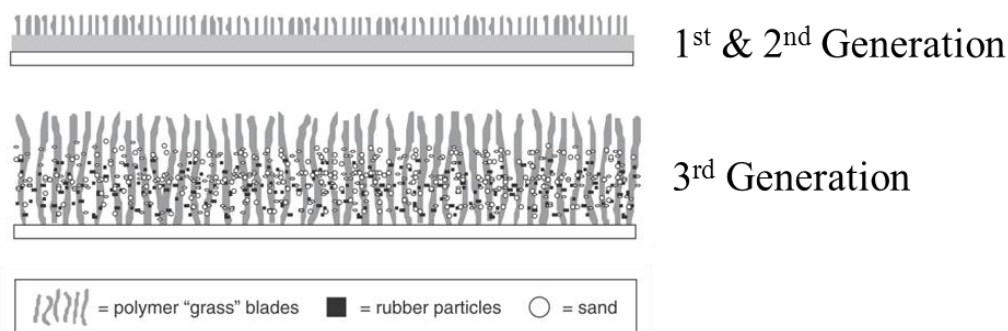

Figure 2-5: Diagram of the different generations of turf (adapted from Livesay et al. 2006).

2.3.1 Surface Related Injury

Since the first development and implementation of artificial turf, studies have sought to determine how comparable these surfaces were to natural grass. Early studies were quick to point out that these first and second generation surfaces produced much higher injury rates than natural grass (Bramwell et al. 1972; Stanitski et al. 1974; Torg et al. 1974; Bonstingl et al. 1975; Alles et al. 1979; Lambson et al. 1996;). One study found that knee injuries were 25% more common on first generation turfs (injury rate of 1.0 per 1000 exposures) compared to natural grass (injury rate of 0.8 per 1000 exposures) (Skovron et al. 1990). The risk of ankle sprains have also been shown to be 29% higher on artificial turf (injury rate of 0.45 per 1000 exposures) compared to natural grass (injury rate of 0.32 per 1000 exposures) in American football (Skovron et al. 1990). A study in the National Football League also showed a higher injury rate on artificial surfaces (1.94 injuries per

team game) compared to natural grass (1.78 injuries per team game) when only lower extremity injuries were taken into account (Skovron et al. 1990).

Artificial turf not only increased the risk of lower extremity injuries, but when all injuries were accounted for, injury rates were as much as 1.8 times higher on artificial turf compared to natural grass (Stevenson & Anderson 1981) with these injuries being mostly severe in nature (Bowers & Martin 1975). One of the major limitations with these previous injury studies is the fact that the studies were conducted in different locations, on different fields, with different players, over different years, or during different times of the year, which may bias the result. A study in 1981 was conducted in order to reduce these biases by performing a randomized control study in which 64 recreational football teams had their games randomly assigned to either be played on artificial turf or natural grass over the course of the year. The results were consistent with previous studies as artificial turf had a much higher injury rate compared to natural grass (relative risk on artificial turf was 1.84) (Stevenson & Anderson 1981).

Overall, an increase in lower extremity injury of 30-50% (Skovron et al. 1990) occurred when sports were played on these first and second generation artificial surfaces. This is not surprising considering the fact that first and second generation surfaces were much more like carpet than grass, resulting in much higher traction values.

The newer third generation surfaces have had much more conflicting results when comparing injury rates between these new surfaces and natural grass. Three in-depth

injury studies have been conducted comparing 3rd generation artificial turf surfaces and natural grass. The first study was a five year prospective study conducted in 2004, which compared the injury rates of 240 games (150 played on artificial turf (Fieldturf) and 90 played on grass) of 8 Texas high school football teams (Meyers & Barnhill 2004). The results showed that the different surfaces created different types of injuries. There was a greater incidence of ACL injuries and ligament trauma as a whole on grass, while there were greater surface injuries (skin contusions), muscle strains, as well as a higher incidence of non-contact injury on artificial turf, which resulted in an overall greater injury rate on artificial turf.

A study in 2007 examined injury rates on artificial turf and grass in soccer of 2020 players (Fuller et al. 2007). The study found a similar overall rate of injury (8.3 injuries per 1000 hours of exposure on grass and 8.7 injuries per 1000 hours of exposure on turf) between the surfaces, but greater incidence of lower extremity injury (6.8 injuries per 1000 hours of exposure compared to 7.4 per 1000 hours of exposure on grass and artificial turf respectively), specifically knee (1.1 injuries per 1000 hours of exposure compared to 1.9 per 1000 hours of exposure on grass and artificial turf respectively) and ankle (3.0 injuries per 1000 hours of exposure compared to 4.0 injuries per 1000 hours of exposure on grass and artificial turf respectively) injuries on artificial turf. As well, non-contact injuries were much higher on artificial turf (3.1 injuries per 1000 hours of exposure) compared to grass (2.8 per 1000 hours of exposure).

A follow-up study by Meyers et al., (2010) to his 2004 study, examined injury rates of collegiate athletes as opposed to high school athletes with a three year prospective study. Twenty-four universities participated with 465 games (230 on artificial turf (Fieldturf) and 235 on grass). In contrast to their previous study, no significant differences in injury rates between the two surfaces were found. The results displayed more minor but less substantial and major trauma on artificial turf, with no differences in head or knee injury between surfaces. The contradictory results of the 2010 study with the 2004 study are puzzling. The major difference between the studies was the competition level of the athletes and perhaps athletes at the higher collegiate level reported their injuries to a lesser degree or continued playing through the injury to a greater extent compared to the high school athletes. While these studies provided some insight into the difference in injury rates between the two surfaces, they did nothing in regards to determining the mechanism of these differences. The author did speculate that footwear traction could be one of the causes of the injury, however the authors seemed to contradict themselves, by stating in the 2004 study that the high torque (rotational traction) produced on field turf may be the cause for the increased injury rates on the artificial turf, then stating in the 2010 study that the consistent field turf surface likely reduced the traction leading to lower injuries.

These injury studies helped identify that there may still be differences in injury rates between the new artificial turf surfaces and natural grass, but the mechanism or cause of these injury differences is still not known. All three studies seemed to revert back to the shoe-surface traction as the possible mechanism, but none of the studies measured the

traction and the studies by Meyers seemed unsure as to whether or not artificial turf increased the traction over natural grass.

2.3.2 Surface Traction

While many studies have been conducted examining how injuries can vary based on surfaces, not many have included one key factor, which is the actual measurement of the traction. In early generations of artificial turf (1st and 2nd), there were specially designed footwear for use on the surface (turf shoes), as athletes could not wear cleated footwear due to the inability of the longer cleats to penetrate the hard surfaces. Athletes instead wore special turf shoes which consisted of a large number of smaller rubber studs or simply ordinary running shoes when performing on artificial turf. In general, the combination of shoe and 1st and 2nd generation turf produced higher traction than a cleated shoe of natural grass (Stanitski et al. 1974; Bonstingl et al. 1975; Mallette 1996; Livesay et al. 2006), which potentially relates itself to the increase in injury rate seen early on with artificial surfaces.

The infill of new surfaces enables the athletes to wear cleated footwear (the same footwear worn on natural grass) on these artificial surfaces. Various studies have compared the traction of the same footwear on natural grass and artificial turf, with the results again being that artificial turf continues to have higher traction than natural grass (Villwock et al. 2009b). Traction on artificial turf is very complex and studies have shown that many aspects can affect the traction of the surface, including the infill used (Villwock et al. 2009a), the fibre structure of the artificial surface (Villwock et al. 2009a),

the maintenance or contamination of the surface (James & McLeod 2010), the surface hardness (Severn et al. 2011), infill compaction, surface wear, whether the tests are laboratory or field tests, stud configuration (Severn et al. 2010), surface temperature (Torg et al. 1996), and surface moisture (Bowers & Martin 1975).

The previous injury studies conducted on 3rd generation artificial surfaces (Meyers & Barnhill 2004; Meyers 2010) all speculated that the increase in lower extremity injuries, especially non-contact injury could be caused by the differences in footwear traction between the surfaces, yet not one of the studies measured the traction on the two surfaces. Studies examining injury rates and footwear traction in parallel similar to the study by Lambson et al., (1996) but conducted on third generation surfaces are still missing. This is much more difficult than first thought as there are many different brands, types, shapes and sizes of cleated footwear currently used and available to athletes. These different brands and types of shoes will certainly have different traction from one another. Also due to the differences between the surfaces, footwear that has high traction on grass may not have high traction on artificial turf, something that the athlete may not be aware of.

The relationship between footwear traction and lower extremity injury is very complex, and has been examined since before the 1970's. While studies have provided some direct evidence that high rotational traction can relate to higher rates of injury (Lambson et al., 1996) specific answers to the relationship between traction and injury is mostly based on speculation. New artificial turf surfaces have been developed that provide an infill material, making the surface properties much closer to natural grass, however,

information is lacking regarding how the footwear traction and especially number of injuries on these new surfaces are affected. No studies have examined how these new surfaces have affected footwear traction and injury in parallel.

Chapter Three: Footwear Traction in Canadian High School Football

3.1 Introduction

Injuries to the lower extremity are some of the most common injuries found in sport. Ankle sprains are the most prevalent musculoskeletal injury and several studies have noted that sports that require sudden stops and cutting maneuvers, such as football and basketball cause the highest percentage of these injuries (Yeung et al. 1994; Hosea et al. 2000). Damage to the anterior cruciate ligament (ACL) is a frequent injury of the knee, and the mechanism is by sudden deceleration, cutting or pivoting, hyperextension or hyperflexion, or by a blow to the postero-lateral aspect of the knee (Arendt & Dick 1995).

The cost for the medical treatment of these lower extremity injuries is substantial. Direct figures for gridiron football could not be found in the literature; however football has been shown to have the highest percentage of injuries of all high school sports with 61% of athletes becoming injured during the season (McLain & Reynolds 1989) and 59% of the injuries involving the lower extremity (Tuberville et al. 2003).

One of the leading contributors to lower extremity injury in sport is thought to be due to the traction of the shoe-surface interface. Traction is an important aspect in sport with most athletes attributing an increase in traction to an increase in performance. Traction is a property of both the shoe and surface and is often divided into two components; linear translational traction and rotational traction. Translational traction is usually defined as a coefficient determined from the ratio of horizontal force to the force perpendicular to the

surface. Rotational traction is described using the peak moment of rotation with respect to the centre of pressure (Nigg & Yeadon 1987), which refers to rotation of the foot around a point of contact on the shoe sole (Frederick 1986). Other factors such as the applied load, foot placement, and the shoe-surface contact area also have been thought to affect traction (Torg et al. 1974; Valiant 1993).

Several studies have shown an increase in injury with shoes that encompass high traction. A study by Lambson et al., (1996) found that footwear with higher rotational traction in football lead to a greater number of ACL injuries. More specifically shoes which had studs around the periphery, which were termed Edge cleats, were found to have the highest rotational traction. As well Wannop et al., (2010) demonstrated that an increase in footwear traction can lead to an increase in knee and ankle joint loading which is thought to cause injury (Stefanyshyn et al. 2006).

When studying traction most studies have used sample surfaces, and/or sample shoes, and have sometimes measured the traction months or years after injury data collection (Torg & Quedenfeld 1971; Torg & Quedenfeld 1973; Stanitski & McMaster 1974; Torg et al. 1974; Bowers & Martin 1975; Andreasson et al. 1986; Ekstrand & Nigg 1989; Heidt et al. 1996; Torg et al. 1996; Myklebust et al. 1997; Myklebust et al. 1998). This may not give an accurate representation of what is actually occurring as the sample surface and sample shoe may differ substantially from the real playing surface and shoes worn by athletes. A previous study by Villwock et al., (2009b) tested the rotational traction on the actual field of play using 10 different football cleats on four surfaces. While this study

obtained more accurate traction measurements by testing on the field of play, limitations were still present. During testing, the air temperature varied as much as 21°C between surfaces, which has been shown to affect traction measurements (Torg et al. 1996), although the effect on traction did not seem to be systematic. The researchers only measured rotational traction and only new cleats were tested on the surface. The majority of time in sport, the cleats worn by the athletes will not be new.

The intricate interplay between footwear and injury is not fully understood and many questions such as the role of translational traction on injury and the role of natural vs. artificial turf still remain. As an initial step in further understanding the role of footwear traction, the purpose of this study was to determine the range of translational and rotational traction that exists in cleated footwear of athletes, on the actual surface of play of a natural grass field as well as an artificial turf field in Canadian high school football.

3.2 Methods

Over the course of three years, the shoes of 555 athletes were tested on the football field of play using a portable robotic testing machine (Figure 3-1). The field of play consisted of a natural grass turf composed of Kentucky Blue Grass, as well as an artificial turf surface. The artificial turf surface consisted of the 2.5 inch Duraspine product installed by Fieldturf. The surface contained 4.55 kilograms per square foot of in-fill consisting of 3.19 kilograms of silica sand plus 1.36 kilograms of cryogenic rubber. The in-fill was installed with an initial base layer of silica sand, followed by 8-10 applications of a silica

sand/rubber mixture, finished with a final top layer of larger sized cryogenic rubber particles.

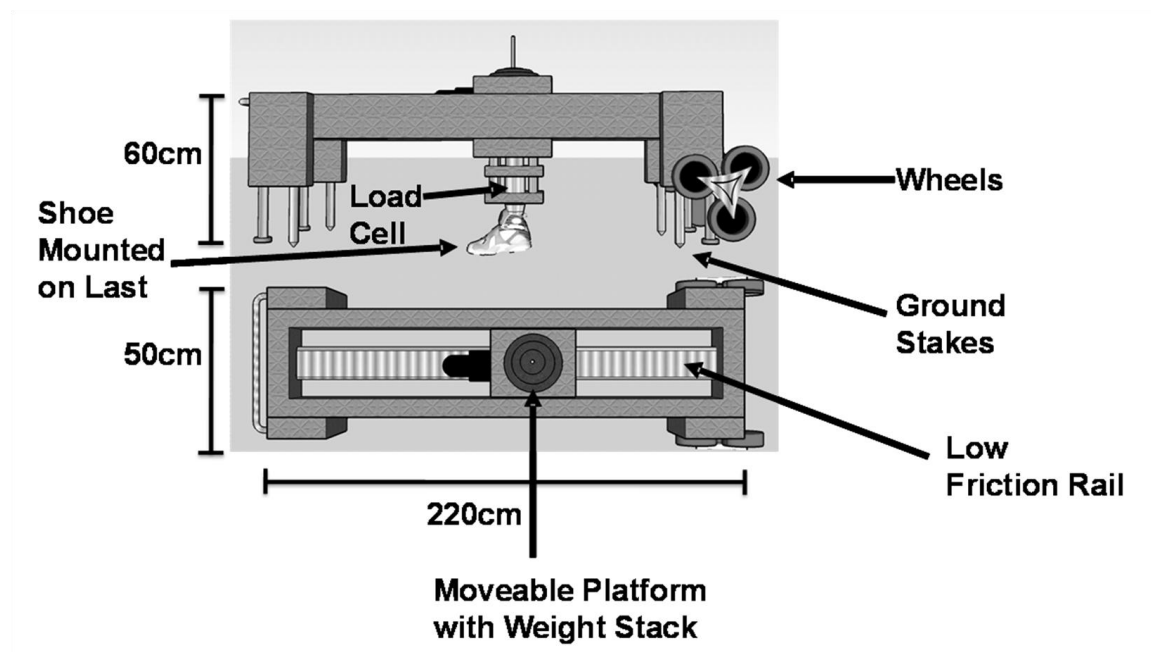

Figure 3-1: Frontal and top view schematic diagram of the portable traction testing machine. The machine had a weight of 1870N.

The machine was provided by adidas (Portland, Or, USA) and consisted of a stiff base on which a single guide rail was mounted. A load bearing movable platform slid freely on the polished guide rail by means of low friction, linear bearings. The platform incorporated a structure for holding a vertical shaft. The shaft is mounted on bearings so that it may rotate freely. A support at the top of the shaft allows weights to be added. Measurements of the translational and rotational traction were determined using a normal load of 580N. This load was used during pilot testing and found to be the most physiologically relevant load that could be used that was both repeatable and caused

minimal damage to the playing field. At the bottom end of the shaft, a last and test shoe were attached, with the shoe being placed in 20° of plantar-flexion placing only the forefoot cleats in contact with the ground in order to simulate the foot orientation during a cutting movement. The machine was powered and controlled by a stand-alone, portable touch-screen computer.

For translational traction measurements, a hydraulic ram was attached to the platform using a cable. The force exerted by the hydraulic ram was measured using a force transducer bolted to the platform. The translational traction tests were conducted along the long axis of the shoe, which is more representative of the initial foot plant prior to a cutting maneuver. The platform and the attached mass were moved horizontally along the guide rail at a speed of 200mm/s moving a distance of 200mm, as initial testing showed this speed to have high reliability and it was the maximum speed that could be tested with no residual movement of the testing machine. The force transducer recorded the force resisting motion of the carriage. This horizontal force divided by the vertical force was equal to the translational traction between the shoe and playing field.

For rotational traction, the vertical shaft was unlocked and free to rotate, with the rotational axis of the tester in line with the forefoot. By unlocking the vertical shaft, the moment generated by the cable was determined by multiplying the force measured by the force transducer with the moment arm of the shaft. The shaft was rotated at a speed of $90^{\circ}/s$ over a distance of 70° .

Three trials per shoe-surface condition were collected with the force transducer sampling at a frequency of 2000Hz, as initial data have shown the results of the traction tester to be reliable and consistent (Table 3-1, Table 3-2). The validity of the traction tester was confirmed by laboratory shoe testing over a force platform. The data from the traction tester and force plate were compared and found to be in very good agreement (Figure 3-2).

Table 3-1. Within day repeatability of the traction tester (Nike Type G shoe)

Trial #	Grass		Artificial Turf	
	Translational	Rotational [Nm]	Translational	Rotational [Nm]
1	0.743	30.1	0.680	36.8
2	0.785	25.3	0.709	35.4
3	0.778	26.8	0.695	35.3
Mean	0.769	27.4	0.695	35.8
Standard Deviation	0.023	2.5	0.015	0.8

Table 3-2. Between day repeatability of the traction tester (Nike Type G shoe)

Day #	Grass		Artificial Turf	
	Translational	Rotational [Nm]	Translational	Rotational [Nm]
1	0.747	28.5	0.707	40.1
2	0.769	27.4	0.716	42.4
3	0.750	32.2	0.695	35.8
Mean	0.755	29.3	0.706	39.4
Standard Deviation	0.012	2.5	0.010	3.4

Traction Compared Between Force Plate and Portable Traction Tester

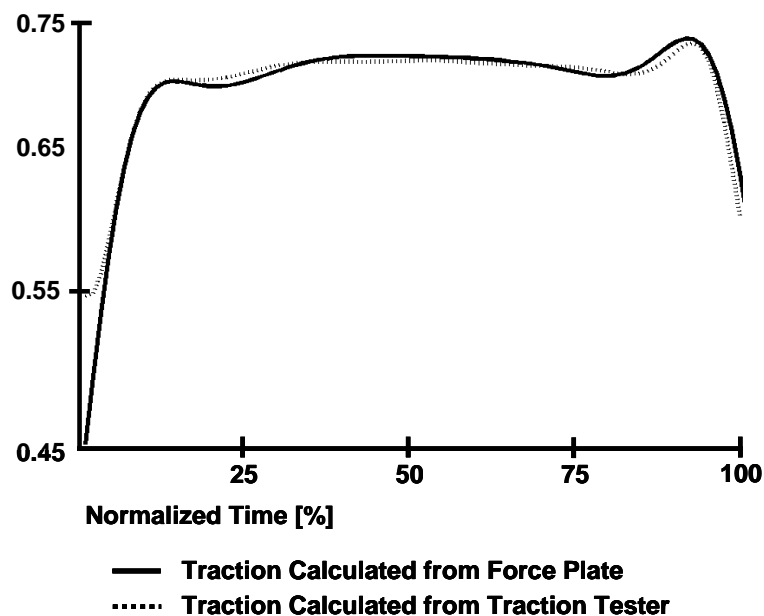

Figure 3-2: Comparison of the translational coefficient of traction compared when calculated from the force plate data, and the portable traction tester load cell data. Data are a mean of three trials.

In order to determine between day repeatability on the field, a sample cleat was tested on each day at the start of testing. The shoe was a Nike type H cleat, and the mean and standard deviation of the translational and rotational traction measured on different testing days was found to be 0.70 ± 0.04 and $23.1 \pm 3.7 \text{ Nm}$ on natural grass and 0.68 ± 0.03 and $40.1 \pm 1.90 \text{ Nm}$ on artificial turf. The mean temperature during the on field traction testing between all testing days was $10.6 \pm 5.4^\circ \text{C}$.

All shoes were collected from the athletes and tested at Shouldice athletic park, where all local high school football games take place. The shoes consisted of a representative randomly selected sample ranging from size US 7-15 with a mean of size US 11 and

mode of size US 10. The shoes came from 555 athletes whose age, mass and height had a mean and standard deviation of 16.3 ± 0.7 years, 79.5 ± 14.1 kg and 1.79 ± 0.06 m respectively. For traction testing the shoes were all tested along the outer edge of the field, as this seemed to be the most consistent and have the best field surface conditions. The brand, size and mass of the shoes were recorded and photographs were taken. For analysis, all shoes were grouped into one of three cleat arrangement categories; edge, stud and fin (Figure 3-3). Edge shoes were defined by long cleats placed at the peripheral margin of the sole, stud cleats by a large number of small rubber studs on the sole, and fin by a large number of rubber fins placed in varying directions. The average peak translational traction and peak moment of rotation for all three trials of each shoe were analyzed. ANOVAs were used to compare all conditions at a significance level of 0.05, with post hoc analysis performed to determine where any differences lay.

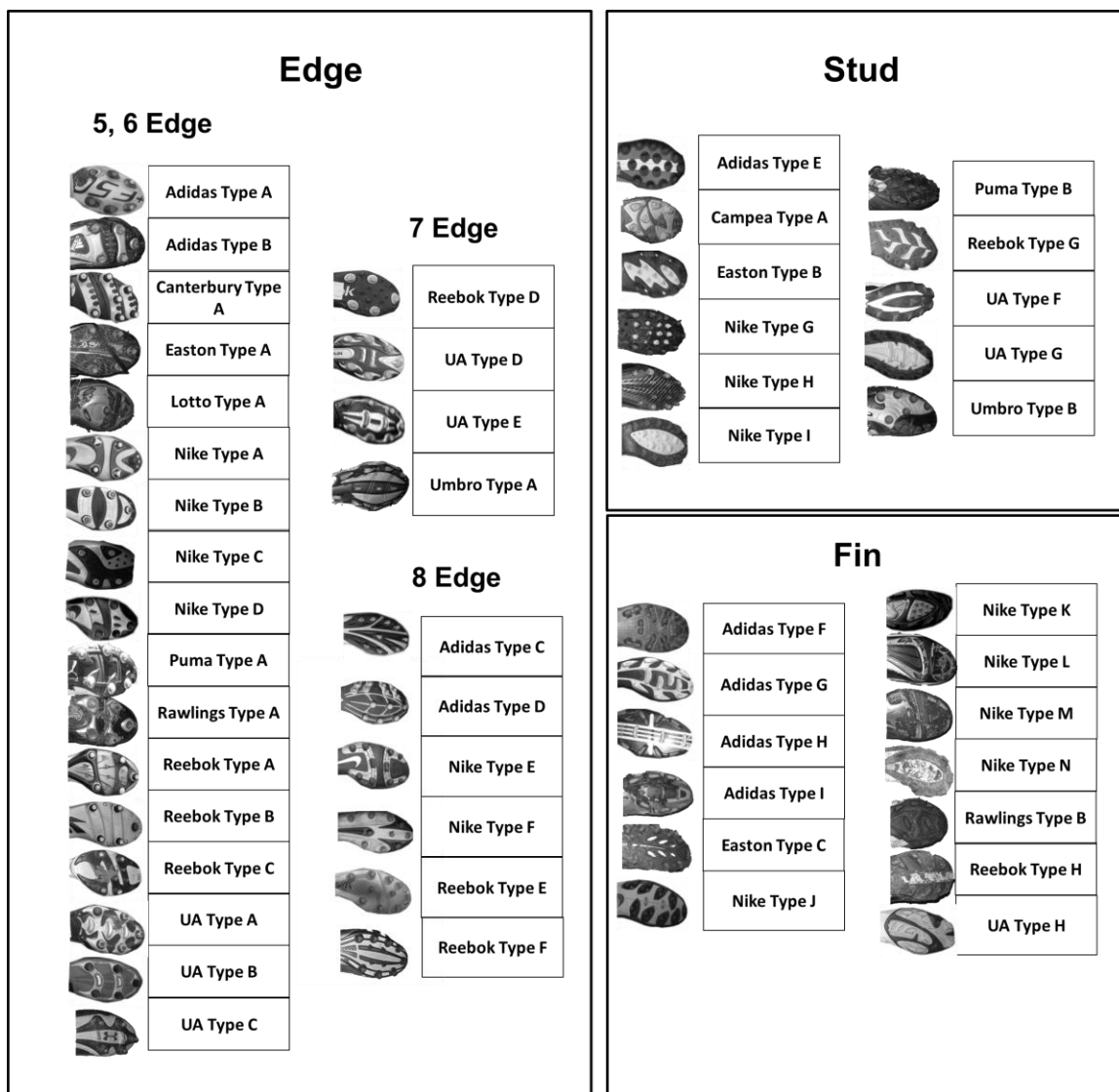

Figure 3-3: Photographs and grouping of the tested cleats. The 5 and 6 edge group have been combined due to there only being one 6 edge cleat which had similar traction to the 5 edge cleat group.

3.3 Results

Representative sample curves of both the translational traction coefficient and the rotational traction can be seen in Figure 3-4. The coefficient of translational traction and the peak moment of rotation for all shoes studied on the grass surface ranged from 0.48-0.97 with a mean of 0.71 ± 0.08 , and 15.0Nm-52.7Nm with a mean of 30.0 ± 10.7 Nm

respectively. On artificial turf the coefficient of translational traction and the peak moment of rotation for all shoes studied ranged from 0.61-0.83 with a mean of 0.70 ± 0.032 , and 24.5Nm-54.9Nm with a mean of 40.5 ± 6.49 Nm respectively. When comparing between grass and artificial turf of all shoes, grass had significantly higher translational traction ($p=0.011$) but significantly lower rotational traction ($p<0.001$) (Figure 3-5).

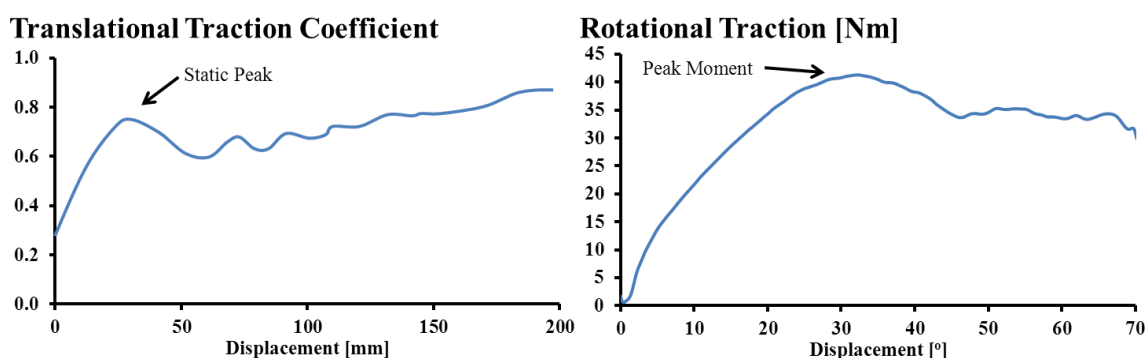

Figure 3-4: Representative sample traces of translational and rotational traction measurements vs. displacement.

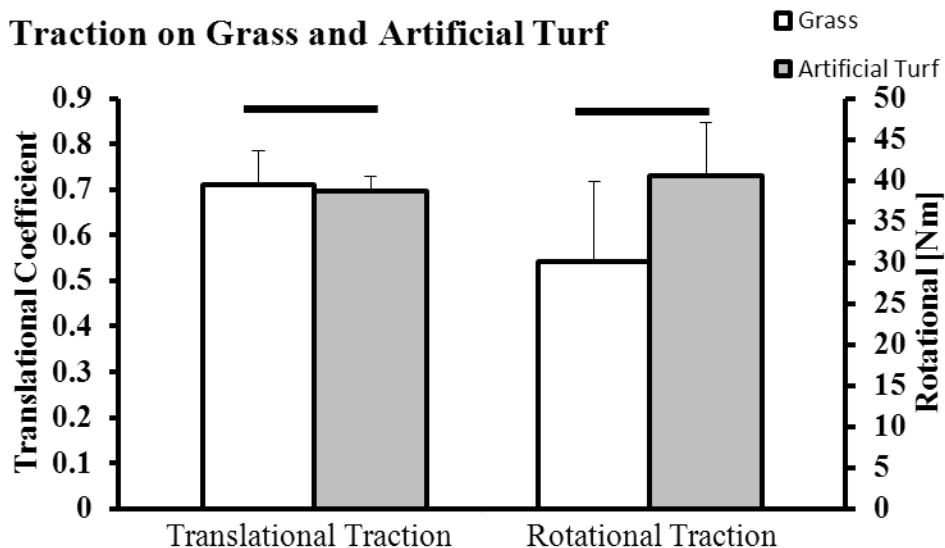

Figure 3-5: Translational and rotational traction of all shoes on the grass and artificial turf surface. Black horizontal bars represent a significant difference.

When grouped by cleat arrangement (Figure 3-6), the stud shoes had significantly higher translational traction than the edge shoe ($p=0.002$) as well as significantly higher rotational traction than the fin ($p<0.001$) and the edge shoe ($p=0.001$) on grass. The edge group also had the trend of having higher rotational traction compared to the fin shoe ($p=0.053$). On artificial turf, the fin shoe had significantly higher translational traction compared to the edge ($p<0.001$) and stud ($p=0.029$) groups. As well the stud shoe had significantly higher traction compared to the edge group ($p=0.016$). No differences were seen between the groups in terms of rotational traction on the artificial turf (Figure 3-6).

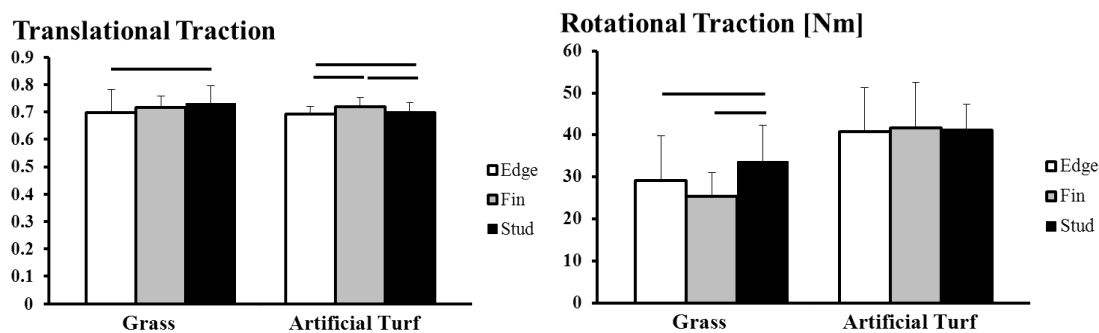

Figure 3-6: Translational and rotational traction grouped by cleat type of all tested cleats. Black horizontal bars represent a significant difference.

3.4 Discussion

Injuries to the lower extremity are very common and expensive in sport costing not only money for treatment but also time away from sport. It is generally believed that excessive traction of the shoe-surface interface may be a trigger for non-contact injuries (Bramwell et al. 1972; Torg et al. 1974; Luethi & Nigg 1985; Skovron et al. 1990; Lambson et al. 1996).

Various traction and injury studies have been performed with the main conclusions being that shoes with higher rotational traction produce more injuries (Torg et al. 1974; Lambson et al. 1996). It has been found that when the traction properties of the shoe and surface are increased, an increase in joint loading also occurs, specifically in the frontal plane and transverse plane (Wannop et al. 2010), which are believed to be the planes associated with injury (Besier et al. 2001; Stefanyshyn et al. 2006).

While previous studies have answered some questions regarding footwear traction and injury, many still remain. The majority of these studies collected traction data on sample surfaces in the laboratory using new sample shoes (Torg et al. 1974; Heidt et al. 1996; Lambson et al. 2006). These values may not represent what occurs in a real game situation. The one study that did collect data on the surface of play (Villwock et al. 2009b) used brand new sample shoes, collected only rotational traction data and performed data collection at different temperatures, which has been shown to affect traction (Torg et al. 1996).

The current study was, therefore, performed as an initial step in further understanding the role of footwear traction. The purpose of this study was to determine the range of translational and rotational traction that exists in cleated footwear of athletes, on the actual surface of play of a natural grass and an artificial turf surface in Canadian high school football.

When examining all the footwear used in Canadian high school football, average translational traction was over 4% higher on the natural grass field, while average rotational traction was over 24% lower on the natural grass surface compared to the artificial surface. These differences in traction were surprising, specifically the higher translational traction on natural grass. Many previous studies have pointed to the coupling between translational and rotational traction, with an increase in one aspect resulting in an increase in the other aspect (Van Gheluwe et al. 1983), but that does not appear to always be the case. In that regard, the majority of previous studies only collected rotational data when testing traction, due to the belief that it is the important component of traction in relation to injury. Based on the results of the current experiment that translational and rotational traction are not always coupled, these studies may be overlooking an important aspect associated with the injury mechanism. Early generations of artificial turf had higher translational as well as rotational traction, which was attributed to the increase in injury risk found on these artificial surfaces (Stanitski et al. 1974; Torg et al. 1974; Lambson et al. 1996). Recent studies have shown that the difference in injury between new third generation artificial surfaces and grass are small (Meyers & Barnhill 2004; Meyers 2010). This is interesting because the rotational traction of the artificial surface is still much higher than grass, which again brings to light the fact that translational traction may be somehow linked to injury risk.

The cause of the difference in translational and rotational traction on the two surfaces may be due to many factors such as the inclusion of the root zone structure on the natural grass as well as the difference in 'soils' between the two surfaces. The natural grass

surface is composed of a much harder and firmer dirt surface, which is believed to increase translational traction, while the artificial turf is composed of a softer infill material that can more easily move. This softer infill of the artificial surface may allow for the footwear to plow through the surface with much less force than the hard dirt of the grass, resulting in the lower translational traction. In terms of rotational traction the softer infill surface may have caused a screw type effect with the footwear, when the shoe was rotated, the softer, more movable infill, caused the shoe to screw somewhat into the surface, increasing the resistance to rotation.

When the cleats were broken into distinct cleat groups, the footwear reacted somewhat differently depending on the surface it was tested on. On grass, the stud shoe had the highest translational traction, while on artificial turf the fin shoe had the highest traction values. This indicates that these shoes react very differently to the different surfaces, with the fin shoe having the greatest change in traction based on the surface. In terms of rotational traction, on grass the stud shoe had the highest traction, while on artificial turf all footwear groups had similar traction values.

Even though footwear of the exact same type was tested, differences in traction were seen both on the natural grass and artificial turf. Large differences in translational and rotational traction could be seen on identical brands and models of shoes in different conditions (Figure 3-7). Shoes that were noticeably newer had much higher traction than the same model of shoe that was old and showed significant signs of wear. The new shoe had traction values of 0.84 and 50Nm compared to a noticeably worn shoe with values of

0.72 and 22Nm for translational and rotational traction respectively on grass. The same trend was seen for artificial turf, with the new shoe having traction values of 0.73 and 43.5Nm compared to the worn shoe which had values of 0.66 and 25.6Nm for translational and rotational traction respectively.

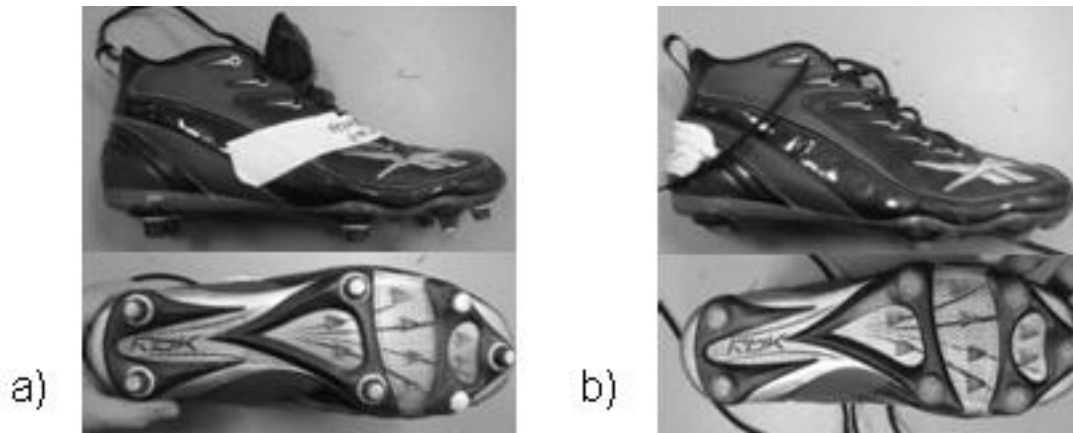

Figure 3-7: Photographs of a) a new shoe and b) a worn shoe.

This result that wear can affect traction is not surprising as it has been shown in a previous study that stud geometry and parameters can influence footwear traction (Kirk et al. 2006). From a mechanical perspective makes sense as in terms of the traction tests utilized in this study, plowing friction is the main method of force produced during the traction test. The cleats on the shoe can be simplified as hard spheres that plough their way through the much softer turf surface. Recalling our equation for translational traction:

$$\mu = \frac{F}{N}$$

Where μ is the translational traction, F is the friction force and N is the normal load. Simplifying each cleat as a simple sphere (Figure 3-8), the load support area during the

test is represented by the term A_L . Therefore $A_L=2\pi r^2$ since the stud is being pressed in the direction of motion. The friction force is produced by the area of the surface in contact with the stud or the penetration of the stud, represented by A_p . From Bhushan (1999) it is safe to assume that the yielding of the surface is isotropic with its yield pressure being represented by p , therefore:

$$N=pA_L \text{ and } F=pA_p$$

Setting up our traction equation again:

$$\mu = \frac{F}{N} = \frac{A_p}{A_L}$$

Simplifying the equation using the methods of Bhushan (1999):

$$\mu = \frac{4}{3\pi} \frac{r}{R}$$

From this equation it is easy to determine that μ increases rapidly with an increase in r/R , therefore as the cleat is worn down the radius of the sphere will decrease which will affect the penetration changing the area in contact with the surface and therefore the traction values.

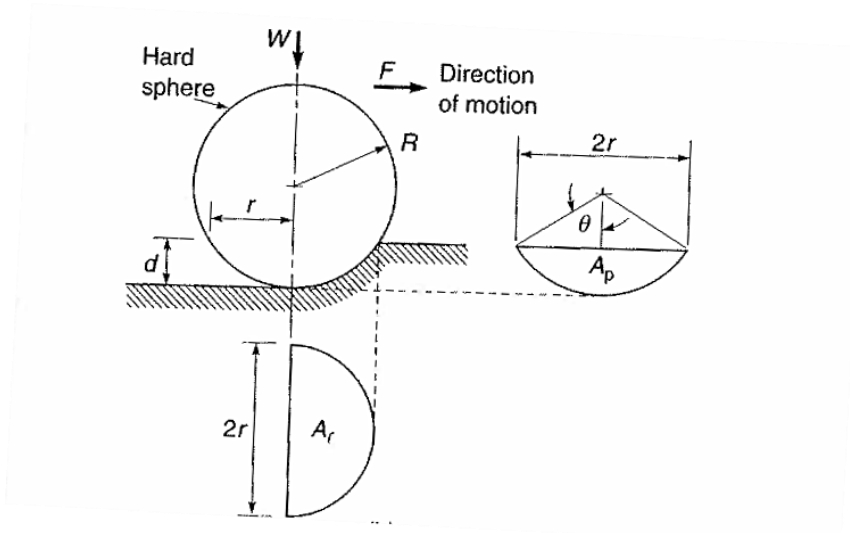

Figure 3-8: Diagram of individual cleats being represented as a hard sphere, plowing through the natural and artificial surface. Adapted from Bhushan (2002).

The fact that the traction of the footwear can change based on the condition of the shoe draws strength to the fact that when conducting footwear studies that relate to injuries, using sample shoes does not accurately reflect the traction of each athlete. Due to the effect of wear on the cleats, previous studies that used new sample shoes and surfaces may have overestimated the traction of the cleats. The traction values tested would have given higher values than what the athletes would be experiencing on the field due to the wear of the cleats. Using the athlete's footwear on the actual playing surface will result in a more accurate estimate of the traction that is available to each athlete.

3.5 Conclusions

When comparing footwear used by athletes in high school football, the translational traction of the footwear is higher on natural grass, while the rotational traction is higher

on artificial turf. The majority of cleats used in high school football are of the edge design. The cleats can be broken into three categories, with these categories having different translational traction on grass and turf, as well as different rotational traction on grass, with the rotational traction of artificial turf staying constant. Due to the wear seen in the cleats, collecting traction data using the athlete's footwear on the actual surface of play should result in a more accurate estimate of each athlete's traction. From this study it was shown that there is a large variety of shoes and traction present in high school football. Future work will concentrate on whether this variety of traction has an effect on injury, and whether the low traction of the fin shoe design affects performance.

Chapter Four: The Effect of Normal Load, Movement Speed and Moisture on Footwear Traction

4.1 Introduction

Footwear friction has been studied for many years and is thought to influence both injury occurrence and athletic performance (Lambson et al. 1996; Muller et al. 2010). Friction values are a property of both the shoe and surface and usually are divided into two components; translational friction and rotational friction. Translational friction is defined as a coefficient determined from the ratio of tangential force to the force normal to the surface, while rotational friction is described using the peak moment of rotation with respect to the center of pressure (Nigg and Yeadon 1987), which refers to rotation of the foot around a point of contact on the shoe sole (Frederick 1986).

When calculating mechanical dry friction, Amonton's laws govern the relationship that exists between the surfaces. Amonton's laws state: 1) the friction force is directly proportional to the applied load and 2) the friction force is independent of the apparent area of contact (Ateshian & Mow 2005). Previous studies have shown that friction of footwear does not follow these laws (Torg et al. 1974; Bowers & Martin 1975; Warren 1996; Livesay et al. 2006; Kuhlman et al. 2010) due to the non-uniform surface of shoe soles, coupled with the visco-elastic properties contained within the shoe soles (Nigg & Anton 1995); therefore, in this study footwear friction will be termed footwear traction.

Numerous studies have tested footwear traction using various normal loads, movement speeds, and on different surface conditions (Torg et al. 1974; Bonstingl et al. 1975;

Bowers & Martin 1975; Andreasson et al. 1986; Warren 1996; Heidt et al. 1996; Livesay et al. 2006; Villwock et al. 2009; Kuhlman et al. 2010), however, due to the divergence from Amonton's laws, the results of two different studies that tested footwear traction at different normal loads, or different movement speeds are difficult to compare. No studies have systematically altered the normal load, movement speed and surface conditions to determine the influence that each of these variables has on footwear traction. Therefore, the purpose of this study was to investigate how alterations of normal load, speed of testing and surface moisture affect footwear traction.

4.2 Methods

Data were collected on three types of footwear, Nike Speed Shark (stud), Under Armour Metal Speed II Low (edge), Nike Air Impact Shark (fin) (Figure 4-1), using a portable traction testing machine (Figure 3-1, chapter 3). The tester consisted of a stiff base on which a single guide rail was mounted. A load bearing movable platform slid freely on the polished guide rail by means of low friction, linear bearings. The platform incorporated a structure for holding a vertical shaft. The shaft was mounted on bearings so that it may rotate freely. A support at the top of the shaft allowed weights to be added. At the bottom end of the shaft, a last and test shoe were attached, with the machine being powered and controlled by a standalone, portable computer unit housed in a cabinet with the power supply and controlling components for the traction tester. For translational traction measurements, a hydraulic ram was attached to the platform. The force transducer recorded the force resisting motion of the carriage. This horizontal force divided by the vertical force was equal to the translational traction between the shoe and

playing field. The translational traction tests were conducted along the long axis of the shoe.

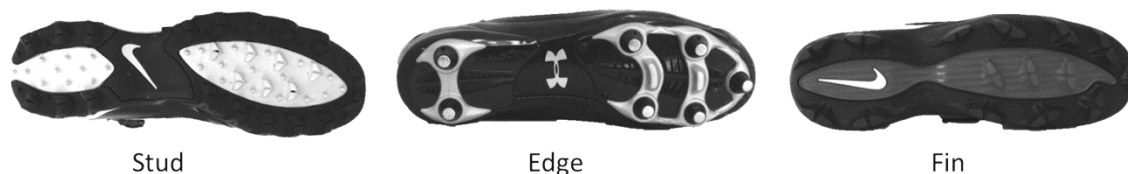

Figure 4-1: Photographs of the shoes tested.

For rotational traction, the vertical shaft was unlocked and free to rotate, with the rotational axis of the tester in line with the forefoot. By unlocking the vertical shaft, the moment generated was determined by multiplying the force measured by the force transducer with the moment arm of the shaft.

During testing each shoe was placed in 20° of plantar flexion with only the forefoot in contact with the ground. The shoe was placed in this orientation in order to best simulate the foot orientation during a cutting movement. Five trials per shoe-surface condition were collected with the force transducer sampling at a frequency of 2000Hz. The validity and repeatability of the tester has been confirmed in a previous study (Wannop et al. 2009).

To determine the effect that normal load had on translational and rotational traction, measurements were taken with vertical loads of 335N, 433N, 580N, 678N and 776N (the

lowest normal load the machine could achieve was 335N, while the highest load that could be tested with minimal damage to the field was 776N), with testing order randomized. These loads were selected as they were somewhat equal increments, and represented the max and minimum values that the tester and field could safely handle. The movement speed of the tester was set at 200mm/s moving a distance of 200mm for translational traction and 90°/s for rotational traction moving a distance of 70°.

To determine the effect of altering movement speed on traction, translational tests were performed using speeds of 50mm/s, 100mm/s, 150mm/s and 200mm/s, and rotational tests performed using speeds of 30°/s, 60°/s and 90°/s all with a total normal load of 580N.

To determine the effect of moisture on traction, measurements were first taken on a dry area of the field (0 moisture), an area with 1.37mL/cm² (1X moisture) of water added onto the surface and an area with 2.74mL/cm² (2X moisture) added onto the surface.

Testing was performed both on a field composed of natural grass (Kentucky bluegrass) and a field composed of artificial turf (Fieldturf) on the same day. After each trial, the shoe and tester were moved to a different location on the field, within the same relative vicinity but on a fresh piece of turf. The artificial turf surface consisted of the 2.5 inch Duraspine product installed by Fieldturf. The surface contained 4.55 kilograms per square foot of in-fill consisting of 3.19 kilograms of silica sand plus 1.36 kilograms of cryogenic rubber. The infill was installed with an initial base layer of silica sand,

followed by 8-10 applications of a silica sand/rubber mixture, finished with a final top layer of larger sized cryogenic rubber particles.

For both translational and rotational tests, the peak static traction value during each trial was selected and the average of these peaks for all trials was analyzed. To determine the relationships between traction and normal load, speed of movement and moisture, the coefficient of determination (R^2) was calculated using a linear least squares fit (Pearson correlation) in SPSS 10 (SPSS Science Inc, Chicago, Ill) with the significance of the regression being set at a 95% level of confidence.

4.3 Results

The effect of normal load, movement speed and surface moisture on footwear traction can be seen in Figure 4-2, Figure 4-3 and Figure 4-4 respectively. All regression analysis data, R^2 values and p-values can be seen in Table 4-1 for the grass surface and Table 4-2 for the artificial turf surface.

Table 4-1. Regression analysis on natural grass.

Variable	Shoe	Translational Traction			Rotational Traction		
		Equation	R ²	p-value	Equation	R ²	p-value
Load	Stud	$y = 0.0002x + 0.5990$	0.9396	0.006	$y = 0.0146x + 24.84$	0.9447	0.006
	Edge	$y = 0.0003x + 0.4666$	0.9762	0.002	$y = 0.0215x + 14.55$	0.9739	0.002
	Fin	$y = 0.0003x + 0.4482$	0.9685	0.002	$y = 0.0188x + 15.23$	0.9743	0.002
Speed	Stud	$y = 0.0017x + 0.3980$	0.9423	0.029	$y = -0.0086x + 34.09$	0.1753	0.725
	Edge	$y = 0.0016x + 0.3722$	0.9978	0.001	$y = 0.0066x + 32.87$	0.3145	0.901
	Fin	$y = 0.0016x + 0.3634$	0.9998	< 0.001	$y = 0.0086x + 31.60$	0.2509	0.666
Moisture	Stud	$y = -0.0208x + 0.6680$	0.2216	0.688	$y = 0.8824x + 32.86$	0.176	0.724
	Edge	$y = 0.0058x + 0.6821$	0.9257	0.176	$y = 0.8571x + 31.46$	0.9866	0.074
	Fin	$y = 0.0104x + 0.6709$	0.6449	0.406	$y = 1.9006x + 30.91$	0.9926	0.055

Table 4-2. Regression analysis on artificial turf.

Variable	Shoe	Translational Traction			Rotational Traction		
		Equation	R ²	p-value	Equation	R ²	p-value
Load	Stud	$y = 0.0003x + 0.5749$	0.9835	0.001	$y = 0.0365x + 32.61$	0.9949	< 0.001
	Edge	$y = 0.0003x + 0.4644$	0.9842	0.001	$y = 0.03314x + 32.54$	0.9898	< 0.001
	Fin	$y = 0.0003x + 0.4615$	0.9685	0.002	$y = 0.0372x + 33.51$	0.9718	0.002
Speed	Stud	$y = 0.0019x + 0.3434$	0.9952	0.002	$y = -0.022x + 51.65$	0.2476	0.668
	Edge	$y = 0.0019x + 0.3559$	0.9975	0.001	$y = 0.0061x + 49.44$	0.0743	0.824
	Fin	$y = 0.0016x + 0.3563$	0.9751	0.013	$y = -0.009x + 54.14$	0.0331	0.884
Moisture	Stud	$y = -0.04x + 0.6760$	0.6404	0.723	$y = -4.3771x + 47.48$	0.9761	0.099
	Edge	$y = -0.018x + 0.6970$	0.3283	0.612	$y = -2.8065x + 46.33$	0.9328	0.167
	Fin	$y = -0.0093x + 0.6644$	0.1776	0.409	$y = -3.5082x + 48.00$	0.7089	0.363

The effect of normal load on footwear traction can be seen in Figure 4-2. Both translational and rotational traction had a significant linear increase with normal load regardless of the shoe or surface tested. The R^2 values had a range of 0.9396 to 0.9762 on the grass and 0.9685 to 0.9842 on the artificial turf for translational traction. For rotational traction, the R^2 values were in the range of 0.9447 to 0.9743 on grass and 0.9718 to 0.9949 for the artificial turf surface.

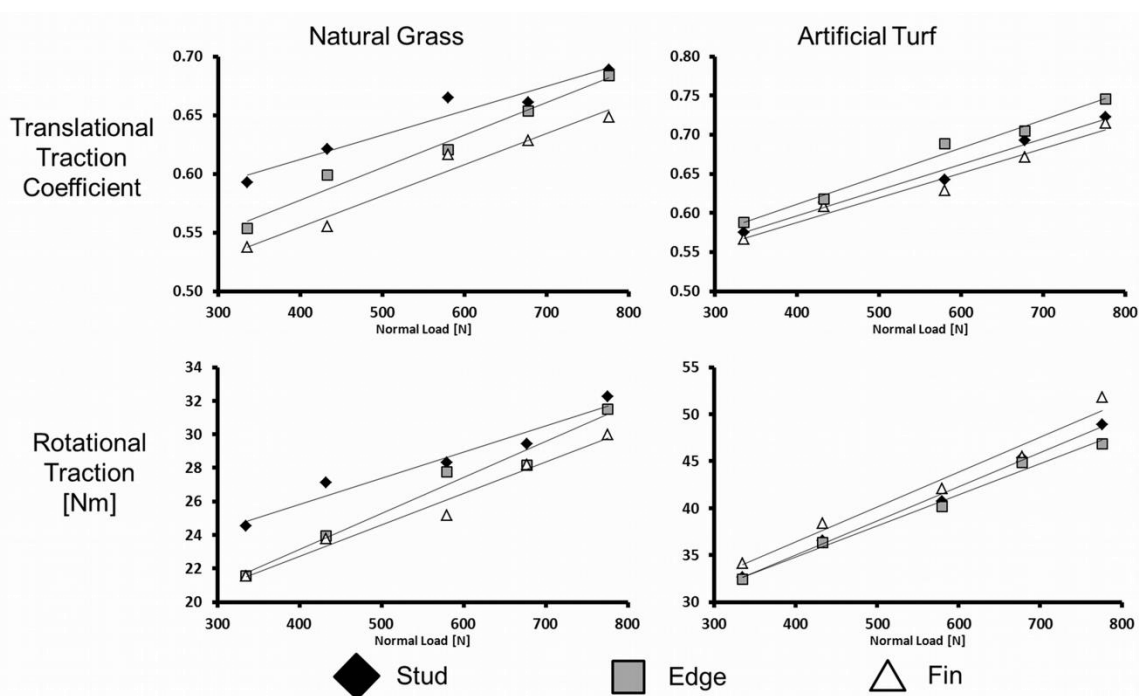

Figure 4-2: Effect of normal load on translational (top row) and rotational (bottom row) traction. The left column is traction on the natural grass surface, while the right column is traction on the artificial turf surface.

The effect of movement speed on traction can be seen in Figure 4-3. Translational traction had a significant linear increase with movement speed regardless of shoe or surface tested, with R^2 values in the range of 0.9423 to 0.9998 on grass and 0.9751 to

0.9975 on artificial turf. For rotational traction, the traction values seemed to stay constant with no significant correlation present, regardless of shoe or surface. The R^2 values were in the range of 0.1753 to 0.3145 on the grass and 0.0331 to 0.2476 on the artificial turf.

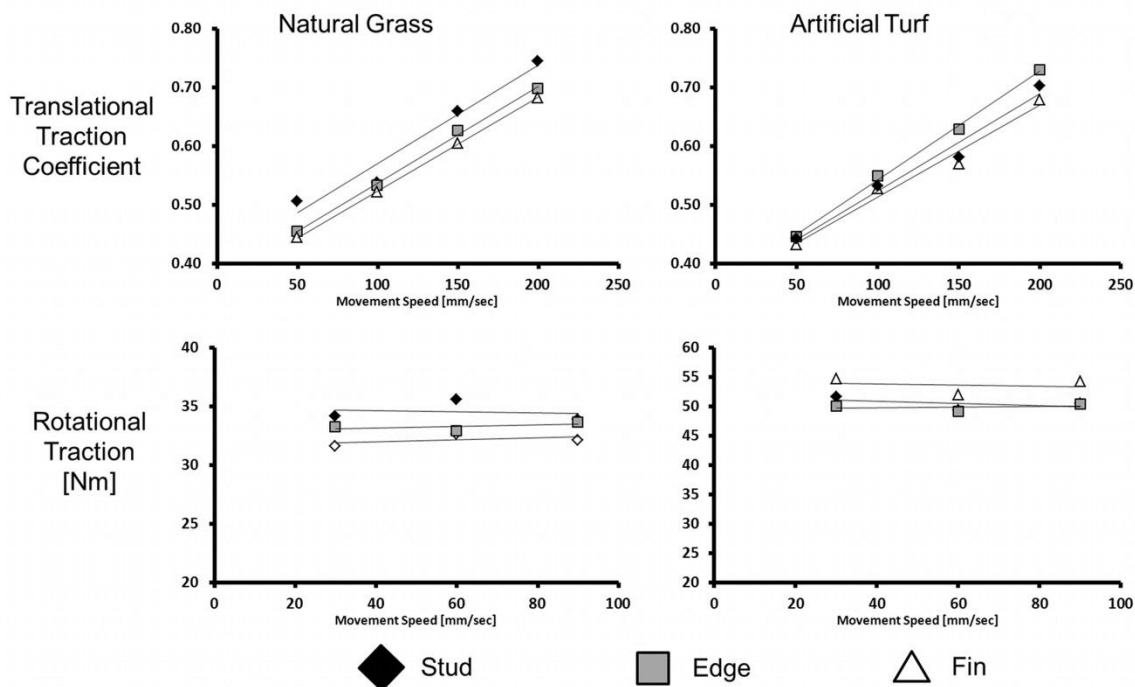

Figure 4-3: Effect of movement speed on translational (top row) and rotational (bottom row) traction. The left column is traction on the natural grass surface, while the right column is traction on the artificial turf surface.

The effect of moisture on each surface can be seen in Figure 4-4. The stud, edge and fin shoes had R^2 values of 0.2216 ($p=0.688$), 0.9257 ($p=0.176$) and 0.6449 ($p=0.406$) on grass and R^2 values of 0.6404 ($p=0.723$), 0.3283 ($p=0.612$), and 0.1776 ($p=0.409$) on artificial turf in terms of translational traction. For rotational traction, R^2 values of 0.1760 ($p=0.724$), 0.9866 ($p=0.074$) and 0.9926 ($p=0.055$) were seen on grass and R^2 values of

0.9761 ($p=0.099$), 0.9328 ($p=0.167$), and 0.7089 ($p=0.363$) on artificial turf for the stud, edge and fin shoe.

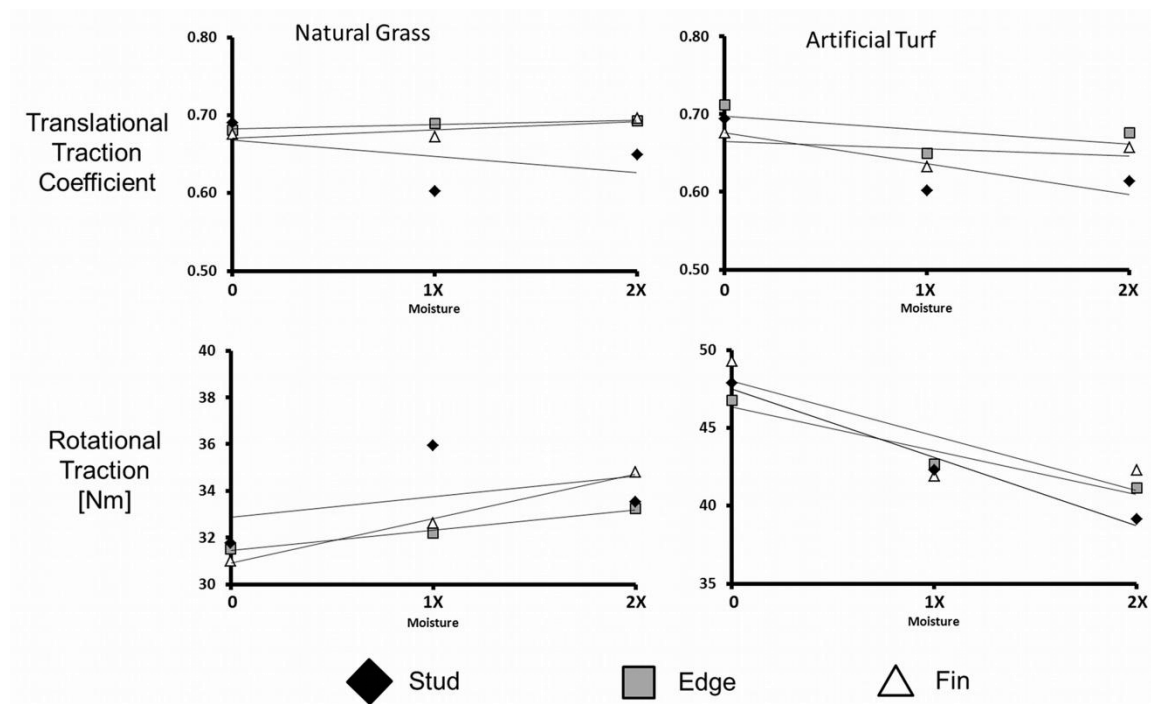

Figure 4-4: Effect of surface moisture on translational (top row) and rotational (bottom row) traction. The left column is traction on the natural grass surface, while the right column is traction on the artificial turf surface.

4.4 Discussion

Footwear traction has been studied for the past 30 years, through various mechanical testing techniques using different normal loads, movement speeds and surface conditions (Torg et al. 1974; Bonstingl et al. 1975; Bowers & Martin 1975; Andreasson et al. 1986; Heidt et al. 1996; Warren 1996; Livesay et al. 2006; Villwock et al. 2009a; Kuhlman et al. 2010). However, due to footwear traction diverging from Amonton's laws of friction, comparisons between studies have been difficult. The purpose of the current study was to

examine how altering normal load, movement speed and surface conditions affect footwear traction.

4.4.1 Normal Load

All shoes tested regardless of surface, displayed a strong, linear, positive correlation between normal load and traction, which supports previous studies (Torg et al. 1974; Bowers et al. 1975; Warren et al. 1996; Liversay et al. 2006). This increase in traction was due to the interaction between the shoe and surface, with greater normal loads causing greater penetration depth of the footwear cleats into the ground, resulting in larger traction values. However, the difference in penetration of the cleats between the shoes was not quantified in the current study.

Although the slopes of the footwear tested were slightly different, the ranking of the shoes did not change as load increased. For example, on grass the stud shoe always had the highest traction values, while the fin shoe always had the lowest. One of the main problems of performing traction tests with large normal loads is that the field, or sample surface receives a large amount of damage during the testing. The fact that the ranking of the shoes stayed constant could allow traction measurements to be conducted at much lower normal loads. Researchers could simply extrapolate their results to more ‘physiologically relevant’ loads, or since the ranking of the footwear was constant, use the results at the lower normal loads.

The results of the experiment could allow for comparisons between studies with similar testing procedures that were conducted using different normal loads by extrapolating the traction curves. It must be stressed that this extrapolation should be used with caution and would only be possible if the linear relationships were known. As well there may be certain normal loads when the relationship fails to be linear (perhaps at extreme high or low loads). Unfortunately no studies in the literature could be found which measured the traction of the footwear tested in this study with similar testing procedures (rotational axis in the forefoot, only forefoot in contact with the ground).

4.4.2 Movement Speed

As the speed of translational movement was increased, a strong, positive, linear correlation was displayed for translational traction for all shoes, regardless of surface. However in terms of rotational traction, increases in the speed of rotation had little effect on traction. There have been a few previous studies which have investigated how movement speed can affect traction (Schlaepfer et al. 1983; Andreasson et al. 1986). These studies showed very shoe specific relationships, where certain shoe-surface combinations resulted in increases in traction as the speed of movement increased, while other combinations resulted in constant traction values as movement speed increased (Schlaepfer et al. 1983; Andreasson et al. 1986). The current study displayed that on grass and artificial field turf, all footwear responded similarly, with an absence of any shoe specific relationships. The differences between results may be due to the testing methods, or the fact that this study measured cleated footwear, while the previous studies measured running shoes, tennis shoes as well as cleated footwear. As well the cleat

design or type of cleat tested was not well documented with previous studies simply referring to the cleated shoes as soccer shoes.

The ranking of the footwear did not change as the speed was altered indicating that comparative results can be acquired when testing at slower speeds that may not necessarily be 'game specific', but may be easier to collect.

4.4.3 Surface Moisture

The surface moisture during footwear traction testing has been thought to affect traction with previous studies showing that increases in moisture results in a vast reduction of footwear traction (Bowers et al. 1975; Heidt et al. 1996). These studies examined the effect of surface conditions on 2nd generation artificial turf surfaces only, which had limited drainage and was more representative of a carpet surface. No current studies could be found investigating the effects of moisture on third generation, in-fill surfaces.

In this study, it was found that the changes in moisture affected the shoes differently, which is supported by results from a thesis, showing differing shoe specific changes in traction as surface moisture was altered on both second generation artificial turf as well as natural grass (Malette 1996).

On grass the stud shoe was greatly affected when 1x moisture was added, having a decrease in translational traction and an increase in rotational traction. As more moisture was added, the stud shoe seemed to 'recover' and return to values similar to the edge and fin shoe. These shoe specific differences seen were due to the different cleat arrangement

of the footwear. The stud shoe, which was characterized by a more uniform sole of smaller rubber cleats, reacted quite differently than the edge and fin shoe, which had a smaller number of much larger cleats. This different reaction was caused by the softening of the soil with the increase in moisture, which allowed the longer cleats to penetrate deeper into the ground. This deeper penetration could have provided a more stable interface, whereas the shorter cleats of the stud shoe were affected by the non-uniformity of the surface to a greater extent, perhaps explaining the sudden ‘jumps’ in traction values.

On the artificial turf surface all three shoes reacted similarly with a decrease in traction with 1x and 2x moisture. The different effect moisture had on the grass and artificial turf surface may be due to the difference in ‘soils’ of each surface. On grass the edge and fin shoe had slight increases in traction as moisture was added, while on artificial turf decreases in traction were witnessed. On natural turf, the soil is composed of tightly packed dirt which is held together by the strong root structure of the grass, while on artificial turf, the surface layer consists of loosely packed rubber pellets. These rubber pellets freely move, and act to facilitate the drainage and runoff of the water when added to the surface (Severn 2010). The majority of water potentially quickly flowed to the underlying sand surface, leaving a small layer of boundary lubrication on the rubber pellets which reduced the traction. While on the grass surface, the soil held the water much better, possibly making a mud type mixture. In addition the root zone may have contributed to hold the water much better.

It is important to note that as the surface conditions changed, the ranking of the footwear also changed, indicating that these shoes react very differently to moisture. The stud shoe was most affected having a vast reduction in translational traction, and the greatest increase in rotational traction as moisture was added, while the fin and edge shoe were affected to a smaller, more predictable extent.

4.5 Conclusion

This study sought to determine how normal load, movement speed and surface conditions affect footwear traction in an effort to better allow for comparisons between studies. Normal load had a linear effect on traction with the ranking of the footwear remaining constant indicating that testing at small normal loads may be sufficient. Movement speed also had a linear relationship for translational traction, but was constant for rotational traction with the footwear rankings remaining constant again indicating that slow speeds may be sufficient for testing. Surface moisture had a large effect on footwear traction and was shoe and surface specific. It is important to note that the relationships listed above are only valid for the method of testing utilized (forefoot contact), as well as for the range of loads and speeds tested. The relationship may fail to remain linear at higher or lower loads or speeds. Future studies may continue to examine the effect that moisture has on footwear traction to better understand how these shoes react to changing conditions.

Chapter Five: Footwear Traction at Different Areas on Artificial and Natural Grass Fields

5.1 Introduction

It has been previously proposed that non-contact injuries in sport may be due to the interaction between the shoe and surface, termed footwear traction (Torg et al. 1974; Heidt et al. 1996; Livesay et al. 2006). Studies have shown that increases in footwear traction lead to an increase in the amount of lower extremity non-contact ACL injury (Lambson et al. 1996) as well as increases in knee and ankle joint loading (Wannop et al. 2010). Obviously sport surface characteristics play a large role in this relationship.

Artificial turf was first used as an alternative to natural turf in 1966, with the first major installation being Texas in the Astrodome. These early turfs are known as first generation, and were made from fibres (usually nylon) densely packed with no shockpad or in-fill between the fibres and ground surface. Second generation products began to appear in 1976 and were categorized by longer fibres with sand used to fill the spaces between the fibres and shockpads being incorporated under the surface. These earlier generations of artificial turf have been attributed to a greater risk and incidence of injury compared to natural grass (Bramwell et al. 1972; Skovron et al. 1990) with the mechanism thought to be due to the increased footwear traction.

While 1st and 2nd generation artificial surfaces more resembled carpet due to their tightly packed fibres and limited in-fill/shockpad, newer 3rd generation surfaces were developed in the 1990's that were composed of less dense, fibrillated fibres which closely mimicked

natural grass due to the addition of an in-fill composed of rubber and/or sand particles. Many facilities have begun to install these 3rd generation in-fill surfaces due to the ability of the surfaces to permit higher usage from greater durability, allow all weather capabilities as well as being labelled as 'low maintenance'.

In terms of 3rd generation surfaces, it has been shown that these in-fill surfaces increase the shoe-surface rotational traction of the athlete (Livesay et al. 2006; chapter 3 of this thesis), however recent studies have reported similar or even a decrease in injuries compared to natural grass (Meyers & Barnhill 2004; Steffen et al. 2007; Meyers 2010). This raises the question as to whether the high footwear traction is the cause of these non-contact injuries or if some other mechanism is at play. One initial thought is that perhaps it is not the magnitude of the higher traction but rather the inconsistencies going from a region of low traction to high traction and vice versa that poses the greatest risk of injury. While no study has examined how an inconsistent surface can affect injury, anecdotally an increase in surface consistency was matched with a dramatic decrease in injury frequency (Nigg 2003). Therefore, the purpose of this study was to compare the footwear traction at various locations on an in-fill artificial turf and natural grass surface. It was hypothesized that artificial turf would be more consistent throughout the field compared to natural grass.

5.2 Methods

Data were collected on three types of footwear, Nike Speed Shark (stud), Under Armour Metal Speed II Low (edge), Nike Air Impact Shark (fin) (Figure 5-1), using a portable

traction testing machine (Figure 3-1, chapter 3). The tester consisted of a stiff base on which a single guide rail was mounted. A load bearing movable platform slid freely on the polished guide rail by means of low friction, linear bearings. The platform incorporated a structure for holding a vertical shaft. The shaft was mounted on bearings so that it could rotate freely. A support at the top of the shaft allows weights to be added. At the bottom end of the shaft, a last and test shoe were attached, with the machine being powered and controlled by a standalone, portable touch-screen computer.

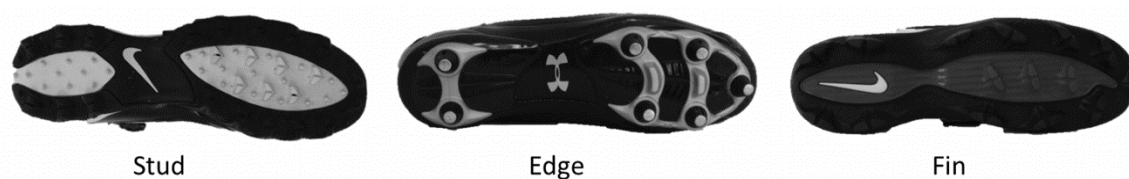

Figure 5-1: Photographs of the shoes tested

For translational traction measurements, a hydraulic ram was attached to the platform. The force transducer recorded the force resisting motion of the carriage. This horizontal force divided by the vertical force was equal to the translational traction between the shoe and playing field. The translational traction tests were conducted along the long axis of the shoe in the forward movement direction. For rotational traction, the vertical shaft was unlocked and free to rotate, with the rotational axis of the tester in line with the forefoot. By unlocking the vertical shaft, the moment generated was determined by multiplying the force measured by the force transducer with the moment arm of the shaft. All rotational tests were performed in the internal rotational direction.

During testing each shoe was placed in 20° of plantar flexion with only the forefoot in contact with the ground. Five trials per shoe-surface condition were collected with the force transducer sampling at a frequency of 2000Hz. For all tests a total normal load of 580N was used, with the tester moving at a speed of 200mm/s, moving a distance of 200mm for translational traction and 90° /s, moving a through 70° for rotational traction. The validity and repeatability of the tester has been confirmed in a previous study (Wannop et al. 2009).

Each shoe was tested at six different locations on both the artificial turf surface, as well as the natural grass football field. The first three locations tested were 5 meters from the sideline (sideline), 15 meters from the sideline (numbers) and at midfield (center) along the 40 yard line. The same three locations were also collected along the 20 yard line (Figure 5-2). The artificial turf surface consisted of the 2.5 inch Duraspine product installed by Fieldturf. The surface contained 4.55 kilograms per square foot of in-fill consisting of 3.19 kilograms of silica sand plus 1.36 kilograms of cryogenic rubber. The infill was installed with an initial base layer of silica sand, followed by 8-10 applications of a silica sand/rubber mixture, finished with a final top layer of larger sized cryogenic rubber particles. The grass surface consisted of Kentucky Bluegrass.

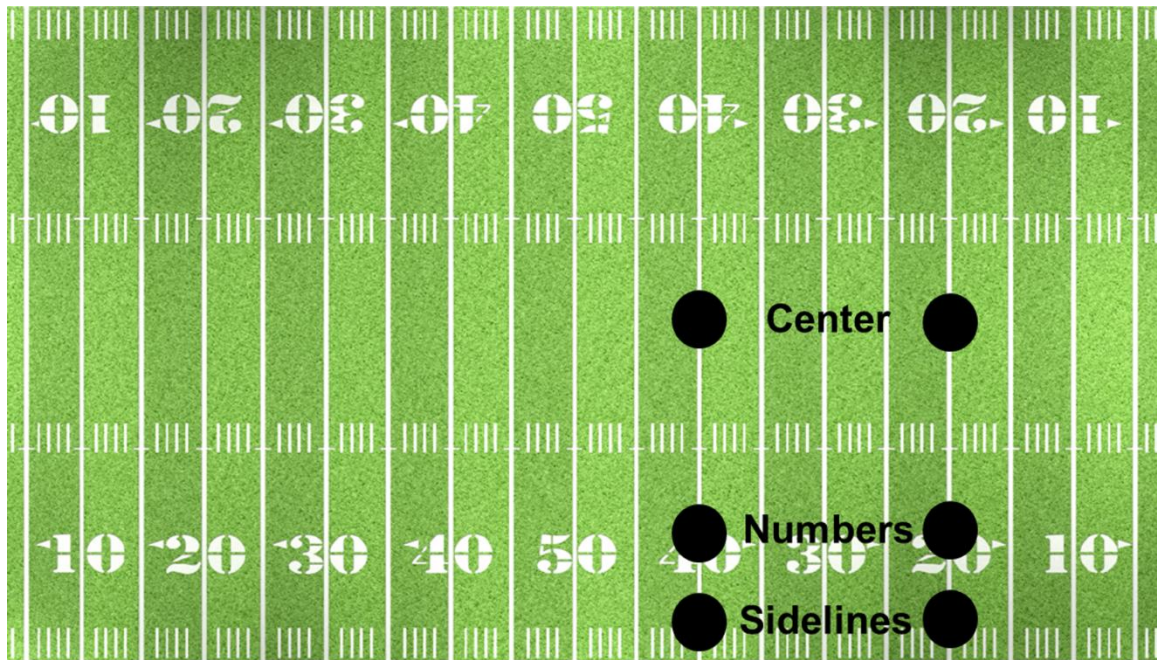

Figure 5-2: Location of the six areas used for traction testing

Measurements on the natural grass were taken at the beginning and end of the season which lasted four months to capture any changes in traction that may result from a wearing down of the field due to use.

Comparisons between locations were completed using a one way ANOVA with SPSS 10 (SPSS Science Inc, Chicago, Ill) with the significance of the comparisons being set at a 95% level of confidence.

5.3 Results

The results of the traction testing on the natural grass and artificial turf at the end of the season can be seen in Figure 5-3 and Figure 5-4 respectively. On grass, as the location of

testing moved away from the center location the general trend was an increase in both translational and rotational traction, with peak traction values being present at the sideline. On artificial turf, the results were a bit more variable, with different shoes responding differently to the change in location, as well as differing results for translational and rotational traction. The effect of wear on the grass surface can be seen in Figure 5-5. The general trend for the data was a vast reduction in traction at the end of the season especially at the center location.

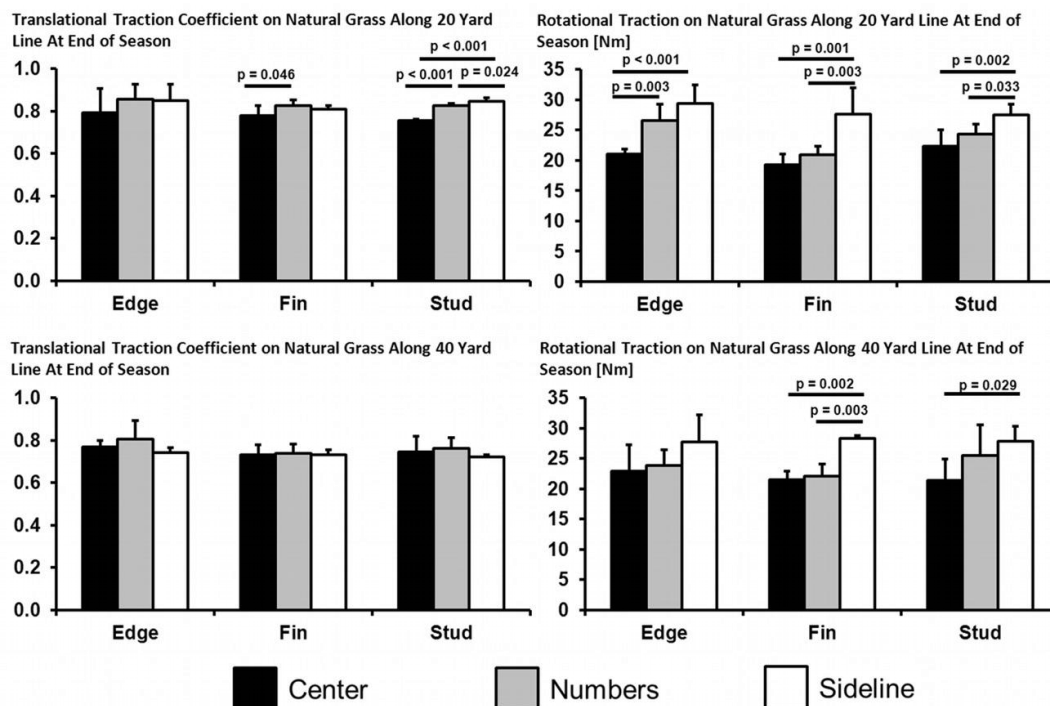

Figure 5-3: Translational and rotational traction of the edge, fin and stud shoe on natural grass at the end of the season along the 20 and 40 yard line.

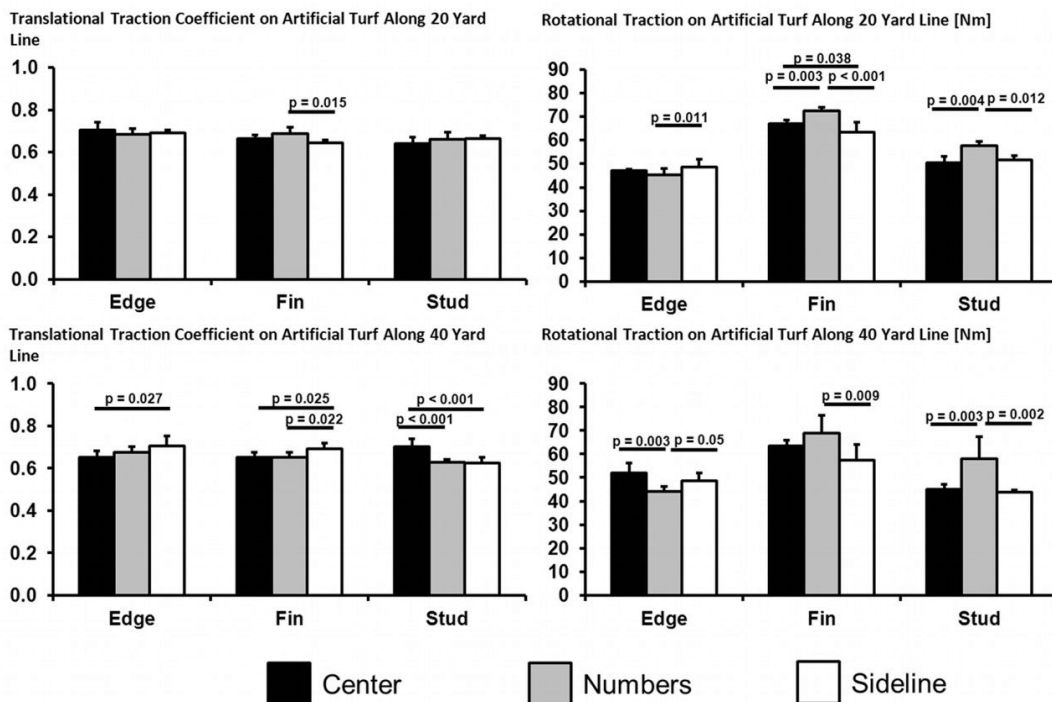

Figure 5-4: Translational and rotational traction of the edge, fin and stud shoe on artificial turf at the end of the season along the 20 and 40 yard line.

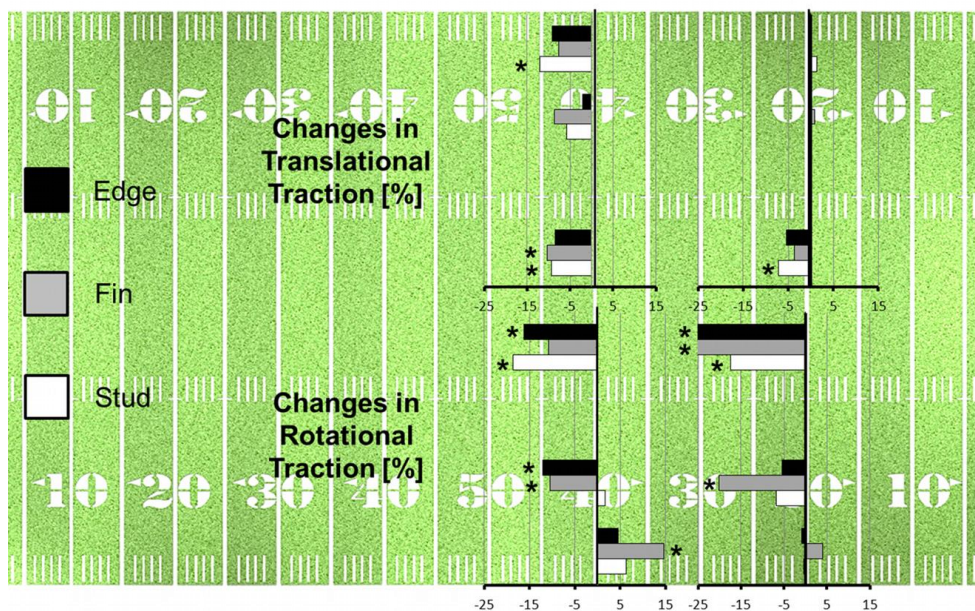

Figure 5-5: Changes in translational and rotational traction along the 20 and 40 yard line on the natural grass field. Negative values indicate a decrease in traction at the end of the season. Significant differences are indicated with an asterisk.

5.4 Discussion

There have been great advancements in artificial turf development in the last decade, with 3rd generation in-fill surfaces having similar characteristics to natural grass. One of the concerns when it comes to artificial turf is the thought that these surfaces lead to an increase in non-contact injuries due to the increase in rotational traction. Recent studies have shown, however, that injury rates may not be increased even though increases in rotational traction are present (Skovron et al. 1990; Meyers & Barnhill 2004; Steffen et al. 2007; Meyers 2010). This raises the thought that perhaps part of the mechanism of these non-contact injuries is from the inconsistent traction existing on a natural grass field and the current study sought to determine if artificial turf surfaces present more consistent traction characteristics across the surface.

On grass, no differences in traction were found along the 20 or 40 yard line at the beginning of the season, indicating that the field was very consistent, offering uniform traction values regardless of location. However, footwear tested on the same field of natural grass at the end of the season displayed large differences in traction. Large differences were seen along both the 20 and 40 yard line, indicating that the field no longer provided uniform traction, with the field conditions changing dramatically as the season progressed. Visually the changes in surface conditions were noticeable, with a large amount of damage occurring specifically at the center position. Centerfield is where the majority of the game is played, which caused the large reductions in traction simply due to wear. Along the 40 yard line the wear and damage of season play had destroyed the grass so the testing was performed mostly on the underlying dirt at the center

position, a mixture of dirt and dead grass at the numbers and mostly healthy grass at the sidelines. Rotational traction has long been thought of as much more dangerous in terms of shoe-surface related injuries (Lambson et al. 1996), and as the season progressed, rotational traction was affected to a greater extent than translational traction. This vast reduction in rotational traction as the season progressed may partly explain the early season injury bias (Orchard 2002), in which football injury studies have reported a greater incidence of injury at the start of the season than at the end of the season when the season is played during the fall months (when the present study was conducted) (Bramwell et al. 1972; Culpepper & Niemann, 1983; Hoffman & Lyman, 1988; Andresen et al. 1989). This reduction in rotational traction on grass may have a protective effect for athletes lowering the loading on the joints and leading to a reduction in injury.

The artificial in-fill turf was expected to be a much more consistent surface compared to grass, which was not the case. The alterations in the traction were due to the movement of the in-fill material as a result of use and wear of the surface, which created regions of high and low traction. Areas of heavy play would experience a large turnover of in-fill material which was seen most notably for rotational traction, at the center and sideline locations. The reduction in traction at the center again was due to the large amount of play in this area of the field, while the decrease in traction at the sideline would be caused by the heavy traffic associated with players exiting and entering the field (as the players bench was located off field at this location). While the artificial turf is swept as part of routine maintenance to redistribute the in-fill material, it is unknown when the last maintenance was performed prior to testing. While the relative changes in traction were

much smaller on the artificial turf than the natural grass, the artificial turf, may in fact pose a higher risk in terms of non-contact injury. On the grass surface, these areas of high and low traction were very visible, while on artificial turf, the surface appeared consistent. If an athlete expects a certain value of traction, but moves into an area of high or low traction on the artificial turf, foot fixation or slipping may occur, which may injure the athlete depending on the severity of the slip or foot fixation.

The consistency of each shoe type may also be important to the athlete when selecting footwear. The athlete will want a shoe that behaves the most consistently on all areas of the field, to allow for reliable performance. Even though the surface changed as the season progressed and there were differing areas of high and low traction at the end of the season, it was speculated that the different types of footwear would behave differently and perhaps some would be able to mitigate these surface changes. The footwear tested were quite different with the edge shoe composed of a smaller number of larger cleats, arranged around the periphery of the sole, the fin shoe had a small number of large blades arranged in various directions, while the stud shoe had a large number of small rubber cleats. It was thought that the edge and fin shoe would provide greater traction on the fresh grass areas of the field by enabling deep penetration of the larger cleats, and that the traction would be heavily affected when testing was conducted in areas with limited or damaged grass surfaces. The stud shoe was expected to behave differently, maintaining its traction to a greater degree on the damaged areas of the field due to the larger number of smaller cleats which would increase the area of contact between the two surfaces. Comparing the traction of the three types of shoes, at the end of the season on grass, all

shoes responded similarly with the general trend of low traction at the center position and increasing as the location was moved closer to the sidelines. On grass, no shoe was able to mitigate the changes in traction over the season or the inconsistencies in traction as testing location changed.

On artificial turf, the greatest effect of changing traction with location was seen in the stud shoe especially along the 40 yard line. A reduction or movement of in-fill material would not affect the edge cleat design to the extent of the stud or fin shoe, since the cleats can penetrate to a much deeper level. The smaller more uniform stud shoe configuration likely had a reduced interaction with the surface, due to the lower penetration or lack of penetration due to in-fill movement. On artificial turf the edge and fin shoe were able to slightly mitigate the changes in surface condition as testing location was changed, however the stud shoe was not.

5.5 Conclusions

The results of the current study indicate that over the course of a season the traction values of a natural grass field change considerably, creating visible areas of high and low traction. This reduction in traction as the season progresses may provide a protective mechanism to athletes late in the season, partially explaining the early season injury bias. Surprisingly the artificial turf surface also had areas of high and low traction due to the movement of the in-fill material during play. Cleat type also had an effect on traction with different types of cleats being affected by changes in surface location to different degrees. Future work may aim to determine how traction values of an in-fill artificial turf

surface change over the course of a season and over a single game, as well as how this change in traction on the field potentially influences non-contact injury.

Chapter Six: Footwear Traction and Lower Extremity Non-Contact Injury

6.1 Introduction

In Canada, the leading cause of injury in adolescents is sport (King et al. 1998), with as much as 78% of these injuries being located in the lower extremity (Emery et al. 2005). Injuries in sport are generally termed as either contact, resulting from contact with another player or non-contact where the injury occurs without contact with another player, possibly resulting from the interaction between the shoe and surface. When examining across all sports, 58% of injuries were found to be due to contact, while up to 36.8% of injuries were thought to be non-contact, with the remaining injuries being unknown (Turbeville et al. 2003; Hootman et al. 2007). It has been long believed that one of the major causes of non-contact injury, especially in gridiron football, is related to the shoe-surface interaction (Torg et al. 1974; Lambson et al. 1996; Pasanen et al. 2008).

Gridiron football is one of the most popular sports for adolescents, being played in more than 14,000 high schools in the United States, with an estimated one million students participating each year (National Federation of State High School Associations 2009). Lower extremity injuries are prevalent in football, with injuries to the ankle and knee joint being by far the most widespread and costly (Powell & Barber-Foss 1999; Turbeville et al. 2003; Fong et al. 2007; Hootman et al. 2007; Nelson et al. 2007). In fact, ankle injuries can represent over 24% of all high school athletic injuries (Nelson et al. 2007) and as much as 76% of all football related injuries (Garrick & Requa 1988). The majority of injuries are sustained by football positions that involve a large amount of maximal effort cutting and pivoting movements, with running backs (26.4% of all

football injuries) and wide receivers (11.6% of all football injuries) being the positions most likely of sustaining an injury (Nelson et al. 2007). Due to these cutting movements, it is of no surprise that even though football is a high impact contact sport, over 36% of all injuries are non-contact in nature (Turbeville et al. 2003).

For the past forty years footwear traction has been thought to be one of the causes of lower extremity injury in sport. Foot fixation was first thought to be affiliated with injury, with work by Torg et al. (1974) being one of the first to publish on the traction of footwear. These authors combined results from previous injury studies, in order to gain further insight into the relationship between footwear traction and injury. The results suggested that athletes who wore a shoe model, which produced lower rotational traction, had a lower incidence and severity of injury over the season.

In a landmark three year prospective study, Lambson et al., (1996) examined the rotational resistance of modern football cleat designs worn at the time and the corresponding incidence of ACL tears in high school football players. Cleats with an Edge design (longer irregular cleats placed at the peripheral margin of the sole with a number of smaller cleats pointed interiorly) had the highest rotational traction and when compared to the athlete injury rate, led to a statistically higher number of ACL tears compared to the group consisting of all other shoes. While this study was the first to examine the link between footwear traction and injury prospectively, it still possessed some limitations. The major limitation was that the actual surface and shoes were not used for rotational traction measurements and only representative sample surfaces and

footwear were used. Studies have shown that substantial differences in traction measurements can result when comparing laboratory testing of sample surfaces to on-field traction testing (Severn et al. 2010). Additionally the results may not have been as strong as initially thought, as all football shoe models did not follow the trend of greater traction leading to a greater incidence of injury.

Unfortunately, in recent years, little work has followed that of Lambson, relating to footwear traction and injury. Regardless, it is still widely thought that rotational traction is an important component of traction in terms of injury. However, the majority of work has examined rotational traction exclusively, completely ignoring translational traction without much justification (Torg et al. 1974; Torg et al. 1996; Livesay et al. 2006; Villwock et al. 2009a; Villwock et al. 2009b). Translational traction provides athletes with the ability to start and stop suddenly as well as to perform certain cutting manoeuvres, which may also place the athlete at risk of foot fixation, causing injury. While the study of Lambson et al., (1996) indicated that high traction may lead to injury, they did not indicate how the risk of injury changed with increasing traction or what amount of traction was safest. Additionally, in the past decade new generations of artificial turfs as well as engineered grasses and soils have been developed, which will affect the footwear traction of athletes but no studies have been conducted along the lines of Lambson on these new surfaces. Research into the actual relationship between an athlete's footwear traction and injury over the entire range of traction actually used in sport is not available. Therefore, the purpose of this study was to determine if a

relationship exists between an athlete's footwear traction and lower extremity non-contact injury.

6.2 Methods

Data were collected over the course of three years at Shouldice Athletic Park in Calgary, Canada. Shouldice Athletic Park is a multiuse facility where all city high school gridiron football games in Calgary are played. Over the course of the three year study, the park converted its fields from all-natural grass to all artificial turf surfaces. During year one, the fields consisted of all grass surfaces, during year two they consisted of 50% grass fields, 50% artificial turf fields and during year three they consisted of all artificial turf fields.

The artificial turf surface consisted of the 6.35cm Duraspine product installed by Fieldturf. The surface was composed of 4.55 kilograms per square foot of in-fill consisting of 3.19 kilograms of silica sand plus 1.36 kilograms of cryogenic rubber. The infill was installed with an initial base layer of silica sand, followed by 8-10 applications of a silica sand/rubber mixture, finished with a final top layer of larger sized cryogenic rubber particles. The grass surface consisted of Kentucky Bluegrass, which had a blade length of 5cm, with the underlying soil consisting of 40% clay, 30% sand and 30% silt.

A total of 555 high school football players from different Calgary area high schools participated in the study. In order to participate, athletes were required to have their parents read and sign a consent form approved by the Universities ethics committee as

well as fill out a baseline pre-season questionnaire (Appendix A). The characteristics of the athletes can be seen in Table 6-1. During each year, footwear of all athletes that participated were tested using a portable robotic traction testing machine (Figure 3-1, chapter 3). The machine consisted of a stiff base on which a single guide rail was mounted. A load bearing movable platform slid freely on the polished guide rail by means of low friction, linear bearings. The platform incorporated a structure for holding a vertical shaft. The shaft was mounted on bearings so that it may rotate freely. A support at the top of the shaft allowed additional mass to be added to the movable platform thereby increasing the normal load during the traction test. Translational and rotational traction measurements were taken using a normal load of 580N, which was found during a previous study, to be the most physiologically relevant load that could be utilized that was both repeatable and caused minimal damage to the field (Wannop et al., 2009). Similarly, it has been shown previously in chapter 3 that the relationship between normal load and footwear traction is highly linear.

Table 6-1. Anthropometrics of the 555 athletes

	Age [years]	Mass [kg]	Height [m]	Experience [years]
Mean	16.3	79.5	1.79	2.5
St. Dev	0.7	14.1	6.9	2.4

At the bottom of the movable platform, a shoe last was attached and was placed in 20° of plantar-flexion. This orientation allowed only the forefoot cleats to be in contact with the ground when the test shoe was attached to the last, which would simulate the foot orientation during a cutting movement. The machine was powered and controlled by a stand-alone, portable touch-screen computer.

For translational traction measurements, a hydraulic ram was attached to the platform and the force exerted by the hydraulic ram was measured using a force transducer. The translational traction tests were conducted along the long axis of the shoe, which is representative of the initial foot plant prior to a cutting maneuver. The platform and the attached mass were moved horizontally along the guide rail at a speed of 200mm/s moving a total distance of 200mm. This speed was selected as it was found to have high repeatability during previous studies and was the maximum speed that could be tested with no residual movement of the testing machine (Wannop et al. 2009). The force transducer recorded the force resisting motion of the platform. This horizontal force divided by the vertical force was equal to the translational traction between the test shoe and playing field.

For rotational traction, the vertical shaft was unlocked and free to rotate, with the rotational axis of the tester being placed in line with the forefoot. The force transducer measured the moment generated around this axis of rotation. The shaft was rotated at a speed of 90°/s.

Three trials per shoe-surface condition were collected with the force transducer sampling at a frequency of 2000Hz. A previous study found the traction tester to have both a high validity and repeatability (Wannop et al. 2009). The mean temperature during the on field traction testing between all testing days was $10.6 \pm 5.4^{\circ}\text{C}$.

For traction testing, all footwear were collected from the athletes after a practice at the start of the season. The shoes were labelled and the brand, make, model, size and mass of the shoe were recorded with photographs taken. The shoes were transported and tested at Shouldice athletic park during the next day and returned to the team before the start of their next practice. During year one, the shoes were only tested on the natural grass surface, during year two all traction tests were conducted on both the natural grass and the artificial turf surface and during year three tests were conducted on the artificial surface.

Over the course of each year, data on all injuries of the athletes were recorded by certified athletic therapists on site at the athletic field. While the definition of injury lacks universal agreement (Prager et al. 1989), in this study a reportable injury was defined as any game-related football trauma that resulted in an athlete missing all or part of a game, any time away from competition as well as any injury reported or treated by the athletic trainer similar to the studies of Meyers et al., (2004, 2010). When an injury occurred, the athletic therapist immediately recorded the history (what caused the injury, whether it occurred as a result of contact or non-contact), any additional observations, as well as the results of any functional, special tests performed (Appendix B). In addition, the outcome of the injury was recorded as well as the length of time the athlete was inactive (not participating in any games or practices) by practice participation forms filled out by trainers present at all team practices (Appendix C).

For analysis, individual athlete injury data that was deemed to be due to a non-contact event were combined with the individual athlete footwear traction data. For traction data, the static peak translational traction coefficient and peak rotational moment were used to define the translational and rotational components of traction for each athlete. The effect of each surface on non-contact, lower extremity injury was first compared using a chi-squared test with a Yates correction for continuity at a significance level of 0.05. The injury rate was calculated as the number of injuries per 1000 game exposures, to allow for comparison between previous studies (Powell & Barber-Foss 1999; Turbeville et al. 2003; Shankar et al. 2007) and 95% confidence intervals were estimated using a Poisson regression. If no difference in lower extremity non-contact injury rate was found between surfaces, data from all surfaces would be combined and divided into three groups depending on their footwear traction, with each group populated by an equal number of athletes. The number of injuries was compared between the three groups using a chi-square test with a Yates correction, with significance being detected at a level below 0.05, with 95% confidence intervals of injury rates being estimated using a Poisson regression.

6.3 Results

The breakdown of all 58 lower extremity non-contact injuries can be seen in Table 6-2. Ligament sprains represented the greatest percentage of the lower extremity non-contact injuries containing over 67% of all injuries, followed by muscle strain/spasm at 19% and ligament tears at 2.5%.

Table 6-2. Breakdown of all non-contact lower extremity injuries.

Primary Type of Injury	Number of Injuries	% of Total Injuries
Ligament Sprain	39	67.2
Muscle Strain/Spasm	11	19.0
Ligament Tear	3	5.2
Fracture	2	3.4
Muscle Tear	1	1.7
Tendon Sprain	1	1.7
Hyperextension	1	1.7

The majority of injuries occurred at the knee and ankle accounting for over 79% of all reported injuries (27.6% in the knee and 51.7% in the ankle). The locations of all the 58 lower extremity, non-contact injuries is reported in Table 6-3.

Table 6-3. Location of non-contact lower extremity injuries.

Location of Injury	Number of Injuries	% of Total Injuries
Ankle	30	51.7
Knee	16	27.6
Thigh	9	15.5
Foot	2	3.4
Shank	1	1.7

The number of lower extremity, non-contact injuries, exposures and injury rate on each surface can be seen in Table 6-4. There were a total number of 58 injuries recorded, with 36 injuries on the artificial turf and 22 injuries on the natural grass surface. No difference in the number of injuries were seen between the two surfaces ($p=0.066$). The total injury rate of both surfaces was 13.7 (95% CI = 10.2-17.2) injuries per 1000 game exposures. When broken down by surface, the injury rate on artificial turf was 14.8 (95% CI = 10.0-

19.6) injuries per 1000 game exposures compared to 12.2 (95% CI = 7.1-17.3) injuries per 1000 game exposures on natural grass with no significant differences seen between the surfaces.

Table 6-4. Number of injuries, game exposures and injury rate on the artificial turf and natural grass surfaces.

Surface	Number of Injuries	Number of Game Exposures	Injuries per 1000 Game Exposures (95% CI)
Artificial Turf	36	2436	14.8 (10.0-19.6)
Natural Grass	22	1804	12.2 (7.1-17.3)
Total	58	4240	13.7 (10.2-17.2)

Since there were no difference in terms of lower extremity non-contact injury rate due to the surface, all data was combined and divided into three groups populated by an equal number of athletes. Results of the non-contact lower extremity injuries divided into the three traction groups can be seen in Table 6-5 and Figure 6-1.

Table 6-5. Number of injuries, exposures and corresponding injury rate when athletes were divided into three equal groups based on their footwear traction.

	Traction	Non-contact, Lower Extremity Injuries	Number of Game Exposures	Injuries per 1000 Game Exposures (95% CI)	Number of Athletes	Injury Rate
Translational Coefficient	0.480-0.685	19*	1415	13.4 (7.4-19.5)	177	10.7
	0.686-0.719	31 [#]	1428	21.7 (14.1-29.3)	177	17.5
	0.720-0.970	7 ^{**}	1497	4.7 (1.2-8.1)	177	4.0
Rotational [Nm]	15.0-30.9	6 ^{**}	1417	4.2 (0.9-7.6)	184	3.3
	31.0-38.9	24*	1364	17.6 (10.6-24.6)	184	13.0
	39.0-54.9	28 [#]	1459	19.2 (12.0-26.3)	183	15.3

CI = Confidence Interval

*, # represent significant differences ($p < 0.05$) as determined by the chi-squared test.

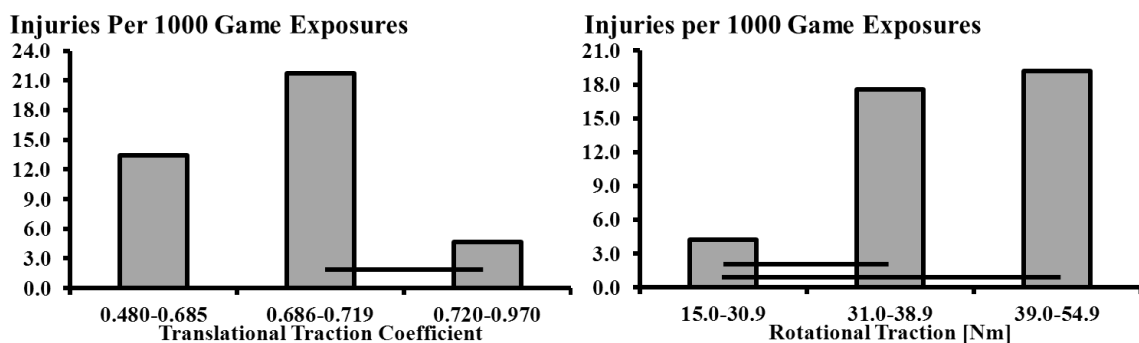

Figure 6-1. Effect of translational (right) and rotational (left) traction on the non-contact, lower extremity injuries per 1000 game exposures. Black horizontal lines represent significant differences.

Significant differences in injury were present for both translational and rotational traction groupings ($p < 0.001$). For translational traction, injury rate reached a peak of 21.7 injuries per 1000 game exposures within the range of 0.686-0.719, before decreasing to 4.7 injuries per 1000 game exposures in the range 0.720-0.970. For rotational traction, there was a steady increase in injury rate as footwear traction increased, starting at 3.3 injuries per 1000 game exposures at 15.0-30.9 Nm, and reaching 19.2 injuries per 1000 game exposures at 39.0-54.9 Nm.

The traction data were tested for skewedness and kurtosis from the normal distribution. Rotational traction showed no skewedness or kurtosis effect, however, translational traction displayed a large kurtosis effect (9.164). The data were also examined for effect size using the methods of Cohen (1992). From the results of this test it was determined that there was a large effect size (0.5) and the sample size contained in the experiment was adequate.

The severity of injury for each group can be seen in Table 6-6. Mild injuries were defined as injuries less than 7 days in duration, moderate were between 7 to 20 days in duration, while severe injuries were greater than 20 days in duration or season ending injuries. In terms of the translational traction groups, the low traction grouping (0.480-0.685) had the greatest percentage of severe injuries, with the mid traction group (0.686-0.719) having the largest number of mild injuries and the high traction group (0.720-0.970) having the greatest number of moderate injuries. Examining the results when grouped by rotational traction, the low traction grouping (15.0-30.9 Nm) had the largest percentage of moderate injuries, while the mid traction group (31.0-38.9 Nm) had the largest amount of mild, and the high traction group (39.0-54.9 Nm) had the highest amount of severe injuries.

Table 6-6. Severity of injury of the three groups [% of total injuries]

	Type of Injury	Traction Grouping		
		Low	Mid	High
Translational Coefficient	Mild	60.9	80.0	50.0
	Moderate	21.7	8.0	33.3
	Severe	17.4	12.0	16.7
Rotational [Nm]	Mild	33.3	69.2	65.4
	Moderate	50.0	23.1	11.5
	Severe	16.7	7.7	23.1

6.4 Discussion

The majority of research on footwear traction and injury has examined rotational traction exclusively, completely ignoring translational traction without much justification. Moreover, the previous studies that have examined the relationship between footwear rotational traction and injury used sample shoes and surfaces for their traction

measurement with only a small range of traction tested. Studies have shown that substantial differences in traction measurements can result when comparing laboratory testing of sample surfaces to on-field traction testing (Severn et al. 2010). Research into the actual relationship between an athlete's footwear traction and injury over the entire range of traction actually used in sport is not available. Therefore the purpose of this study was to determine if a relationship exists between an athlete's footwear traction and lower extremity non-contact injury.

6.4.1 Injury

When comparing overall non-contact injury rate, regardless of surface or traction group, a rate of 13.7 injuries per 1000 game exposures was observed. Comparisons to previous studies are difficult due to the fact that not all studies reported the mechanism of the injury. Some previous studies on American Football reported injury rates of 25.8 injuries per 1000 game exposures (Powell & Barber-Foss 1999), 11.8 injuries per 1000 game exposures (Shankar et al. 2007) and 12.8 injuries per 1000 game exposures (Turbeville et al. 2003). These previous studies did not differentiate between the type of injury (contact or non-contact), and the current study had much higher injury rates than the aforementioned studies. However, it is important to note that the majority of previous studies defined an injury only if the athlete was unable to participate for a full practice or game after requiring medical attention, while the current study collected data on all injuries that required treatment by the athletic therapist, owing to the recent thought that omitting these injuries leads to underreporting and that these minor injuries may lead to major injuries (Dvorak et al. 2000; Meyers & Barnhill 2004; Meyers 2010). In this

context, the higher injury rate of the current study was expected and seems to be within the realm of the previous reports.

6.4.2 Surfaces

While it was not the primary measure of the study, the methodology employed allowed the effect of each surface (natural grass vs. artificial turf) to be compared in terms of injury rate. There was no difference in the number of injuries or the injury rate between the artificial turf and natural grass surfaces. In the literature there have been conflicting outcomes regarding the effect the surface can have on injury. Research on first and second generation artificial surfaces had much more definitive results, with virtually every study showing an increased risk of injury on these early artificial surfaces compared to natural grass (Bramwell et al. 1972; Adkison & Requa 1974; Keene & Narechania 1980; Powell & Schootman 1992). When comparing recent studies on third generation artificial turf surfaces and natural grass the results have been inconclusive. A number of studies have also concluded that artificial turf can increase injury risk (Meyers & Barnhill 2004; Fuller et al. 2007), while other studies claim there is no difference in injury risk between surfaces (Steffen et al. 2007; Ekstrand et al. 2006; Meyers 2010). While none of these studies focussed on non-contact lower extremity injury, the results of the current study provide support to the notion that there are no differences in injury rates between current third generation artificial turf surfaces and natural grass on non-contact, lower extremity injuries in Canadian high school football.

6.4.3 Traction

When examining rotational traction, the trend that increasing traction led to increases in injury supported previous research (Lambson et al. 1996). Low rotational traction footwear (below 30.9 Nm) was associated with a much smaller rate of injury than the mid (31.0-38.9 Nm) and high (39.0-54.9 Nm) rotational traction footwear. As rotational traction increased, the rate of lower extremity non-contact injury increased significantly. The mid traction footwear increased injury rate 319% and the high traction footwear increased injury 357%, as compared to the low traction footwear. This result draws attention to the fact that for the lowest risk of sustaining a lower extremity non-contact injury, the athlete should have rotational traction as low as possible. While this trend of low rotational traction reducing injury risk has been shown previously, this is the first study to display this result for all non-contact lower extremity injuries, not just ACL injury.

In comparison to rotational traction, increases in translational traction did not result in a significant increase in the injury rate. The low traction group had no difference in injury rates (below 0.685), while the mid translational traction group (0.686-0.719) raised the injury rate 362% compared to the high traction group (0.720-0.970). This is interesting especially considering this mid traction grouping includes such a small range of traction values. This result indicates that elements of translational traction may also play a role in terms of injury.

When the severity of the injury was compared for the two groups, some additional information was obtained. It appears that at high translational traction, a large percentage of moderate injuries occurred, while at mid traction ranges (which had the highest injury rate) the largest percentage of mild injuries occurred. Even though the high translational traction group had the lowest injury rate, the majority of these injuries were moderate to severe in nature, making the conclusion for translational traction difficult. This result raises the question as to whether an athlete would want a shoe associated with a high risk of injury, with the high likelihood of the injury being mild, or would the athlete want a shoe with a lower risk of injury, but with the likelihood that if they get an injury it would be moderate to severe in nature.

In terms of rotational traction, the injury severity gave a much clearer picture with the high traction group getting the largest percentage of severe injuries. The high injury rate of this group in addition to the fact that out of the three groups it had the largest percentage of severe injuries provides strong evidence that athletes should avoid wearing footwear in this range of rotational traction if possible.

Although the results of the study indicate that mid translational and high rotational traction were associated with increased injury risk, the mechanism of this increased risk of injury is still unknown. It has been previously shown that increases in traction lead to increases in joint moments of the knee and ankle joint (Wannop et al. 2010), which is believed to be an indication of the loading the joint experiences (Hurwitz et al. 1998). However, in the previous study increases in traction were facilitated by increases in both

the translational and rotational traction of the footwear tested. No information could be gathered regarding how translational traction and rotational traction separately influence joint loading. Similarly the effects of each component of traction on injury in the current study is still unknown, as it is unclear whether the translational traction, rotational traction or some combination of translational and rotational traction caused the increased injury rate for specific groups.

It has long been believed that a relationship exists between the two components of traction with an increase in one component causing an increase in the other component (Wannop et al. 2010). Intuitively this makes sense, as rotational traction is simply elements of the shoe translating in a circular path. However, the footwear tested in the current investigation appears vastly different than the cleated footwear tested in previous investigations. In these previous studies the cleat pattern consisted mostly of studs around the periphery of the shoe sole, or a simple uniform cleated pattern on the shoe sole. In the current investigation, while some shoes remained similar to these earlier models, the majority have changed to include many secondary traction elements. Some of these traction elements are directional in nature, which may explain the decoupling of the translational and rotational traction. Figure 6-2 shows the correlation of translational and rotational traction using data from all 555 tested shoes in the current investigation.

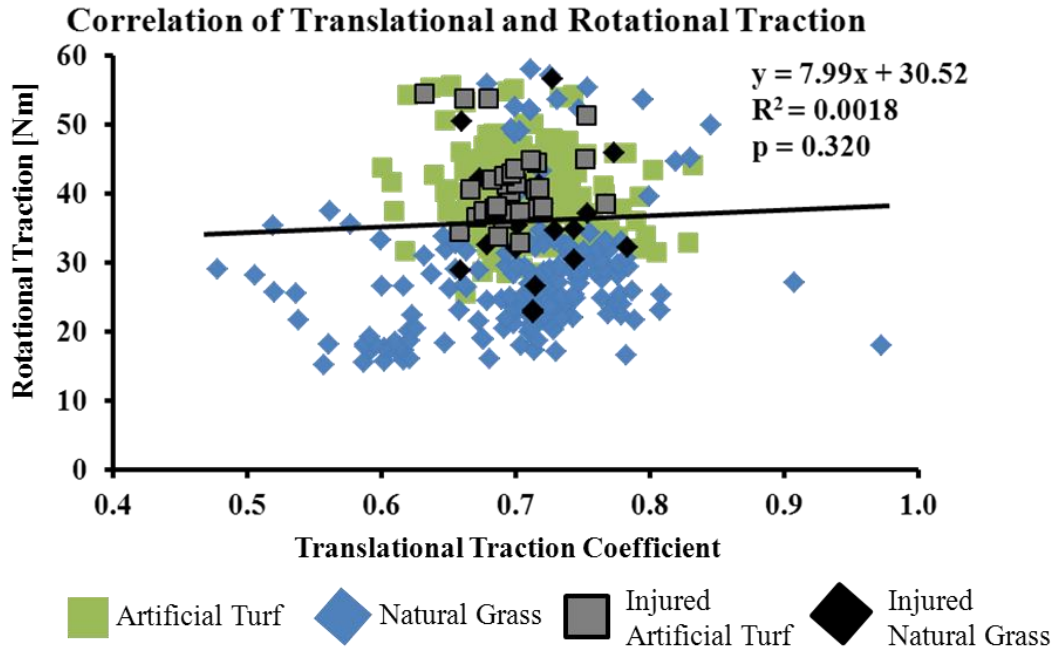

Figure 6-2. Correlation of Translational and rotational traction.

The figure shows that a wide range of translational traction is available on both artificial turf and natural grass, as translational traction on both the artificial turf and natural grass span over a wide range of values. However, there is a much smaller range of rotational tractions available for natural grass than artificial turf. The majority of the artificial turf rotational traction data were located on the upper half of the graph, while the natural grass rotational traction data were located on the lower half of the graph. Identifying the injured athletes, the majority were clumped in an area, which was located in the upper half for rotational traction, and in the mid-range of translational traction.

No significant correlation could be found between rotational and translational traction. For the translational traction values in the mid group of testing, the corresponding

rotational values varied from 16Nm to 54Nm. This shows that translational and rotational traction can change independent of one another and creates the potential to develop footwear that encompasses high components of one type of traction while keeping the other component low. If the component of traction (translational or rotational), that places the athlete at a greater risk of injury is identified, then this component could be altered to produce safer footwear. The next chapter of this thesis is focussed on determining which component of traction (translational or rotational) is associated with this increased risk of injury. By developing footwear with high components of translational traction and low rotational traction and vice versa, the effect of each component of traction on joint loading and injury risk could be determined.

6.5 Conclusion

The results of the current study indicate there is a relationship between footwear traction and non-contact lower extremity injury risk, with increases in rotational traction leading to a greater injury rate. As well, a mid-range of translational traction produced an increase in injury rate. The exact mechanism for this increase in injury rate is unknown; however we postulate it is related to increases in traction causing increases in joint loading. Future studies (Chapter 7) are focused on determining how each component of traction (translational and rotational) individually affects joint loading.

It is recommended that athletes consider selecting footwear with the lowest rotational traction values for which no detriment in performance results as well as to avoid the mid-range of translational traction values.

Chapter Seven: The Effect of Translational and Rotational Footwear Traction on Lower Extremity Joint Loading

7.1 Introduction

In sport, the knee and ankle joint are two of the most common injury sites, with the majority of these injuries being non-contact in nature (Myklebust et al. 1998; Powell & Barber-Foss 1999; Fong et al. 2007). It has been long thought that part of the cause of these non-contact lower extremity injuries was due to the interaction of the shoe and surface, termed footwear traction (Torg et al. 1974; Heidt et al. 1996; Lambson et al. 1996; Livesay et al. 2006). Footwear traction is generally categorized by both a translational and a rotational component. The translational component is defined as the ratio of horizontal force to normal force and is important for starting and stopping during athletic performance. Rotational traction is defined by the moment of rotation with respect to the centre of pressure (Nigg & Yeadon 1987), which refers to rotation of the foot around a point of contact on the shoe sole (Frederick 1986).

Previous studies have investigated the link between footwear traction and non-contact injury. A landmark study by Lambson (1996), where the rotational traction of several popular shoe models were measured, followed by data collected on the incidence of ACL injury in high school football, showed that as rotational traction increased, the number of ACL injuries also increased. In addition, chapter 6 of this thesis indicated that increases in rotational traction lead to increases in non-contact lower extremity injury in high school football players, however, a relationship was also present between translational traction and injury, which has not been shown in previous studies. The majority of past

studies have focussed solely on rotational traction and how it relates to injury completely ignoring translational traction without much justification (Torg et al. 1974; Lambson et al. 1996). Based on the results of chapter 6 translational traction is associated with injury and should not be ignored.

While these previous studies have provided evidence that a link exists between an athlete's footwear traction and injury, the mechanism as to why increased footwear traction can lead to injury remains somewhat unknown. It is generally thought that increased joint loading may lead to joint injury (Sharma et al. 1998; Hewett et al. 2005; Stefanyshyn et al. 2006; Shin et al. 2009). In biomechanics research, joint loading is measured as the peak joint moments, which represent the maximal torque or twisting loading on the joint, and joint angular impulse, which represents the cumulative loading experienced by the joint throughout the stance phase (calculated as the integral of the resultant joint moment vs. time curve). While joint moments and angular impulse calculated from inverse dynamics cannot determine the exact loading on the actual joint structures, it has been used as a valid predictor of the total load across a joint (Hurwitz et al. 1998; Thorp et al. 2006).

Previous research has provided some insight in the link between footwear traction and joint loading, as a study by Wannop (2010) presented results indicating that increases in footwear traction lead to increases in the resultant joint moments of the knee and ankle joint. One drawback of this study is due to the fact that the increases in traction included

both increases in translational and rotational traction, making conclusions regarding which component of traction was associated with increased joint loading impossible.

Previous studies have linked footwear traction to lower extremity non-contact injury, however, these studies mostly focussed on rotational traction. While studies have pointed to the fact that increases in traction lead to increases in joint loading, represented by joint moments, these studies failed to determine how the individual components of traction affected joint loading. Additionally, the influence of translational traction in terms of injury and joint loading remains unknown. Therefore the purpose of this study was to investigate how each component of traction independently affects lower extremity joint moments in order to gain insight into the injury mechanism regarding lower extremity non-contact footwear traction related injuries.

7.2 Methods

7.2.1 Traction Testing

In order to quantify the outsole traction, a six degree of freedom robotic testing machine was used, which consisted of a movable platform stationed under a rigid steel frame. A 60x90cm box was filled with a sample piece of artificial turf (Fieldturf), to the manufacturer's specifications, which was composed of the 2.5 inch Duraspine product being filled with 4.55 kilograms per square foot of infill consisting of 3.19 kilograms of silica sand plus 1.36 kilograms of cryogenic rubber. The box was bolted to the movable platform of the robotic testing machine and a prosthetic foot, was fitted with a right size 10 shoe. The shoe and foot were then attached to the framing of the robotic testing

machine and angled at 20 degrees of plantarflexion in order to simulate the orientation of a foot during a cutting maneuver (Figure 7-1). A triaxial load cell was used to measure forces and moments in all three orthogonal directions during testing.

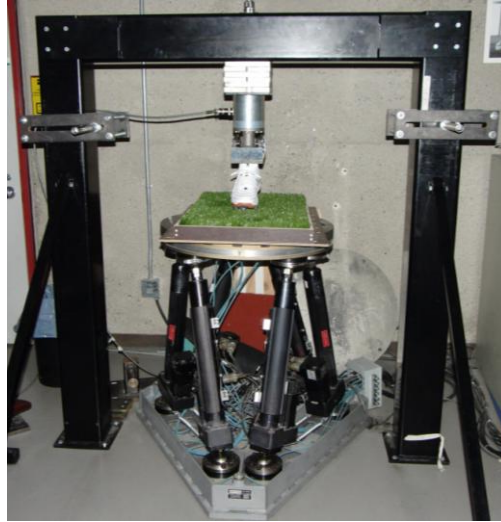

Figure 7-1. Photograph of the robot testing machine used to test the translational and rotational traction of the footwear.

For translational traction testing, a normal load of 650N was first applied to the shoe. After the normal load had been reached, the platform moved anteriorly to the shoe at a speed of 200mm/s, with the horizontal and vertical forces being measured by the load cell during the movement. The translational traction coefficient was calculated as the ratio of horizontal force to normal force, with the peak static value being compared between conditions.

For rotational traction, a normal load of 650N was applied to the shoe and the platform was internally rotated at a speed of 75 °/s, while the load cell collected force and moment data. The movable platform was oriented so that the point of rotation was set at the centre

of the forefoot on the shoe sole. The peak moment of rotation about the vertical axis of the shoe was defined as the rotational traction of the shoe.

For both traction tests, data were collected at a sampling frequency of 1000Hz during the movement. A new area of the turf was used for testing each trial. A total of five trials were performed on each shoe condition and the mean value of these five trials was used in analysis.

7.2.2 Footwear

In order to investigate the effect of independent alterations of translational and rotational traction, custom cleated footwear was created. The footwear was built using three size 10 Starter Smash shoes and attaching different types of cleats to different locations on the shoe sole. First, a reference or control condition was created by attaching 7 aluminumstollen metal cleats (Figure 7-2) to the shoe sole forefoot. One cleat was placed in the center position of the forefoot and 6 additional cleats were placed around this center position in equal 55mm increments (Figure 7-3). To rigidly attach the cleats to the shoe, holes were drilled through the sole and midsole of the shoe. Bolts were placed and glued into the midsole of the shoe and the cleats were then screwed into these bolts. Black athletic tape was placed over all other areas of the forefoot shoe sole, in order to attain a more uniform shoe sole between conditions. The translational and rotational traction of this reference footwear condition were measured using the method described above. This footwear condition termed as the control condition (Table 7-1).

Next, a condition was created that had a reduction in the rotational traction, while keeping the translational traction consistent. An identical number of aluminumstollen metal cleats were attached to a new pair of shoes in the same manner as outlined above; however, the placement of the cleats was altered in order to achieve a reduction in rotational traction. A previous study has shown that by reducing the stud spacing by 50%, a reduction of rotational traction of over 50% can be achieved (Severn et al. 2010). Therefore, the placement of the peripheral studs were moved a distance of 28mm closer to the central cleat, thereby reducing the moment arm of the cleats (Figure 7-3). The translational and rotational traction of the footwear were measured and the condition was found to have similar translational traction values as the control, but much lower rotational traction values (Table 7-1), thus this condition was termed low rotation.

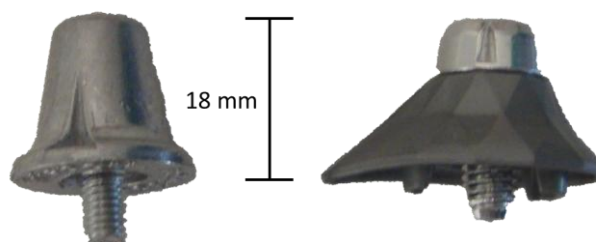

Figure 7-2. Photographs of the two different types of cleats used: adidas aluminumstollen (left), and F50 Tunit (right).

Table 7-1. Traction values of the three test shoes. Values represent the mean of five trials with standard deviation. Bold values represent a significant difference from the control condition.

	Translational Traction Coefficient	Rotational Traction [Nm]
Low Rotation	0.79 (0.03)	18.1 (1.3)
Control	0.77 (0.02)	30.0 (2.5)
High Translation	1.10 (0.02)	31.1 (2.6)

Lastly, footwear was created that maintained similar rotational traction as the control, but had an increase in the translational traction. For this condition, different cleats were attached to the shoe sole, adidas F50 tunit studs instead of the adidas aluminumstollen studs (Figure 7-2). These cleats had the same height as the adidas aluminstollen, however they possessed some directionality and were oriented orthogonal to the direction of motion, in order to increase the surface area resisting the translational movement, in the same locations as the control condition (Figure 7-3). After the translational and rotational traction were measured, it was found that this condition had consistent rotational traction values as the control, but had much higher translational traction values (Table 7-1), therefore, this condition was termed high translation.



Figure 7-3. Photographs of the three footwear conditions, control (top), low rotation (middle) and high translation (bottom).

7.2.3 Motion Analysis

Data were collected on 10 recreational athletes in order to determine the effect that each footwear condition had on the resultant joint loading. The subjects had an average mass of 77.2 ± 6.1 kg and height of 1.78 ± 0.08 m. Before the study all subjects were required to read and sign a subject consent form approved by the university ethics committee. To be included in the study all subjects had to be involved in recreational sport, free from recent lower extremity injury, and properly fit the size 10 shoes.

All subjects were required to perform two movements in the three different shoe conditions in a laboratory setting. The first movement, termed the v-cut, consisted of each subject performing a 90° cut, with the change in direction occurring on the force platform. Each subject performed the movement by running forward at a 45° angle relative to the force platform, planting their right foot in the centre of the force platform and cutting out to their left at a 45° angle (Figure 7-4). The second movement was termed the s-cut and consisted of each subject performing a 315° cut, with the change in direction occurring on the force platform. Each subject performed the movement by running forward, planting their right foot in the centre of the force platform and cutting out to their left anterior side at a 315° angle (Figure 7-4).

During each movement, 3D force data were collected using a force platform (Kistler AG, Winterthur, Switzerland) mounted in the centre of the runway floor. The box containing the field turf sample surface that was used during traction testing was securely attached to the force platform. Additional artificial turf surface was laid along the path of motion

along the lab runway, with EVA foam placed under the artificial surface in order to achieve a similar height to the boxed surface on the force platform.

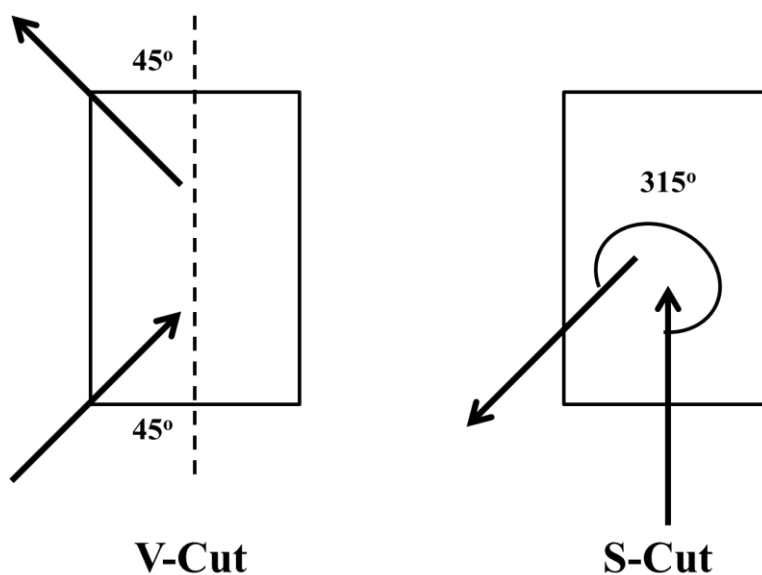

Figure 7-4. Diagram of the V-cut (left) and S-cut (right).

Force data were collected at 2400Hz, and subjects were required to land and perform the cut with their right foot in the center of the force platform. The subjects were instructed to perform each movement at their maximum effort, which was monitored using photocells placed 1.9 meters apart. The subjects were given enough practice trials before testing to ensure proper movement technique, and to determine each subject's maximum speed. Five accepted trials were required with a trial being accepted if the subjects were within 5% of their previously recorded maximum speed in each shoe condition. Three dimensional kinematics of the lower limb were collected for the right leg of each subject during testing. The shoe and shank were defined by attaching retro-reflective markers, measuring 19mm in diameter, to each segment using double sided tape. Three markers

per segment were used, attached to the following locations: head of the fibula, upper tibial crest, distal lateral lower leg, posterior shoe heel, distal shoe heel, lateral side of the shoe below the lateral malleolus. Seven high-speed digital video cameras (Motion Analysis Corp., Santa Rosa, CA) sampling at a frequency of 240Hz were used to capture the motion of the markers. The system was calibrated to an accuracy defined by a 3D residual below 0.6mm.

A standing neutral trial was captured using the video system to determine the 3D coordinates of the ankle and knee joint centre. The subject was asked to stand with their feet hip width apart, with the knee and hip fully extended. In order to determine the ankle joint centre, additional markers were placed on the medial and lateral malleoli. For the knee joint centre additional markers were placed on the lateral knee and at the centre of the patella.

The kinematic and kinetic data were imported into Kintrak 7.0.25 (University of Calgary, Calgary, CA) for analysis, and filtered at cutoff frequencies of 12Hz and 100Hz, respectively, using a fourth order low pass Butterworth filter. The analyzed variables for each shoe condition were peak internal resultant joint moments and peak angular impulses in all three planes using an inverse dynamics approach.

7.2.4 Statistical Analysis

Data were compared using a paired t-test at the 95% level of confidence. All comparisons were made relative to the control condition.

7.3 Results

Horizontal ground reaction force data during the v-cut and s-cut can be seen in Figure 7-5 and Figure 7-6 respectively. During both movements, only the lateral ground reaction impulse was significantly different, with the high translation shoe having a larger impulse than the control ($p=0.024$ both for the v-cut and s-cut). No other differences were seen in terms of peak ground reaction force or impulse.

V-Cut

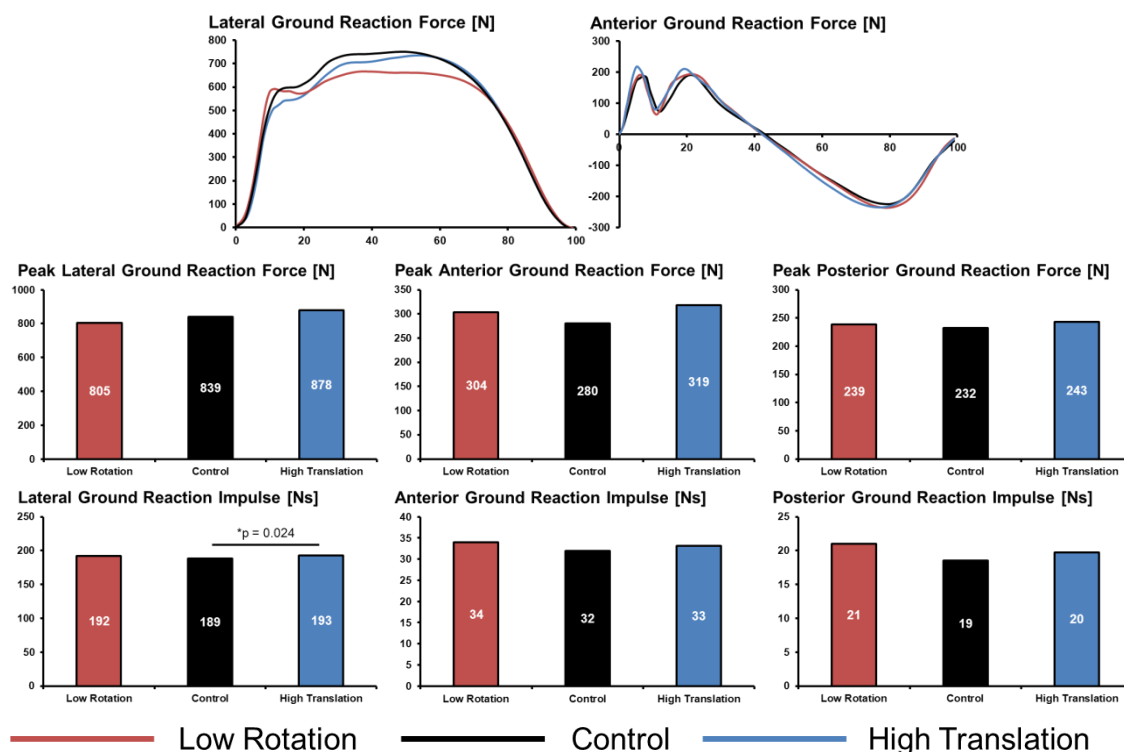

Figure 7-5. Horizontal ground reaction force traces (top row), peak horizontal ground reaction force (middle row) and horizontal ground reaction impulse (bottom row) during the stance phase of the v-cut for the three footwear conditions. Data represent the average values from all subjects, with data being normalized from touchdown to toe off.

S-Cut

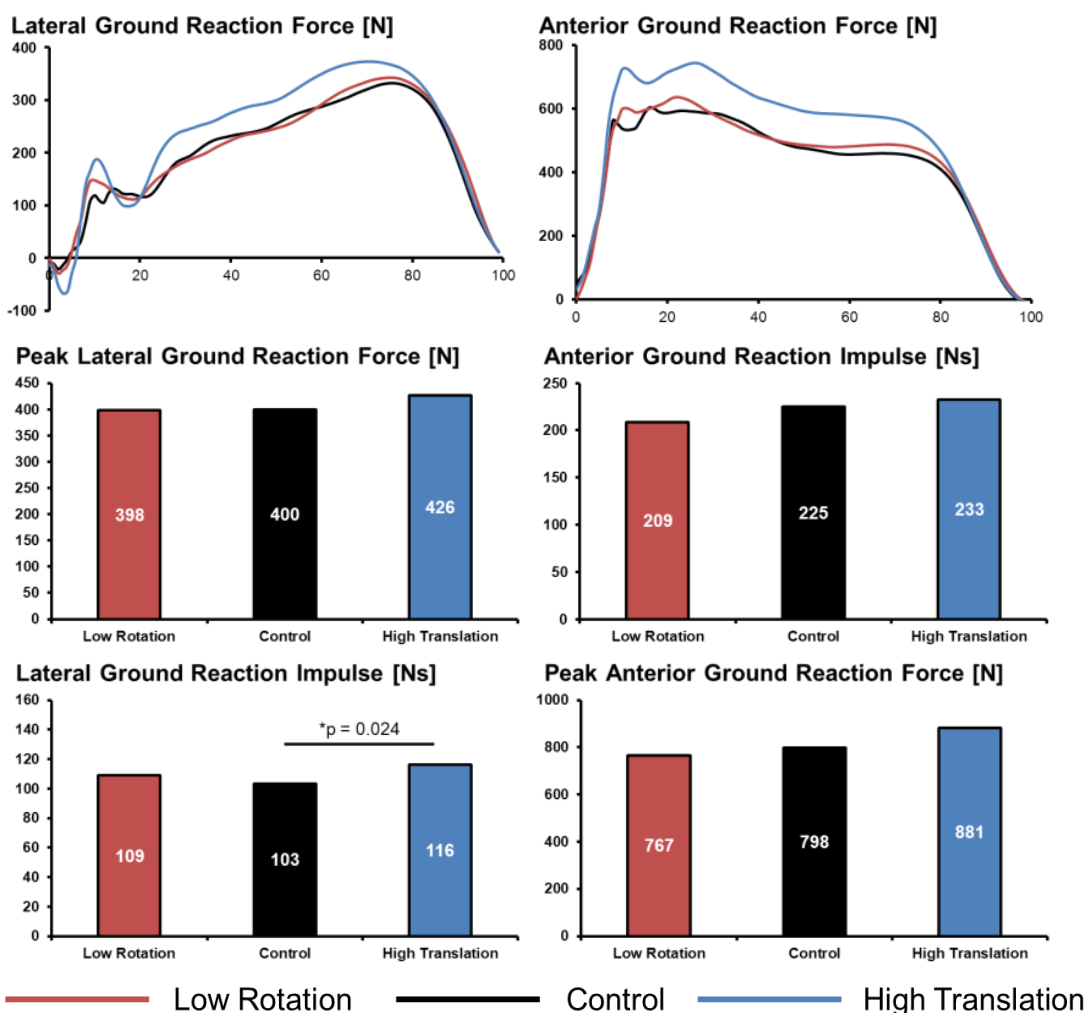

Figure 7-6. Horizontal ground reaction force traces (top row), peak horizontal ground reaction force (middle row) and horizontal ground reaction impulse (bottom row) during the stance phase of the s-cut for the three footwear conditions. Data represent the average values from all subjects, with data being normalized from touchdown to toe off.

Ankle joint moment curves, peak moment, and angular impulse values can be seen in Figure 7-7 for the v-cut and Figure 7-8 for the s-cut. In terms of ankle joint moments during the v-cut the low rotation shoe significantly reduced both the peak moment and

angular impulse in the transverse plane ($p < 0.001$ peak moment and $p = 0.003$ for the angular impulse). The high translation shoe had no effect on the ankle joint moments.

V-Cut

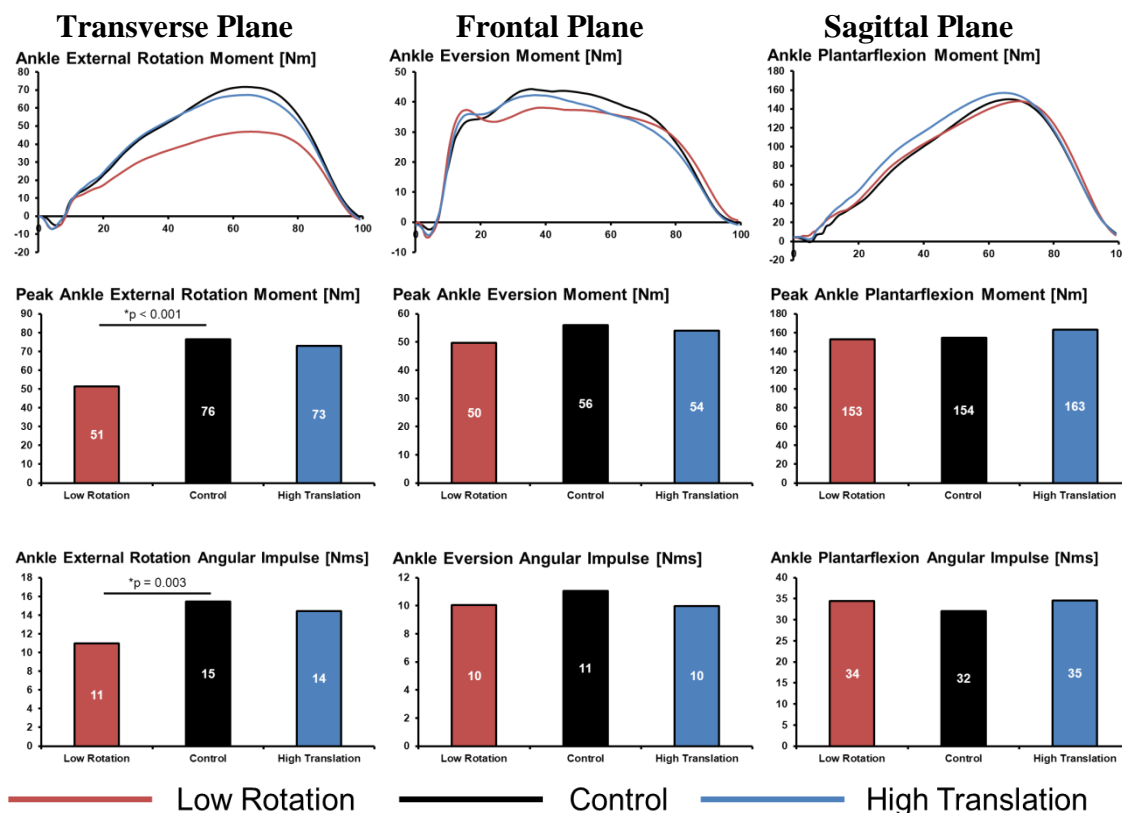

Figure 7-7. Ankle joint moment curves (top row), peak ankle joint moment values (middle row) and ankle joint angular impulse during the stance phase of the v-cut for the three footwear conditions. Data represent the average values from all subjects, with data being normalized from touchdown to toe off.

For the s-cut, the low rotation shoe significantly reduced the loading in the transverse plane ($p < 0.001$ both for peak moment and angular impulse). The high translation shoe did affect the joint moments, increasing the peak frontal plane moment ($p = 0.003$) as well

as the sagittal plane peak moments and impulse ($p=0.008$ for the peak moment and $p=0.038$ for the angular impulse).

S-Cut

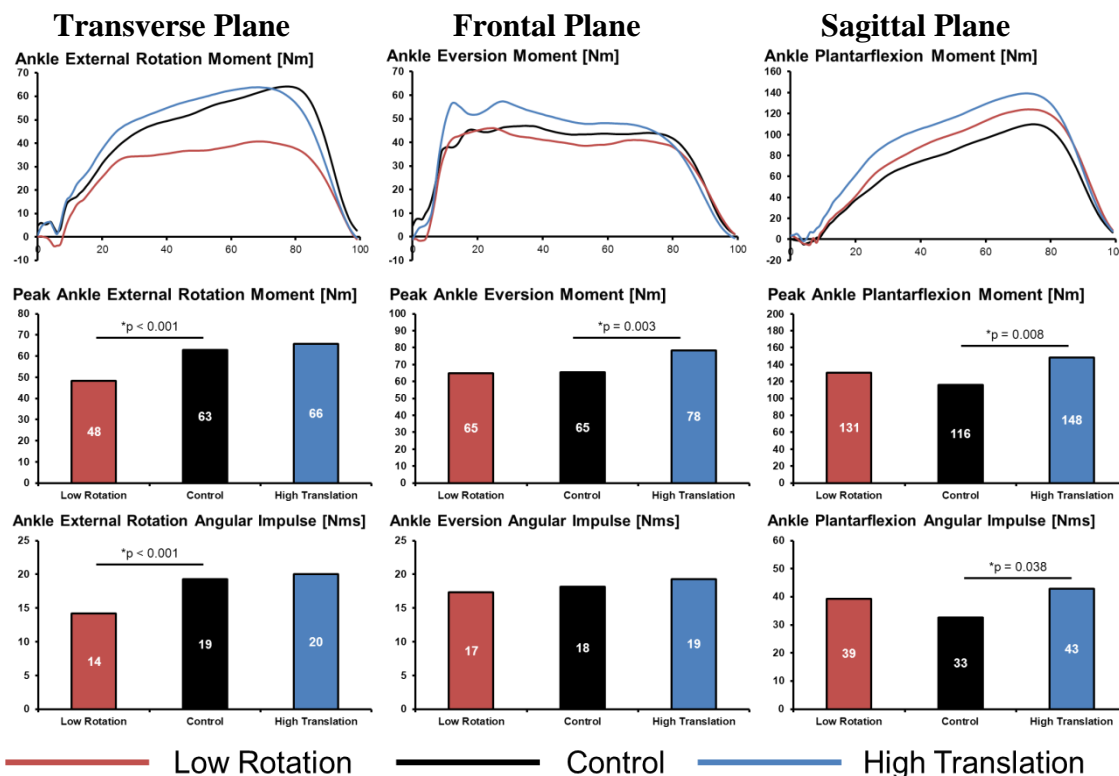

Figure 7-8. Ankle joint moment curves (top row), peak ankle joint moment values (middle row) and ankle joint angular impulse during the stance phase of the s-cut for the three footwear conditions. Data represent the average values from all subjects, with data being normalized from touchdown to toe off.

The knee joint moment traces, peak moment and angular impulse values can be seen in Figure 7-9 for the v-cut and Figure 7-10 for the s-cut. During the v-cut, the low rotation shoe had significant reductions in the transverse ($p=0.029$) and frontal ($p=0.01$) plane peak joint moments, in addition to significant increases in both sagittal plane peak joint

moments ($p=0.029$) and angular impulses ($p=0.019$). No differences were seen between the high translation shoe and the control during the v-cut

V-Cut

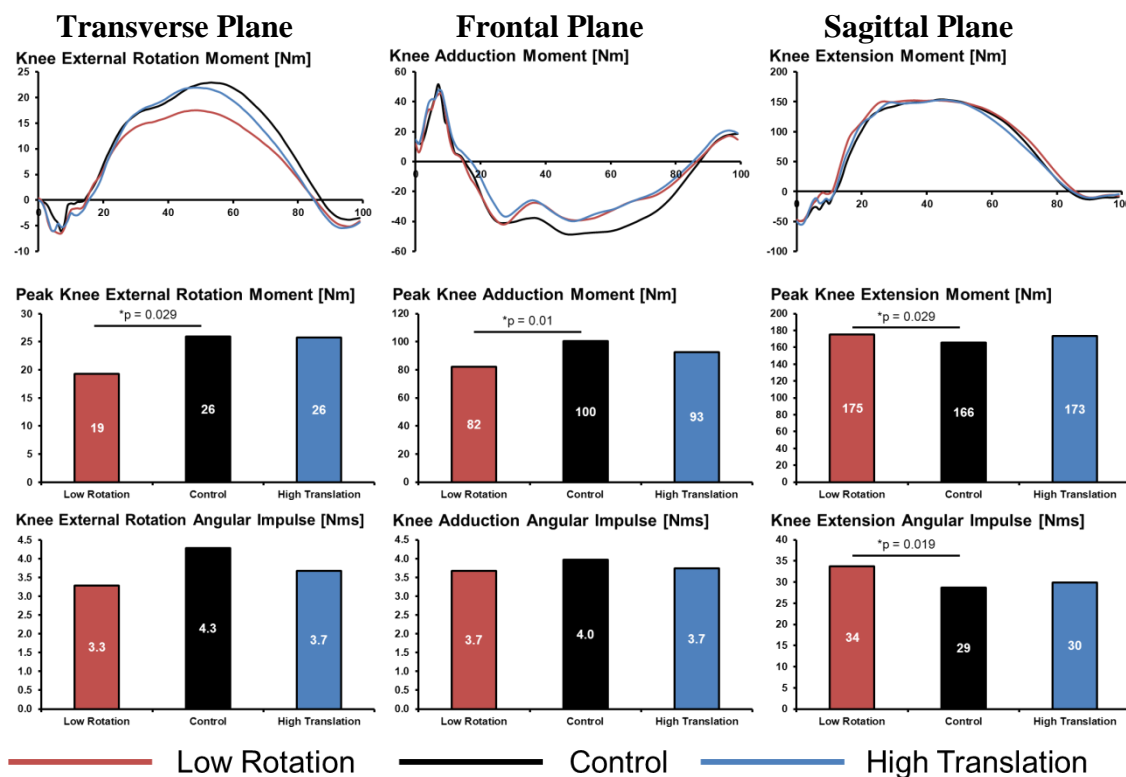

Figure 7-9. Knee joint moment curves (top row), peak knee joint moment values (middle row) and knee joint angular impulse during the stance phase of the v-cut for the three footwear conditions. Data represent the average values from all subjects, with data being normalized from touchdown to toe off.

During the s-cut, the low rotation shoe had significant reductions in the transverse plane peak joint moments ($p=0.008$) and angular impulses ($p<0.001$), while the high translation shoe had increases in frontal plane angular impulse ($p=0.045$).

S-Cut

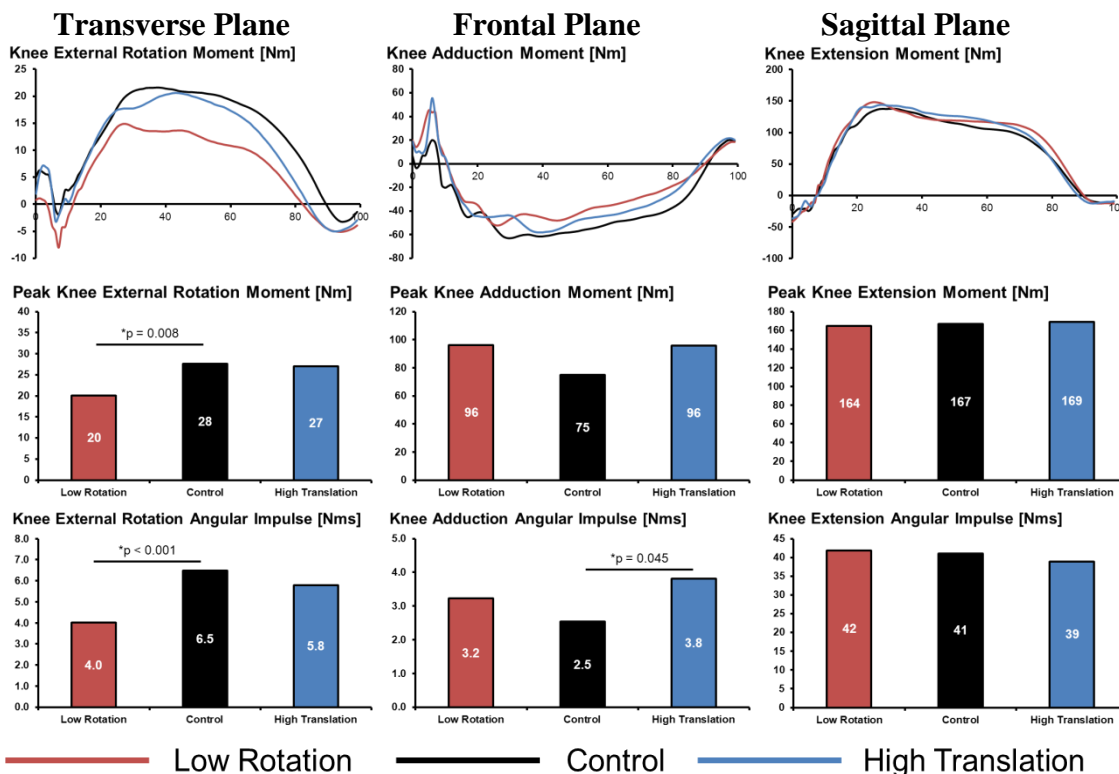

Figure 7-10. Knee joint moment curves (top row), peak knee joint moment values (middle row) and knee joint angular impulse during the stance phase of the s-cut for the three footwear conditions. Data represent the average values from all subjects, with data being normalized from touchdown to toe off.

7.4 Discussion

Since the early 1970's footwear traction has been linked to possible causes of lower extremity non-contact injury in sport (Torg et al. 1973; Torg et al. 1974). Subsequent studies have presented data providing evidence that rotational footwear traction is associated with lower extremity injury (Lambson et al. 1996). Based on that result, recent studies (Livesay et al. 2006; Villwock et al. 2009a) focussed on rotational traction alone, completely ignoring translational traction without justification. Additionally, these

studies did not attempt to determine why or how rotational traction may affect injuries, specifically the mechanism behind these increases in injury. The results from chapter 6 of this thesis indicate that not only rotational traction but also translational traction can have an effect on lower extremity non-contact injuries. Therefore, the purpose of this study was to determine how independent changes in translational and rotational traction can affect joint loading (represented by peak joint moments and angular impulse), in an attempt to reveal information on the injury mechanism.

This study revealed that the individual components of both rotational traction as well as translational traction can influence joint loading, indicating that both components are important when related to injury risk.

During the v-cut movement, increases in translational traction had no effect on the joint moments or angular impulse at the ankle or knee joint. Rotational traction, however, had a large influence on joint moments at the ankle and the knee. By reducing the rotational traction by approximately 40%, the peak transverse plane ankle and knee moments were reduced by 33% and 27% respectively, while the peak knee adduction moment was also reduced by 18%. These results were similar to the results of Wannop et al. (2010), which showed that increases in traction (both translational and rotational) lead to similar increases in the transverse and frontal plane loading of the ankle and knee joint. Since the footwear used in the previous study incorporated changes in both translational and rotational traction concurrently, it was unclear which component of traction was causing

the joint loading increases, however from the results of the current study, the differences can be attributed to the increases in the rotational traction of the footwear.

In terms of injury risk, joint moments are thought to be indicative of the loading that the joint is experiencing (Hurwitz et al. 1998). The peak joint moments would, therefore, be representative of the peak loading that the joint experiences during the athletic movement, which could potentially lead to various acute injuries of the joint structures. For the ankle joint, it has been shown that 90% of all ligamentous injuries are caused by internal rotation and inversion of the foot (Stacoff et al. 1996), therefore, these lower joint moments while wearing the low rotation shoe would keep the ankle joint farther away from injury. In the knee joint the ‘plant and cut’ movement has been proposed as the possible mechanism for ACL tear, due to a sudden deceleration and rapid twisting of the ligament (Baker 1990; Myklebust et al. 1997; Myklebust et al. 1998), so the reduction of the joint loading in the transverse and frontal plane by reducing the rotational traction of the footwear would be beneficial in terms of injury risk.

During the s-cut, similar results to the v-cut were seen in the transverse plane, with a reduction of the peak moments by 24% and 29% for the ankle and knee joint respectively in the low rotation shoe. Additionally, a reduction of 38% in the transverse plane angular impulse was seen at the knee. For this specific movement, translational traction also had an influence on the joint moments, with an increase of 50% in the ankle eversion moment as well as an increase of 52% for the knee adduction angular impulse. These results support the findings of Stefanyshyn et al. (2010), as they showed increases in rotational

traction leading to increases in joint loading, and the trend of increases in translational traction leading to increases in joint loading.

In terms of injury risk, the reduction of the joint moments at the ankle and knee in the transverse plane with the low rotation shoe would reduce the acute injury risk at these structures. Since the angular impulse represents the total loading that the joint experiences, increases in this variable have been linked to chronic types of injuries, with large frontal plane angular impulses being associated with injuries such as patellofemoral pain syndrome (Stefanyshyn et al. 2006) and osteoarthritis (Thorp et al. 2006). The fact that increases in translational traction also caused increases in the joint loading, relates to the fact that this component of traction also has an influence on injury and should not be ignored.

Examining the movements performed in this study in more detail, it is reasonable to assume that the different movements had different traction requirements. The v-cut was more of a pivot movement where the athlete planted their foot and pivoted in order to maintain a high movement speed, while the s-cut was more of start and stop type movement to facilitate the rapid change in direction (while still incorporating a pivoting movement of the foot on the ground). Rotational traction would be more important for pivoting on the surface, explaining why rotational traction affected the transverse plane loading for both movements, while translational traction did not. The translational traction was more important for the rapid change in direction of the s-cut, explaining the fact that translational traction had an influence on the frontal plane loading during this

movement. Football is a very dynamic sport, with many different movement patterns. These different movement patterns will all require individual amounts of both translational and rotational traction. The movements for the current study were selected because they were thought to be common in football, however, there are many other movements that are utilized in football that may also affect joint loading due to different required amounts of rotational and translational traction.

Relating back to the chapter 6 injury data, the results do help in the understanding of how traction can affect injury, but also raise some new questions. The injury results showed that increases in rotational traction were associated with increases in injury, which was supported by the joint loading results as increases in loading in the transverse and frontal plane were seen with increasing rotational traction. For translational traction the conclusions are less certain. Increases in translational traction does increase joint loading for certain movements which could lead to an increase in injury risk. The injury results of chapter 6 showed that after a certain value, further increases in translational traction were associated with a drop off in the injury rate. The results of the current study cannot explain the drop in injury rate with increasing translational traction, but the results do provide support to the fact that translational traction can influence joint loading and potentially joint injury.

While the footwear traction of each shoe was measured, it remains unclear exactly which traction 'group' each shoe condition belonged to relating to chapter 6. Since the method of testing was different between studies (due to the limited availability of the portable

traction tester used in chapter 6), it is difficult to relate the traction results directly. It has been shown that laboratory testing using a sample surface and testing on the actual surface can vary substantially (Severn et al. 2010), and even though the sample surface was constructed according to the manufacturer some differences between the sample and actual surface are likely present. The main differences would likely be from the lack of a shockpad underlying the sample surface, as well as the possible compaction of the in-fill material due to a lack of 'fluidity' of the surface. All of these factors have been shown to influence traction measurements (Severn et al. 2010; Severn et al. 2011).

It is believed that the rotational traction of the control and high translational shoe were on the higher end of the spectrum, due to the length of the studs coupled with the large proximity from the central rotation point. It was, however, thought that the translational traction of the high translation shoe was more in the mid-range simply due to the absence of many secondary traction elements that were common in the cleated footwear tested in chapter 6. It would be interesting to test more footwear conditions, that have multiple variations in the translational traction, with constant rotational traction to determine how this would affect joint loading. It would be interesting to see if further increases in translational traction would lead to decreases in the ankle and knee joint loading as the injury data from chapter 6 suggest.

There were several limitations present in the study that may have influenced both the results of the traction tests and the joint loading. First, the traction values presented are only representative for the loading conditions and the directions for which each shoe was

mechanically tested. The previous results of this thesis have shown that the loading conditions can affect traction measurements. As well, during the execution of the v-cut and s-cut, the foot was likely oriented and loaded in a different manner than during the mechanical traction tests. The mechanical traction values of the footwear in different orientations were unknown. The rotation point during traction testing was set as the center cleat, but it is unlikely that this was upheld during the execution of the movements by the athletes. The alteration of this rotation point could have changed the rotational traction of the footwear. Additionally, the footwear used in this experiment were custom made and some participants expressed that they were uncomfortable. Added to the fact that the low rotation shoe had much different orientation of cleats than most athletes were accustomed to, this may have changed the movement patterns of the athlete separate from the effect of the traction alone.

7.5 Conclusion

This study determined that both rotational as well as translational traction can affect both the ankle and knee joint loading during football related movements. From the results of this study, coupled with the results of the previous injury study it is believed that these increases in joint loading (joint moments and angular impulses) in the transverse and frontal plane are one of the possible mechanisms in terms of lower extremity non-contact injury.

Chapter Eight: Summary and Future Directions

Over the past forty years footwear traction has been cited as one of the causes of non-contact lower extremity injury in sport (Torg et al. 1973; Torg et al. 1974; Lambson et al. 1996; Meyers et al. 2004). While past research has determined that an association exists between rotational traction and ACL injury (Lambson et al. 1996), the exact relationship as well as the role of translational traction on all types of lower extremity, non-contact injury is unknown. In the past decade, new generations of artificial turf, as well as engineered grasses and soils, have been developed which will influence the footwear traction of athletes. However, no studies have been conducted along the lines of Lambson's study (1996) on these new surfaces. Lastly, prior research indicated that increases in traction may lead to injury, however, they did not attempt to explain the mechanism involved.

Therefore, the main purposes of this thesis were to:

- 1) Determine the range of traction that is present in Canadian high school football on artificial turf and natural grass surfaces.
- 2) Determine how characteristics of testing methods affect measured traction values. Specifically, how normal load, testing movement speed, surface moisture, and testing location affect both translational and rotational traction on artificial and natural turf.
- 3) Determine if a relationship exists between an athlete's specific footwear traction (translational and rotational) and the incidence of lower extremity non-contact injury.

- 4) Determine how independently altering the translational and rotational traction affects knee and ankle joint loading, in order to investigate the injury mechanism for non-contact sport related injuries.

8.1 Footwear Traction in High School Football

In past studies, a small sampling of footwear was used to represent the footwear worn by the total population (Torg et al. 1973; Torg et al. 1974; Lambson et al. 1996). This may have been sufficient due to the smaller number of shoe models worn at the time, however, currently there are many different companies that produce many different models of cleated footwear worn in football. Additionally, most previous studies collected traction data using sample shoes, on sample surfaces, in a laboratory setting (Stanitski et al. 1974; Torg et al. 1974; Torg et al. 1996; Lambson et al. 2006; Livesay et al. 2006; Villwock et al. 2009a). These laboratory tests may not be representative of what is occurring on the actual field of play using the players' real footwear. Therefore, one purpose of this dissertation was to determine the range of translational and rotational traction that exists in cleated footwear of athletes, on the actual surface of play of a natural grass field as well as an artificial turf field used for Canadian high school football.

The results indicated that the translational traction of the footwear is higher on natural grass, while the rotational traction is higher on artificial turf. It is important to note that large differences in traction were seen in identical shoe models that were in different conditions, in terms of wear. Shoes that were newer had greater traction (0.84 and 50Nm for translational and rotational traction) than the same model of a shoe which was worn

(0.72 and 22Nm for translational and rotational traction). Due to the wear seen in the cleats, collecting traction data using the athletes' footwear on the actual surface of play should result in a more accurate estimate of footwear traction.

From this study it was shown that there is a large variety of shoes and, therefore, traction present in high school football. Traction data collected with athletes' footwear on the actual surface of play may provide more accurate data due to the effect of wear on traction.

8.2 Footwear Traction Testing Conditions

There has been mixed results on how different boundary or testing conditions can affect footwear traction (Torg et al. 1974; Bonstingl et al. 1975; Heidt et al. 1996; Livesay et al. 2006; Kuhlman et al. 2010). Studies have displayed data showing that normal load, movement speed, surface moisture, as well as testing location can influence traction measurements, however, the exact relationships of these variables to traction are not known.

Three sample shoes that represented different types of cleats used in football had their translational and rotational traction measured on the playing surface of a natural grass and artificial turf field. The traction was measured with different normal loads, movement speeds, surface moisture conditions as well as on different areas of the field.

All variables had an influence on footwear traction. Normal load had a linear effect on both translational and rotational components of traction with the ranking of the footwear remaining constant (e.g. shoe one always had higher traction than shoe two when tested at all normal loads). This suggests that testing at low normal loads may be sufficient for traction testing. Movement speed also had a linear relationship for translational traction, with increases in movement speed leading to increases in translational traction, but was constant for rotational traction with the footwear rankings remaining constant (e.g. shoe one always had higher traction than shoe two when tested at all movement speeds). This suggests that slow speeds are sufficient for traction testing. Surface moisture had a large effect on footwear traction and was shoe and surface specific. The testing location on the playing surface had a large effect on traction, with the high traffic areas (center location) having less traction than the low traffic areas (sidelines). This result was seen irrespective of the surface (artificial turf and natural grass).

The results showed that the boundary conditions during traction testing are very important and will have a large influence on traction measurements. The normal load, movement speed as well as testing location should all be considered when collecting footwear traction data.

8.3 Traction and Lower Extremity Non-Contact Injury

The purpose of this part of the dissertation was to examine the relationship between footwear traction and lower extremity non-contact injury. Over the course of three years, 555 athletes had their footwear traction measured on the actual playing surface of both a

natural and artificial turf surface. Concurrently, the athletes were followed throughout the year and the data on their injuries were recorded by certified athletic therapists on site at their games.

The results of the study showed that there were no differences in non-contact injury rates between the two playing surfaces (natural or artificial turf). When the athletes were grouped based on their footwear traction, a relationship between rotational traction and incidence of non-contact lower extremity injury was seen, with increases in rotational traction leading to increases in the injury rate. A relationship between translational traction and non-contact lower extremity injury was also observed, with high translational traction leading to a reduction in the injury rate.

It is recommended that athletes consider selecting footwear with the lowest rotational traction values for which no detriment in performance results. Additionally, in order to reduce non-contact lower extremity injury rates, footwear with a translational traction coefficient in the mid-range should be avoided.

8.4 Footwear Traction and Lower Extremity Joint Loading

Following the result that not only rotational traction, but also translational traction was associated with non-contact lower extremity injury, the influence of both components individually on joint loading was investigated. Previous research has shown that joint moments calculated by inverse dynamics can give an indication of the loading that the joint experiences (Hurwitz et al. 1998; Thorp et al 2006). Therefore, the purpose of this

aspect of the dissertation was to investigate how each component of traction independently affects lower extremity joint moments in order to gain insight into the injury mechanism regarding lower extremity non-contact footwear traction related injuries.

Three shoe conditions were constructed which had independent alterations in translational and rotational traction: a control condition, a low rotational traction condition (with similar translational traction to the control) and a high translational traction condition (with similar rotational traction to the control). Kinematic and kinetic data were collected while athletes performed two cutting maneuvers (v-cut and s-cut) in each of the three conditions on an artificial turf surface, in a laboratory setting.

The results indicated that both rotational traction as well as translational traction can affect the ankle and knee joint loading during football related movements. Increases in rotational traction led to increases in transverse and frontal plane loading, while increases in the translational traction led to increases in frontal plane loading at the ankle and knee. From the results of this study, coupled with the results of the previous injury study it is believed that these increases in joint loading (joint moments and angular impulses) in the transverse and frontal plane are one of the possible mechanisms of lower extremity non-contact injury.

8.5 Future Directions

While it is common practice to measure translational traction in the anterior/posterior directions, the traction of the footwear in other directions may also be of importance in terms of foot-fixation and traction related injury. When performing cutting maneuvers and rapid changes in direction the athlete may place their foot in different orientations requiring higher traction in the medial/lateral direction. This medial/lateral component may be an important aspect in terms of non-contact injury but it has never been investigated in great detail. The initial step may be to investigate if there is a relationship between footwear traction measured in the anterior/posterior direction and traction measured in the medial/lateral direction. Footwear that has high traction in the anterior/posterior direction could potentially possess high traction in the medial/lateral direction as well. However, there may be no correlation between traction in the two directions, with some footwear being affected by movement direction to a greater degree than others, due to the directionality of individual traction elements. Once this first investigation is complete, the results may warrant further probing into how footwear traction in different directions may be associated with foot fixation, joint moments and non-contact, lower extremity injury.

While researchers have associated rotational traction with injury for many years, the results of this thesis were the first to indicate that translational traction may also have an impact in terms of non-contact footwear related injuries. It is clear that increases in rotational traction are associated with an increase in the injury rate, with the mechanism thought to be due to the increased joint moments at the knee and ankle. What is not clear,

however, is the influence that translational traction may have on both injury and joint moments. The results of the thesis indicated that the mid values of translational traction are associated with the greatest injury risk, but there is still the question as to why that is. Future studies need to be focussed on this relationship between translational traction and both joint moments and injury. Future studies should start by investigating how alterations in translational traction alone (with no change in rotational traction), influence joint moments. Perhaps implementing footwear with greater translational traction than what was measured in Chapter 7 will be matched with a decrease in resultant joint moments, potentially explaining the injury results of chapter 6. Perhaps athletes are altering their movement techniques and patterns, reducing their movement intensity in these high traction shoes due to either a conscious or unconscious knowledge of an increased risk of injury. Future work should focus on these intricacies of the influence of translational traction on injury.

Many studies have been quick to point out that high rotational traction may be detrimental in terms of injury, and the results of this thesis support that statement. While decreases in rotational traction seem to provide a decrease in injury risk, no studies have examined the effect that reducing rotational traction may have on performance. Recent studies have determined the influence that translational traction may have on performance, but much like the link between translational traction and injury, rotational traction and performance seems to have been somewhat ignored. Future work should focus on determining how reducing rotational traction influences performance and

perhaps determining a threshold whereby rotational traction is low enough to reduce injury risk, yet still high enough to not cause any detriment in performance.

8.6 Conclusions

The results of this thesis provided important findings regarding the relationship between footwear traction and lower extremity non-contact injury. The loading conditions and location of traction testing of a playing surface have a large influence on footwear traction measurements. Studies investigating traction using sample shoes and surfaces may be limited due to the large range of traction used by athletes, as well as the effect that wear can have on traction. Increases in rates of lower extremity non-contact injuries of high school football players were observed with increases in rotational traction. As well, translational traction seemed to have an influence on injury, as the mid-range of traction values (0.686-0.719) had an increased injury rate compared to the high range of traction values (0.720-0.970). The mechanism behind increased injury rates due to rotational traction is thought to be due to the increase in joint loading in the frontal and transverse plane that occurs with increased rotational traction. The mechanism behind decreased injury rates due to increases in translational traction is not clear and requires additional study.

Several limitations were present in the current thesis that may have influenced the results. When performing mechanical traction measurements, it is important to remember that the results are sensitive to the boundary conditions during testing. While some of these variables were easy to control (normal load, movement speed), others were out of the

control of the investigator (surface temperature, ground hardness, surface moisture). While every effort was made to keep these conditions similar between testing sessions, fluctuations in the surface temperature, ground hardness and surface moisture were present and could have influenced the traction measurements.

The traction data for chapter six are only representative for the mechanical testing methods employed. The traction was tested in the forward direction (translational traction) and the internal rotation direction (rotational traction) with the forefoot only. This may have not been representative of what was occurring when the athlete was injured, and, therefore, the traction values may have been different. Additionally, wearing down of the surface did occur as the season progressed, which would have affected the traction values of the footwear. Perhaps implementing multiple footwear testing sessions at the beginning, middle and end of the season or performing additional traction tests in other directions may remove this limitation, but for the current study that was not feasible.

While every effort was made to get accurate injury data, some sources of bias may have been present. The athletic therapists usually filled out the injury data forms directly after an injury occurred, however this was not always the case. In some cases, the athlete would not report their injury right away or there may have been multiple injuries at the same time that delayed reporting and recording of injury data. Additionally, the injury data were based off of the athletes' recall of the mechanism of the injury, which leaves some possibility of potential recall bias. Since completion of the study, video recorders

have been implemented at the fields which may allow for the elimination of this recall bias. Lastly, non-contact lower extremity injuries are very complex, and are likely affected by multiple variables. It must be recognized that footwear traction is not the only variable that can have an influence on the injury rate.

While this study added valuable information regarding footwear traction and non-contact lower extremity injury, some new questions have arisen. Mainly, the result that increasing translational traction resulted in increases in joint loading, which did not explain the decrease in injury rate with high translational traction.

References

- Adkison, J. & Requa, R., 1974. Injury rates in high school football: a comparison of synthetic surfaces and grass fields. *Clinical Orthopaedics and Related Research*, p.131-136.
- Alles, W., Powell, J. & Buckley, W., 1979. The national athletic injury/illness reporting system 3-year findings of high school and college football injuries. *Journal of Orthopaedic & Sports Physical Therapy*, 1(2), p.103-108.
- Andreasson, G., Lindenberger, U., Renstrom, P. & Peterson, L., 1986. Torque developed at simulated sliding between sport shoes and an artificial turf. *The American Journal of Sports Medicine*, 14(3), p.225-230.
- Andresen, B., Hoffman, M. & Barton, L., 1989. High school football injuries: field conditions and other factors. *Wisconsin Medical Journal*, 88, p.28-31.
- Arendt, E. & Dick, R., 1995. Knee injury patterns among men and women in collegiate basketball and soccer. NCAA data and review of literature. *The American Journal of Sports Medicine*, 23(6), p.694-701.
- Ateshian, A. & Mow, V., 2005. Friction, lubrication, and wear of articular cartilage and diarthrodial joints. In V. Mow & R. Huijskes, eds. *Basic orthopaedic biomechanics & mechano-biology*. Philadelphia PA: Lippincott Williams & Wilkins, p.447-494.
- Bahr, R., Kannus, P. & van Mechelen, W., 2003. Epidemiology and prevention of sports injuries. In: Kjaer M, Krogsgaard M, Magnussen SP, eds. *Textbook of sports medicine. Basic science and clinical aspects of sports injury and physical activity*. Oxford: Blackwell Science, p. 299-314.
- Baker, B., 1990. Prevention of ligament injuries to the knee. *Exercise and Sport Sciences Reviews*, 18, p.291-305.
- Besier, T., Lloyd, D., Cochrane, J. & Ackland, T., 2001. External loading of the knee joint during running and cutting, maneuvers. *Medicine & Science in Sports & Exercise*, 33 p.1168-1175.
- Bhushan, B., 1999. *Principles and Applications of Tribology*, Wiley, New York.
- Bhushan, B., 2002. *Introduction to Tribology*. Wiley, New York.
- Bonstingl, R., Morehouse, C. & Niebel, B., 1975. Torques developed by different types of shoes on various playing surfaces. *Medicine & Science in Sports & Exercise*, 7(2), p.127-31.

- Bowers, K. & Martin, R., 1975. Cleat-surface friction on new and old Astroturf. *Medicine & Science in Sports & Exercise*, 7(2), p.132-135.
- Bramwell, S., Requa, R. & Garrick, J., 1972. High school football injuries: a pilot comparison of playing surfaces. *Medicine & Science in Sports & Exercise*, 4(3), p.166-169.
- Braun, B., 1999. Effects of ankle sprain in a general clinic population 6 to 18 months after medical evaluation. *Archives of Family Medicine*, 8(2), p.143-8.
- Burt, C. & Overpeck, M., 2001. Emergency visits for sports related injuries. *Analysis of Emergency Medicine*, 37(3), p.301-308.
- Cameron, B. & Davis, O., 1973. The swivel football shoe: A controlled study. *The American Journal of Sports Medicine*, 1(16). p.16-27.
- Cohen, J. 1992. Quantitative methods in psychology: A power primer. *Psychological Bulletin*, 112(1). P.155-159.
- Culpepper, M. & Niemann, K., 1983. High school football injuries in Birmingham Alabama. *Southern Medical Journal*, 76(7), p.873-878.
- Dvorak, J., Junge, A., Chomaik, J., Graf-Baumann, T., Peterson, L., Rosch, D. & Hodgson, R., 2000. Risk factor analysis for injuries in football players: Possibilities for a prevention program. *Sports Medicine*, 28(5), p.S69-S74.
- Ekstrand, J. & Nigg, B., 1989. Surface related injuries in soccer. *Sports Medicine*, 8, p.56-62.
- Ekstrand, J., Timpka, T. & Häggglund, M., 2006. Risk of injury in elite football played on artificial turf versus natural grass: a prospective two-cohort study. *British Journal of Sports Medicine*, 40(12), p.975-80.
- Emery, C., Meeuwisse, W. & Hartmann, S., 2005. Evaluation of risk factors for injury in adolescent soccer. *The American Journal of Sports Medicine*, 33, p.1882-1891.
- Emery, C., Meeuwisse, W. & Mcallister, J., 2006. Survey of sport participation and sport injury in Calgary and area high schools. *Clinical Journal of Sport Medicine*, 16(1), p.20-26.
- Fong, D., Hong, Y., Chan, L., Yung, P. & Chan, K., 2007. A systematic review on ankle injury and ankle sprain in sports. *Sports Medicine*, 37(1), p.73-94.
- Frederick, E., 1986. Kinematically mediated effects of sport shoe design: a review. *Journal of Sports Sciences*, 4, p.169-184.

- Fuller, C., Dick, R., Corlette, J. & Schmalz, R., 2007. Comparison of the incidence, nature and cause of injuries sustained on grass and new generation artificial turf by male and female football players. Part 1: match injuries. *British Journal of Sports Medicine*, 41(S1), p.i20-6.
- Gallagher, S., Finison, K., Guyer, B. & Goddenough, S., 1984. The incidence of injuries among 87,000 Massachusetts children and adolescents: results of the 1980-81 statewide childhood injury prevention program surveillance system. *American Journal of Public Health*, 74(12), p.1340-7.
- Garrick, J. & Requa, R., 1988. The epidemiology of foot and ankle injuries in sports. *Clinics in Sports Medicine*, 7(1), p.29-36.
- Gunnoe, A., Horodyski, M. & Tennant, L., 2001. Injury in high school football players. *Journal of Athletic Training*, 36(2), p.150-155.
- Gómez, J., Ross, S., Calmbach, W., Kimmel, R., Schmidt, D. & Dhanda, R., 1998. Body fatness and increased injury rates in high school football linemen. *Clinical Journal of Sport Medicine*, 8(2), p.115-120.
- Hanley, D., 1969. Controllable external factors in lower extremity injuries. In Medical Society of the State of New York Symposium on Medical Aspects of Sports.
- Heidt, R., Dormer, S., Cawley, P., Scranton, P., Losse, G. & Howard, M., 1996. Differences in friction and torsional resistance in athletic shoe-turf surface interfaces. *The American Journal of Sports Medicine*, 24(6), p.834-842.
- Hewett, T., Myer, G., Ford, K., Heidt, R., Colosimo, A. & McLean, S., 2005. Biomechanical measures of neuromuscular control and valgus loading of the knee predict anterior cruciate ligament injury risk in female athletes: a prospective study. *The American Journal of Sports Medicine*, 33(4), p.492-501.
- Hoffman, M. & Lyman, K., 1988. Medical needs at high school football games. *Journal of Orthopaedic & Sports Physical Therapy*, 10, p.167-171.
- Hootman, J., Dick, R. & Agel, J., 2007. Epidemiology of collegiate injuries for 15 sports : prevention initiatives. *Journal of Athletic Training*, 42(2), p.311-319.
- Hosea, T., Carey, C. & Harrer, M., 2000. The gender issue: epidemiology of ankle injury in athletes who participate in basketball. *Clinical Orthopaedic Related Research*, 372, p.45-49.

- Hurwitz, D., Sumner, D., Andriacchi, T. & Sugar, D., 1998. Dynamic knee loads during gait predict proximal tibial bone distribution. *Journal of Biomechanics*, 31(5), p.423-30.
- James, I. & McLeod, A., 2010. The effect of maintenance on the performance of sand-filled synthetic turf surfaces. *Sports Technology*, 3(1), p.43-51.
- Kaila, R., 2007. Influence of modern studded and bladed soccer boots and sidestep cutting on knee loading during match play conditions. *The American Journal of Sports Medicine*, 35(9). p.1528-1536.
- Keene, J. & Narechania, R., 1980. Tartan turf on trial. *The American Journal of Sports Medicine*, (3), p.43-47.
- King, M., Pickett, W. & King, M., 1998. Injury in Canadian youth: a secondary analysis of the 1993-94 health behaviour in school-aged children survey. *Canadian Journal of Public Health*, 89(6), p.397-401.
- Kirk, B., Carre, M., Haake, S. & Manson, G., 2006. Modelling traction of studded footwear on sports surfaces using neural networks. *The Engineering of Sport* 6, 10, p. 403-408.
- Kuhlman, S., Sabick, M., Pfeiffer, R., Cooper, B. & Forhan, J., 2010. Effect of loading condition on the traction coefficient between shoes and artificial turf surfaces. *Proceedings of the Institution of Mechanical Engineers, Part P: Journal of Sports Engineering and Technology*, 224(2), p.155-165.
- Lambson, R., Barnhill, B. & Higgins, R., 1996. Football cleat design and its effect on anterior cruciate ligament injuries: a three year prospective study. *The American Journal of Sports Medicine*, 24(2), p.155-159.
- Livesay, G., Reda, D. & Nauman, E., 2006. Peak torque and rotational stiffness developed at the shoe-surface interface: the effect of shoe and playing surface. *The American Journal of Sports Medicine*, 34, p.415-422.
- Luethi, S. & Nigg, B., 1985. The influence of different shoe constructions on discomfort and pain in tennis. In *Biomechanics IX-B*, p.149-53.
- Mallette, T., 1996. Frictional and tractional characteristics of various shoe-surface interface combinations on wet and dry natural and artificial turf. Michigan State University. Master's Thesis.
- McLain, L. & Reynolds, R., 1989. Sports injuries in a high school. *Pediatrics*, 84(3), p.446-450.

- Meyers, M. & Barnhill, B., 2004. Incidence, causes, and severity of high school football injuries on FieldTurf versus natural grass: A 5-year prospective study. *The American Journal of Sports Medicine*, 32, p.1626-1638.
- Meyers, M., 2010. Incidence, Mechanisms, and severity of game-related college football injuries on FieldTurf versus natural grass. *The American Journal of Sports Medicine*, 38, p.687-697.
- Muller, C., Sterzing, T., Lange, J. & Milani, T., 2010. Comprehensive evaluation of player-surface interaction on artificial soccer turf. *Sports Biomechanics*, 9(3), p.193-205.
- Myklebust, G. & Bahr, R., 2005. Return to play guidelines after anterior cruciate ligament surgery. *British Journal of Sports Medicine*, 39(3), p.127-131.
- Myklebust, G., Maehlum, S., Engebretsen, L., Strand, T. & Solheim, E., 1997. Registration of cruciate ligament injuries in Norwegian top level team handball. A prospective study covering two seasons. *Scandinavian Journal of Medicine & Science in Sports*, 7(5), p.289-292.
- Myklebust, G., Maehlum, S., Holm, I. & Bahr, R., 1998. A prospective cohort study of anterior cruciate ligament injuries in elite Norwegian team handball. *Scandinavian Journal of Medicine & Science in Sports*, 8(3), p.149-153.
- National Federation of State High School Associations, 2009. 2009-10 High School Athletics Participation Survey. Available at: <http://www.nfhs.com>.
- Nedwidek, R., 1969. Knee and ankle injuries: articulating opinion with research. *Scholastic Coaching*, 38(4).
- Nelson, A., Collins, C., Yard, E., Fields, S. & Comstock, R., 2007. Ankle injuries among United States high school sports athletes, 2005-2006. *Journal of Athletic Training*, 42(3), p.381-387.
- Nigg, B., 1986. Experimental techniques used in running shoe research. In BM Nigg, ed. *Biomechanics of Running Shoes*. Champaign, IL: Human Kinetics Publishers, pp. 27-61.
- Nigg, B. & Yeadon, M., 1987. Biomechanical aspects of playing surfaces. *Journal of Sports Sciences*, 5(2), p.117-145.
- Nigg, B., 1990. The validity and relevance of tests used for the assessment of sports surfaces. *Medicine & Science in Sports & Exercise*, 22(1), p.131-139.

- Nigg, B. & Anton, M., 1995. Energy aspects for elastic and viscous shoe soles and playing surfaces. *Medicine & Science in Sports & Exercise*, 27(1), p.92-97.
- Nigg, B., 2003. The stages of the Cirque du Soleil. In BM Nigg, G. Cole, & DJ Stefanyshyn, eds. *Sport Surfaces*. Calgary: University of Calgary, pp. 9-10.
- Nigg, B., Stefanyshyn, D., Rozitis, A. & Mundermann, A., 2009. Resultant knee joint moments for lateral movement tasks on sliding and non-sliding sport surfaces. *Journal of Sports Sciences*, 27(5), p.427-35.
- Orchard, J., 2002. Is there a relationship between ground and climatic conditions and injuries in football? *Sports Medicine*, 32(7), p.419-432..
- Pasanen, K., Parkkari, J., Rossi, L. & Kannus, P., 2008. Artificial playing surface increases the injury risk in pivoting indoor sports: a prospective one-season follow-up study in Finnish female floorball. *British Journal of Sports Medicine*, 42(June), p.194-197.
- Powell, J. & Schootman, M., 1992. A multivariate risk analysis of selected playing surfaces in the National Football League: 1980 to 1989. *The American Journal of Sports Medicine*, 20(6), p.686-684.
- Powell, J. & Barber-Foss, K., 1999. Injury patterns in selected high school sports: a review of the 1995-1997 seasons. *Journal of Athletic Training*, 34(3), p.277-284.
- Prager, B., Fitton, W., Cahill, B. & Olson, G., 1989. High school football injuries: a prospective study and pitfalls of data collection. *The American Journal of Sports Medicine*, 17(5), p.681-5.
- Ramirez, M., Schaffer, K., Shen, H., Kashani, S. & Kraus, J., 2006. Injuries to high school football athletes in California. *The American Journal of Sports Medicine*, 34(7), p.1147-58.
- Schlaepfer, F., Unold, E. & Nigg, B, 1983. The frictional characteristics of tennis shoes. In *Proceedings of The International Symposium on Biomechanical Aspects of Sport Shoes and Playing Surfaces*. pp. 153-160.
- Severn, K., Fleming, P. & Dixon, N., 2010. Science of synthetic turf surfaces : player – surface interactions. *Sports Technology*, 3(1), p.13-25.
- Severn, K., Fleming, P., Clarke, J. & Carre, M., 2011. Science of synthetic turf surfaces: investigating traction behaviour. *Proceedings of the Institution of Mechanical Engineers, Part P: Journal of Sports Engineering and Technology*, 225(3), p.147-158.

- Shankar, P., Fields, S., Collins, C., Dick, R. & Comstock, R., 2007. Epidemiology of high school and collegiate football injuries in the United States, 2005-2006. *The American Journal of Sports Medicine*, 35(8), p.1295-303.
- Sharma, L., Hurwitz, D., Thonar, E., Sum, J., Lenz, M., Dunlop, D., 1998. Knee adduction moment, serum hyaluronan level, and disease severity in medial tibiofemoral osteoarthritis. *Arthritis & Rheumatism*, 41(7), p.1233-40.
- Shin, C., Chaudhari, A. & Andriacchi, T., 2009. The effect of isolated valgus moments on ACL strain during single-leg landing: a simulation study. *Journal of Biomechanics*, 42(3), p.280-5.
- Skovron, M., Levy, I. & Agel, J., 1990. Living with artificial grass: A knowledge update: Part 2: Epidemiology. *The American Journal of Sports Medicine*, 18(5), p.510-513.
- Stacoff, A., Steger, J., Stussi, E. & Reinschmidt, C., 1996. Lateral stability in sideward cutting movements. *Medicine & Science in Sports & Exercise*, 28(3), p.350.
- Stanitski, C., McMaster, J. & Ferguson, R., 1974. Synthetic turf and grass: a comparative study. *The American Journal of Sports Medicine*, 2(1), p.22-26.
- Stefanyshyn, D., Stergiou, P., Lun, V., Meeuwisse, W. & Worobets, J. 2006. Knee angular impulse as a predictor of patellofemoral pain in runners. *The American Journal of Sports Medicine*, 34, p.1844-1851.
- Stefanyshyn, D., Lee, J. & Park, S., 2010. The influence of soccer cleat design on resultant joint moments. *Footwear Science*, 2(1), p.13-19.
- Steffen, K., Andersen, T. & Bahr, R., 2007. Risk of injury on artificial turf and natural grass in young female football players. *British Journal of Sports Medicine*, 41, p.i33-i37.
- Stevenson, M. & Anderson, B., 1981. The effects of playing surfaces on injuries in college intramural touch football. *Journal of National Intramural Recreational Sports Association*, 5, p.59-64.
- Struijs, P. & Kerkhoffs, G., 2002. Ankle sprain. *Clinical Evidence*, 7, p.945-953.
- Thorp, L., Wimmer, M., Block, J., Moisiu, K., Shott, S., Goker, B. & Sumner, D., 2006. Bone mineral density in the proximal tibia varies as a function of static alignment and knee adduction angular momentum in individuals with medial knee osteoarthritis. *Bone*, 39(5), p.1116-1122.

- Torg, J. & Quedenfeld, T., 1971. Effect of shoe type and cleat length on incidence and severity of knee injuries among high school football players. *Research Quarterly*, 42, p.203-211.
- Torg, J. & Quedenfeld, T., 1973. Knee and ankle injuries traced to shoes and cleats. *Physician and Sports Medicine*, 1, p.39-43.
- Torg, J., Quedenfeld, T. & Landau, S., 1974. The shoe-surface interface and its relationship to football knee injuries. *The American Journal of Sports Medicine*, 2(5), p.261-269.
- Torg, J., Stilwell, G. & Rogers, K., 1996. The effect of ambient temperature on the shoe-surface interface release coefficient. *The American Journal of Sports Medicine*, 24(1), p.79-82.
- Turbeville, S., Cowen, L., Owen, W., Asal, N. & Anderson, M. 2003. Risk factors for injury in high school football players. *The American Journal of Sports Medicine*, 31(6), p.974-980.
- Valiant, G., 1993. Friction-slipping-traction. *Sportverletzung Sportschaden*, 7, p. 171-178.
- Valderrabano, V., Hirsberger, M., Russell, I., Dougall, H. & Hintermann, B., 2009. Etiology of ankle osteoarthritis. *Clinical Orthopaedics and Related Research*, 467(7), p.1800-6.
- van Gheluwe, B., Deporte, E. & Hebbelinck, M., 1983. Frictional forces and torques of soccer shoes on artificial turf. in *Proceedings of the International Symposium on Biomechanical Aspects of Sport Shoes and Playing Surfaces*. pp. 161-168.
- Villwock, M., Meyer, E., Powell, J., Fouty, A. & Haut, R., 2009a. The effects of various infills, fibre structures, and shoe designs on generating rotational traction on an artificial surface. *Proceedings of the Institution of Mechanical Engineers, Part P: Journal of Sports Engineering and Technology*, 223(1), p.11-19.
- Villwock, M., Meyer, E., Powell, J., Fouty, A. & Haut, R., 2009b. Football playing surface and shoe design affect rotational traction. *The American Journal of Sports Medicine*, 37(3), p.518-25.
- Wannop, J., Luo, G. & Stefanyshyn, D., 2009. Wear influences footwear traction properties in Canadian high school football. *Footwear Science*, 1(3), p.121-127.
- Wannop, J., Worobets, J. & Stefanyshyn, D., 2010. Footwear traction and lower extremity joint loading. *The American journal of sports medicine*, 38(6), p.1221-8.

Warren, A., 1996. The friction and traction characteristics of various shoe-surface combinations with different vertical loads. Master's Thesis, Michigan State University.

Yeung, M., Chan, K., So, C. & Yuan, W., 1994. An epidemiological survey on ankle sprain. *British Journal of Sports Medicine*, 28(2), p.112-6.

Appendix A : Preseason Baseline Questionnaire



Study Subject ID#

(to be completed by study coordinator)

High School Football Study 2009

Preseason Baseline Questionnaire



Name: _____		Today's Date: _____	
Gender: <input type="checkbox"/> Male <input type="checkbox"/> Female		Day Month Year	
Age: _____		Phone #: () -	
Height: _____ feet _____ inches <i>or</i> _____ cms		Date of Birth: _____	
Weight: _____ (lbs)		Day Month Year	
Dominant Hand (for writing): <input type="checkbox"/> Right <input type="checkbox"/> Left			
Position: <input type="checkbox"/> RB <input type="checkbox"/> QB <input type="checkbox"/> DB/Safety <input type="checkbox"/> WR			Team: _____
<input type="checkbox"/> O-Line <input type="checkbox"/> D-Line <input type="checkbox"/> Linebacker			
Please check off how many years of organized football you have played prior to this season (check only one):			
<input type="checkbox"/> 0 years		<input type="checkbox"/> 4 years	<input type="checkbox"/> 8 years
<input type="checkbox"/> 1 year		<input type="checkbox"/> 5 years	<input type="checkbox"/> 9 years
<input type="checkbox"/> 2 years		<input type="checkbox"/> 6 years	<input type="checkbox"/> 10 years
<input type="checkbox"/> 3 years		<input type="checkbox"/> 7 years	<input type="checkbox"/> other
EQUIPMENT (check all that apply):			
a) mouthguard:			
at games: <input type="checkbox"/> always		at practises: <input type="checkbox"/> always	
<input type="checkbox"/> less than 75%		<input type="checkbox"/> less than 75%	
<input type="checkbox"/> never		<input type="checkbox"/> never	
type of mouthguard worn: <input type="checkbox"/> Dentist custom-fit <input type="checkbox"/> off the shelf			
b) Brace: <input type="checkbox"/> Knee <input type="checkbox"/> Ankle <input type="checkbox"/> Other*		c) Tape: <input type="checkbox"/> Knee <input type="checkbox"/> Ankle	
*specify: _____		*specify: _____	
MEDICAL/INJURY HISTORY:			
1. Have you ever had a serious lower extremity (knee, ankle, leg, foot) injury ?			
<input type="checkbox"/> Yes <input type="checkbox"/> No <i>if yes, please list:</i>			
Date:	Activity at the time	Time unconscious	Memory loss (yes or no)
(DD/MM/YY)	football skateboarding, etc.	0min 30sec	no
			Time loss before FULL return to sport
			1 day, 10 days, etc
b) If you answered yes to Question 1, please indicate whether you have any persistent problems:			

questionnaire continues (over) →

Preseason Baseline Questionnaire Page 2

High School Football Study 2009

2. In the past **6 weeks** have you had an injury requiring medical attention and at least one day of time lost from physical activity? Yes No

If **yes**, please describe this injury or these injuries to the best of your ability:

Injury Date	Injury Type	Body Part	Sport of Occurrence	Treatment description	Estimated time loss from sport (days/wks)
<i>(DD/MM/YY)</i>	<i>sprain, bruise, etc.</i>	<i>knee, nose, etc.</i>	<i>soccer, wakeboarding, etc.</i>	<i>first aid, physio, etc.</i>	<i>1 day, 3 weeks, etc</i>

3. In the past **one year**, have you had any other injury requiring medical attention & at least one day of time lost from physical activity? Yes No

If **yes**, please describe this injury or these injuries to the best of your ability:

Injury Date	Injury Type	Body Part	Sport of Occurrence	Treatment description	Estimated time loss from sport (days/wks)

4. Do you have any incompletely healed injury? Yes No

If **yes**, describe this injury to the best of your ability:

5. Have you been diagnosed by a physician with a bone fracture, arthritis, systemic disease (ie. cancer, heart disease), neurological disorder (ie. head injury, cerebral palsy) or have you required surgery in the past year?

Yes No

If **yes**, describe this condition(s) to the best of your ability:

6. In the past **6 weeks**, how many weeks and how many hours per week (on average) did you participate in a school PE class?

_____ number of weeks _____ hours per week

7. Based on the past **6 weeks** of activity, did you participate in any sports on a weekly basis (**NOT** including PE class)?

Yes No

If **yes**, please estimate the average number of hours per week you participated in each sport:

SPORT	hrs/week	SPORT	hrs/week	SPORT	hrs/week
Aerobics		Floor hockey		Skateboarding	
Alpine skiing		Football		Snowboarding	
Badminton		Golf		Soccer	
Baseball		Gymnastics		Squash	
Basketball		Hiking/ Scrambling		Speed skating	
Boxing (incl. kick)		Hockey		Swimming	
Cross-country skiing		Horse riding		Tennis	
Cycling (road or mtn)		Lacrosse		Track and field	
Dance		Martial arts		Volleyball	
Dirt biking		Rock climbing		Waterpolo	
Diving		Rollerblading		Weight training	
Field hockey		Rugby		Wrestling	
Figure skating		Running		*Other:	
				*Please describe:	

Appendix B: Injury Report Form

Dinos Sport Therapy Service



INCIDENT REPORT FORM

Athlete's Name: _____ **Age:** _____ **Home Phone #:** _____
Name of Event: _____ **Sport:** _____
Location of Event: _____ **Date of Injury:** _____
Team Name: _____

Hx: Please be as specific and thorough as possible

Obs:

Functional Tests include all tests performed

Special Tests include all tests performed:

Palpation:

Index of Suspicion: _____
 Side Region Type of Injury (ie: Rt AC Joint-2°sprain)

Management: _____

Follow-up: _____

Did you explain the tests and your impression/assessment to the patient?	Yes	No
Did you explain the objective(s) of the treatment to the patient?	Yes	No
Did the patient provide informed consent to the treatment?	Yes	No

Advice: Remain in Activity Return to Activity After Treatment Remove from Play

Referral: Physician Dentist Athletic or Physical Therapist Hospital or Medi-Clinic
 Other (specify): _____

Parent/Coach Signature if the athlete did not accept your advice: _____

*If patient under 18, parent or guardian

 Certification Candidate Signature

 Certified Therapist Signature

 Date

Appendix C: Weekly Exposure Form



Canadian Intercollegiate Sport Injury Registry*

Weekly Exposure Sheet High School Football Study 2009

Team: _____

Week of: _____

		Monday	Tuesday	Wednesday	Thursday	Friday											
Date (Month/Day)		/	/	/	/	/											
Session (Game=G, Practice=P)																	
Game Outcome (Win=W, Loss=L)																	
Duration (0.0 hours)																	
Session Description (ie, regular game, playoff game, practise)																	
PC Please enter a participation code (PC) for each player indicating: F Full (75%) P Partial (<75%) O None [0]	Athlete	PC	R	IID	PC	R	IID	PC	R	IID	PC	R	IID	PC	R	IID	
R (Reason) If athlete is NOT fully participating (i.e. coded "P" or "O") please indicate if they are: I Injured in football (Note MUST complete Injury Report Form) N Non-football related injury (Note do not need to complete Injury Report Form) S Sick O Other																	
IID (Injury ID #) specifies injury report form ID # to time loss																	

